



NOGA
simply sophisticated

Innovation is the beneficial utilization of knowledge and creativity,
in order to discover and realize what does not yet exist.

Erik Keldmann

Noga is innovation



Noga Head Office



NOGA ENGINEERING & TECHNOLOGY (2008) LTD

Noga Engineering and Technology was established in 1980. Over the years the company has grown to become the world leader in the manufacturing of three main lines:

Deburring Systems ■ **Holding Systems** ■ **Cutting Fluid Applicators** ■

Noga's strongest points are product design and development, quality and service. Our products are sold in more than 60 countries either through our own companies or a network of exclusive agents.



All NOGA products meet the strict requirements of ISO 9001 and ISO 14001.

We invite you to visit our web site: www.noga.com for further information.

NOGA reserves the right to make changes in any of its products without prior notice.

© Copyright NOGA Engineering & Technology (2008) Ltd.

WARNINGS   

- Blades are sharp and can cut.
- Blades can break causing flying shards.
- Sharp edges and flying shards can cause injury.
- Wear safety goggles (both user and bystanders).
- Do not pry or bend blades.
- Keep away from children.
- Do not regrind blades.

All rights reserved. No part of this publication may be reproduced, transcribed, stored in an electronic retrieval system, translated into any language or computer language, or be transmitted in any form whatsoever without the prior written consent of the publisher.



Main Content

DEBURRING SYSTEMS

1-65

HOLDING SYSTEMS

66-111

COOLING SYSTEMS
CUTTING FLUID APPLICATORS

112-124

INDEX

125-126

Deburring Tools



NOGA
simply sophisticated

Contents

HEAVY DUTY 3-8

Noga Burr 3
Noga Burr 5
Super Burr
Edge Off
Rapid Burr
Plastic Edge Off
Plastic Rapid Burr
NogaGrip 1 Handle
NogaGrip 3 Handle
S Holder
S Blades
Heavy Duty S Blade Sets

LIGHT DUTY 9-14

Magic Burr 2
Magic Burr 4
Tele Burr
TeddyBurr
NogaGrip 2 Handle
NogaGrip 3 Handle
N Holder
N Blades
Light Duty N Blade Sets

COUNTERSINKS 15-26

Countersinks
Heavy Duty Rotodrive
Heavy Duty Ex. Rotodrive
NogaGrip 3 Handle

H.D. Rotodrive Holder
H.D. Ex. Rotodrive Holder
C Holder
C Blades
Rotodrives
Ex. Rotodrive
Quick Connect Rotodrive
NG-1 Handle
Cranked Quick Connect Holder
RD Blades
Reversible Countersinks
Mini Reversible
Medium Reversible
Large Reversible
R Blades
Countersink Sets

SCRAPERS 27-30

Mini Scraper YT
Scraper YT
Scraper
H.D. Scraper
Mini Scraper NG
Internal Scraper
Triangular Scraper
NogaGrip 3 Handle
YT Handle
SC Handle
D Holder
TN Holder
D and T Blades

DIAMOND FILES 31-32

YT Handle
DT Blades
YT Sets

DOUBLE EDGE 33-36

Keyway Burr
Noga O-Ring
Noga V Cut
Noga Mini Cut
Double Burr
NogaGrip 1 Handle
NogaGrip 3 Handle
K Holder
L Holder
N & L Blades and O-Ring

SINGLE EDGE 37-38

Corner Cleaner
Thread Cleaner
Slot Cleaner
Leader
NogaGrip 1 Handle
NogaGrip 3 Handle
L Holder
L & TC Blades

CERAMICS 39-44

Noga Soft Cut
Noga Hard Cut
Noga Cera-Cut

Convexed Cera-Cut
Concaved Cera-Cut
Mini Ceramic
Adjustable mini Ceramic
Ceramic Double Burr
Noga-Cut Handle
Cera-Cut Handle
Ceramic Mini handle
Ceramic Mini Scraper
CR Blades
Ceramic Sets

SETS & KITS 45-50

The Platinum Set
The Gold Set
Noga Set
The Agent Set
Silver Unikit
Bronze Unikit
The Mini Kit
Trouble Shooter Set
Noga 007
Fine Mini Set
Rapid Burr Magic Set
The Counter Display
Noga Burr Display
Popular Tools Display
Tool and Blade Collection

SPECIALTY TOOLS 51-54

Multi Burr
Non Scratch
Non Scratch Blade
Soft Grip
Universal Handy Chuck Holder
Liza Burr
Scraper

SPECIALTY BLADES 55-56

S Blades
N Blades

CHIP HOOKS 57-59

Chip Hook Fixed
Chip Hook Fixed with Shovel
Chip Hook Set
Chip Hook Modular
Chip Hook Modular with Shovel

PLUMBING 60-65

Spider Burr
Inner-Outer Reamer for Plastic
Inner-Outer Reamer for Steel
Inner-Outer Reamer for Soft Metals
Edge-Off
Rapid Burr
Noga Burr 1, 3

Heavy Duty Applications



Heavy Duty

NOGA BURR 3 NG1003

Will do most of your deburring jobs.
INCLUDES: NG-1 handle, S10, S20 and S35 blades.

NOGA BURR 5 NG1005

Same as NG1003 with 2 extra blades.
Suitable for coarse to extra fine deburring operations.
INCLUDES: NG-1 handle, S10, S20, S35, S101 and S202 blades.



SUPER BURR NG3003

For heavy duty jobs.
INCLUDES: NG-3 handle, S holder, S100, S20 and S30 blades.



EDGE OFF EO1000

Disposable tool. A handy pocket clip is a standard feature of this tool.
INCLUDES: S10 blade mounted in an 8 mm painted hexagonal aluminum handle.



RAPID BURR RB1000

Steel housing for long life of handle.
The blade is replaceable.
INCLUDES: S10 blade mounted in an 12 mm painted hexagonal aluminum handle.



PLASTIC EDGE OFF EO2000

Most competitive tool. Holds all S blades (3.2mm).
The blade is replaceable.
INCLUDES: S10 blade and plastic handle.



PLASTIC RAPID BURR RB1400

Holds all S blades (3.2mm). The blade is replaceable.
INCLUDES: S100 blade and plastic handle.



Heavy Duty S Blades



Handles S Blades

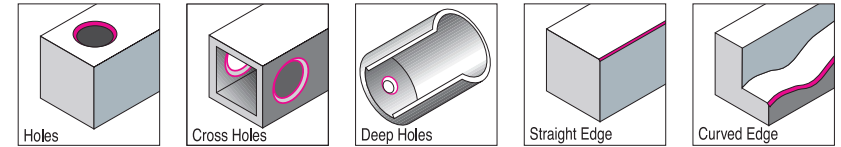

NG-1 Handle NG1000

NogaGrip-1 - holds all S blades (3.2 mm).
Spare blades can be kept inside the handle.
Designed for maximum comfort in your hand.



NG-3 Handle NG3000

NogaGrip-3 - holds all blade holders.
Spare blades can be kept inside the handle.
Designed for maximum comfort in your hand.



S Holder EL02003

Holds S blades (3.2 mm). S holder
telescopes from 30-115 mm.
Length 131 mm.



BLADES

BLADES	order no.		incl. angle (degrees)	package weight (g)	package quantity	works best on:
S10	BS1010		BEST SELLER 40	42	10	steel, aluminium and plastic
S10TiN	BS1012		40	42	10	abrasive material
S20	BS2010	L/R	BEST SELLER 60	43	10	brass and cast iron
S20TiN	BS2012	L/R	60	43	10	stainless steel
S30	BS3010		40	40	10	both int. and ext. burrs
S35	BS3510	L/R	BEST SELLER 55	44	10	straight edges on most materials
S60	BS6001		40	9	1	cross holes in difficult to reach places
S70	BS7001		45	8	1	straight edges and flat surfaces
S100 Cobalt	BS1018		BEST SELLER 45	42	10	plastic and hard materials
S101	BK1010		40	39	10	fine edges on all materials
S150	BK3010		BEST SELLER 45	37	10	holes as small as 1.5 mm dia.
S150 TiN	BK3112		45	37	10	holes as small as 1.5 mm dia. for long life
S202	BK2010	L/R	55	40	10	brass and cast iron fine edges

L/R - for left and right hand users.

All blades are made of H.S.S. Hardness 62-64Rc except S100 Cobalt 65-66Rc

Heavy Duty S Blade Sets



Promo Set NG8150
INCLUDES:
NogaGrip-1- handle - NG1000
10 pcs. S10 blades - BS1010



Economy Set NG8200
INCLUDES:
NogaGrip-1- handle - NG1000
20 pcs. S10 blades - BS1010



Cobalt Set NG8250
INCLUDES:
NogaGrip-1- handle - NG1000
20 pcs. S100 blades - BS1018



Tele Set NG8350
INCLUDES:
NogaGrip-3 - handle - NG3000
S Holder EL02003
5 pcs. S10 blades - BS1010
5 pcs. S20 blades - BS2010



Golden Set NG8152

INCLUDES:
 NogaGrip-1- handle - NG1000
 10 pcs. S10 TiN blades - BS1012

Golden Set NG8162

INCLUDES:
 NogaGrip-1- handle - NG1000
 10 pcs. S20 TiN blades - BS2012



Trio Set RB3000

INCLUDES:
 RB handle + S10 blade - BS1010
 (red for brass & iron cast)
 RB handle + S100 cobalt blade - BS1018
 (blue for steel & aluminium)
 RB handle + S150 blade - BK3010
 (yellow for plastic)



Universal Set E02100

INCLUDES:
 EO handle + S10 blade - BS1010
 (green for aluminium)
 EO handle + S20 blade - BS2010
 (red for brass and iron cast)
 EO handle + S100 blade - BS1018
 (blue for steel)
 EO handle + S150 blade - BK3010
 (yellow for plastic)



Multi Blades Set BS9999

INCLUDES:
 S10 - BS1010, S20 - BS2010,
 S30 - BS3010, S35 - BS3510,
 S60 - BS6001, S70 - BS7001,
 S100 Cobalt - BS1018,
 S101 - BK1010, S150 - BK3010,
 S202 - BK2010

Light Duty Applications

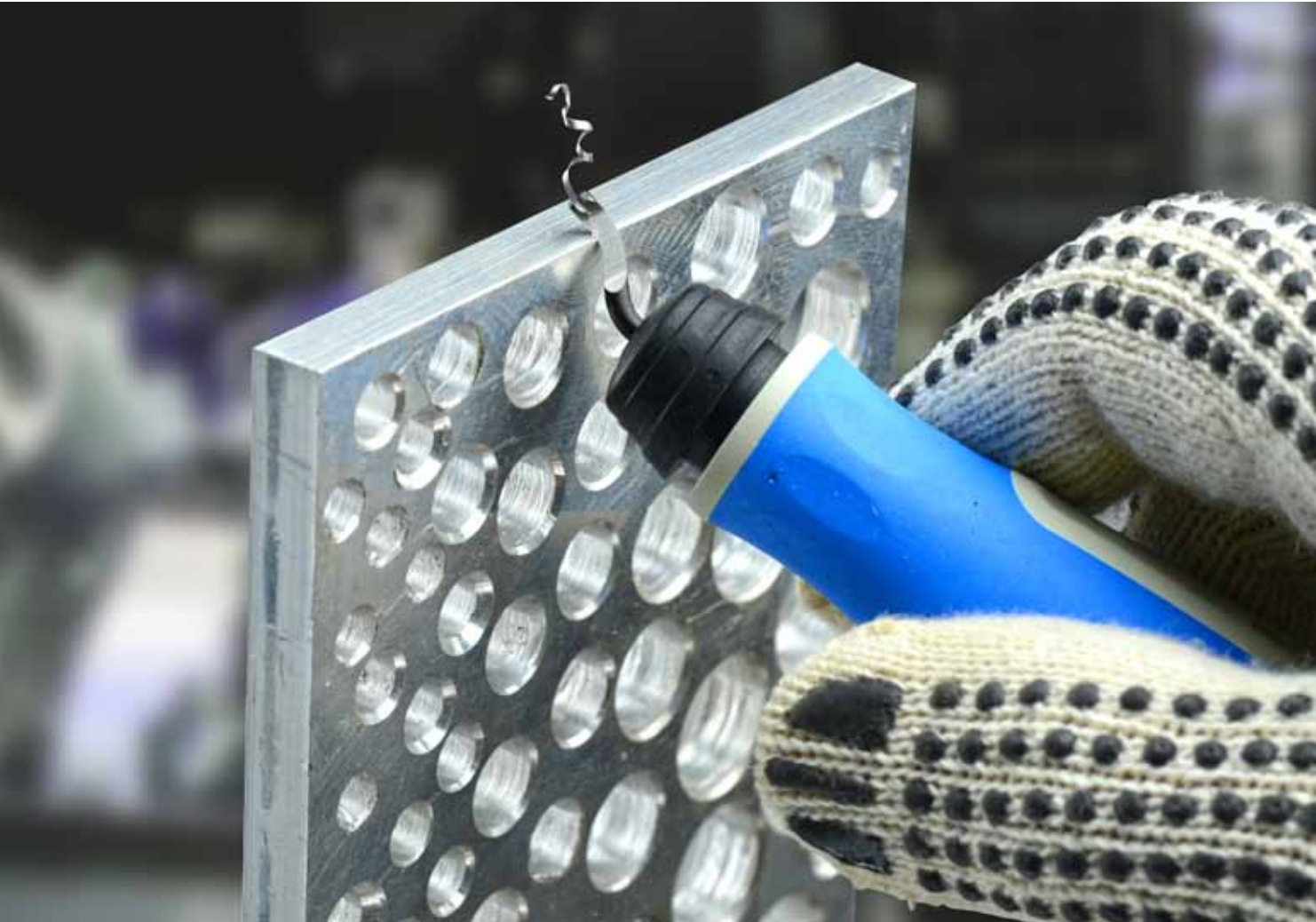

Light Duty

MAGIC BURR 2 NG2002

Will do most of your deburring jobs.

INCLUDES: NG-2 handle, N1 and N2 blades.

MAGIC BURR 4 NG2004

Same as NG2002 with 2 extra blades for cross holes in difficult to reach places.

INCLUDES: NG-2 handle, N1, N2, N3 and N6 blades.



TELE BURR NG3002

Very popular tool. Holds 2.6 mm N blades.

INCLUDES: NG-3 handle, N holder, N1 and N2 blades.



TEDDY BURR TB1000

Design for hard to reach locations. Blade is replaceable.

Steel housing for long life of handle.

INCLUDES: N1 blade mounted in an 8mm painted hexagonal aluminum handle.



Light Duty N Blades



Handles N Blades

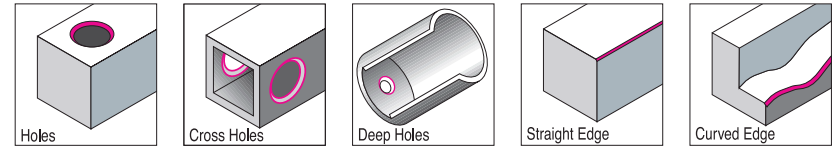

NG-2 Handle NG2000

NogaGrip-2 - holds all N blades (2.6 mm). Spare blades can be kept inside the handle. Designed for maximum comfort in your hand.



NG-3 Handle NG3000

NogaGrip-3 - holds all blade holders. Spare blades can be kept inside the handle. Designed for maximum comfort in your hand.



N Holder EL01033

Holds N blades (2.6mm). N holder telescopes from 25-115 mm. Length 131 mm.



BLADES

BLADES	order no.		incl. angle (degrees)	package weight (g)	package quantity	works best on:
N1	BN1010	 	40	13	10	steel, aluminium and plastic
N1 TiN	BN1012		40	13	10	abrasive material
N2	BN2010	L/R  	80	14	10	brass and cast iron
N2 TiN	BN2012	L/R 	80	14	10	stainless steel
N3	BN3010		50	12	10	both int. and ext. burrs
N6	BN6001		40	6	1	cross holes in difficult to reach places
N10 Cobalt	BN1310	 	45	13	10	plastic and hard materials

L/R - for left and right hand users.

All blades are made of H.S.S. Hardness 62-64Rc except N10 Cobalt 65-66Rc

Light Duty N Blade Sets



Promo Set NG8000

INCLUDES:
NogaGrip 2 handle - NG2000
10 pcs. N1 blades - BN1010



Economy Set NG8050

INCLUDES:
NogaGrip 2 handle - NG2000
20 pcs. N1 blades - BN1010



Cobalt Set NG8100

INCLUDES:
NogaGrip 2 handle - NG2000
20 pcs. N10 cobalt blades - BN1310



Tele Set NG8300

INCLUDES:

- NogaGrip 3 handle - NG3000
- 1 pc. N holder - EL01033
- 5 pcs. N1 blades - BN1010
- 5 pcs. N2 blades - BN2010



Golden Set NG8002

INCLUDES:

- NogaGrip 2 handle - NG2000
- 10 pcs. N1 TiN blades - BN1012

Golden Set NG8402

INCLUDES:

- NogaGrip 2 handle - NG2000
- 10 pcs. N2 TiN blades - BN2012



B10 Set SG6000

INCLUDES:

- NogaGrip 2 handle - NG2000
- 20 pcs. B10 blades - BN1311

Countersink



Heavy Duty

COUNTERSINK NG3100

The standard tool for countersinking.
Useful for chamfering deep holes.

INCLUDES: NG-3 handle, C holder and C20 countersink (20 mm).



HEAVY DUTY ROTODRIVE NG3400

40 mm displacement allows for heavy duty burrs to be removed. Continuous rotation of countersink enables very fast chamfering.

INCLUDES: NG-3 handle, H.D. cranked RotoDrive holder and C20 countersink (20 mm).



HEAVY DUTY EXTERNAL ROTODRIVE NG3500

Chamfers the O.D. on bars and tubes.
Range: 8-28 mm.

INCLUDES: NG-3 handle, H.D. external RotoDrive holder and EX28 countersink.



Countersink C Blades



Handles C Blades

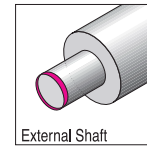
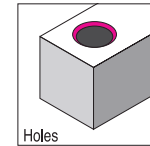

Work best on steel, aluminum and plastic. TiN coated blades have a vastly extended blade life

NG-3 Handle NG3000

NogaGrip-3 - holds all blade holders.
Designed for maximum comfort in your hand.



H.D. Rotodrive Holder EL0802

Heavy duty cranked holder. External M7 thread to hold: C12, C20 and C30 countersinks
Working dia. 80 mm







H.D. Ex. Rotodrive Holder EL0902

Heavy duty cranked holder. Accepts EX28 external countersink.
Working dia. 80 mm



BLADES

BLADES	order no.		range (mm)	angle (degrees)	package weight (g)	package quantity
C12	BC1211		1-12	90	24	1
C20	BC2011		3-20	90	28	1
C20TiN	BC2012		3-20	90	25	1
C30	BC3011		3-30	90	53	1
EX28	EX3001		8-28	90	17	1

All blades are made of H.S.S. Hardness 62-64Rc

C Holder CH3000

Holds C12, C20 and C30 countersinks. M7 external thread.
Has a hexagonal cross section to prevent rotating inside handle.
Length 131 mm.



Countersink Rotodrive



Classic Rotodrive

ROTODRIVE NG1200

The quickest way to chamfer. Single flute countersink provides a smoother cut. Range: 1-10.4 mm.

INCLUDES: NG-1 handle and Rotodrive RD 10.4 countersink.



EXTERNAL ROTODRIVE NG1700

Chamfers the O.D. on bars and tubes. Quickest way to chamfer O.D. on most materials. Range: 4-18 mm.

INCLUDES: NG-1 handle and Rotodrive EX 18 countersink.



ROTODRIVE NG1107

The quickest way to chamfer. Single flute countersink provides a smoother cut. Range: 1-20 mm.

INCLUDES: NG-1 handle and Rotodrive RD 20 countersink.



QUICK CONNECT ROTODRIVE NG1800

Quick connection to the tool blade holder. The quickest way to chamfer by hand. Single Flute Countersink provides a smoother cut. Range: 3-25 mm.

INCLUDES: NG-1 handle, cranked quick connect holder CH3300 and countersink blade BC 2511.



Countersink RD Blades



Handles RD Blades

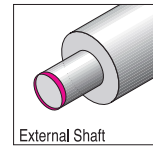
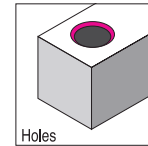

NG-1 Handle NG1000

NogaGrip-1 - holds all S blades (3.2mm).
Designed for maximum comfort in your hand.



Cranked Quick Connect Holder CH3300

3.2 mm shank



NEW DESIGN CONCEPT

Quick connect countersink blade



Work best on steel, aluminum and plastic. TiN coated blades have a vastly extended blade life

BLADES	order no.		range (mm)	angle (degrees)	package weight (g)	package quantity
RD3.2	BC3201		0-3	90	9	1
RD6.3	BC6301		1-6.3	90	9	1
RD8.3	BC8301		1-8.3	90	11	1
RD10.4	BC1041		1-10.4	90	14	1
RD10.4 TiN	BC1044		1-10.4	90	15	1
RD16.5	BC1651		1-16.5	90	33	1
RD20	BC2201		1-20	90	44	1
*RD25	BC2511		3-25	90	44	1
EX18	EX2001		4-18	90	15	1

* will fit holder **CH3300** only.

All blades are made of H.S.S. Hardness 62-64Rc

Countersink Reversible

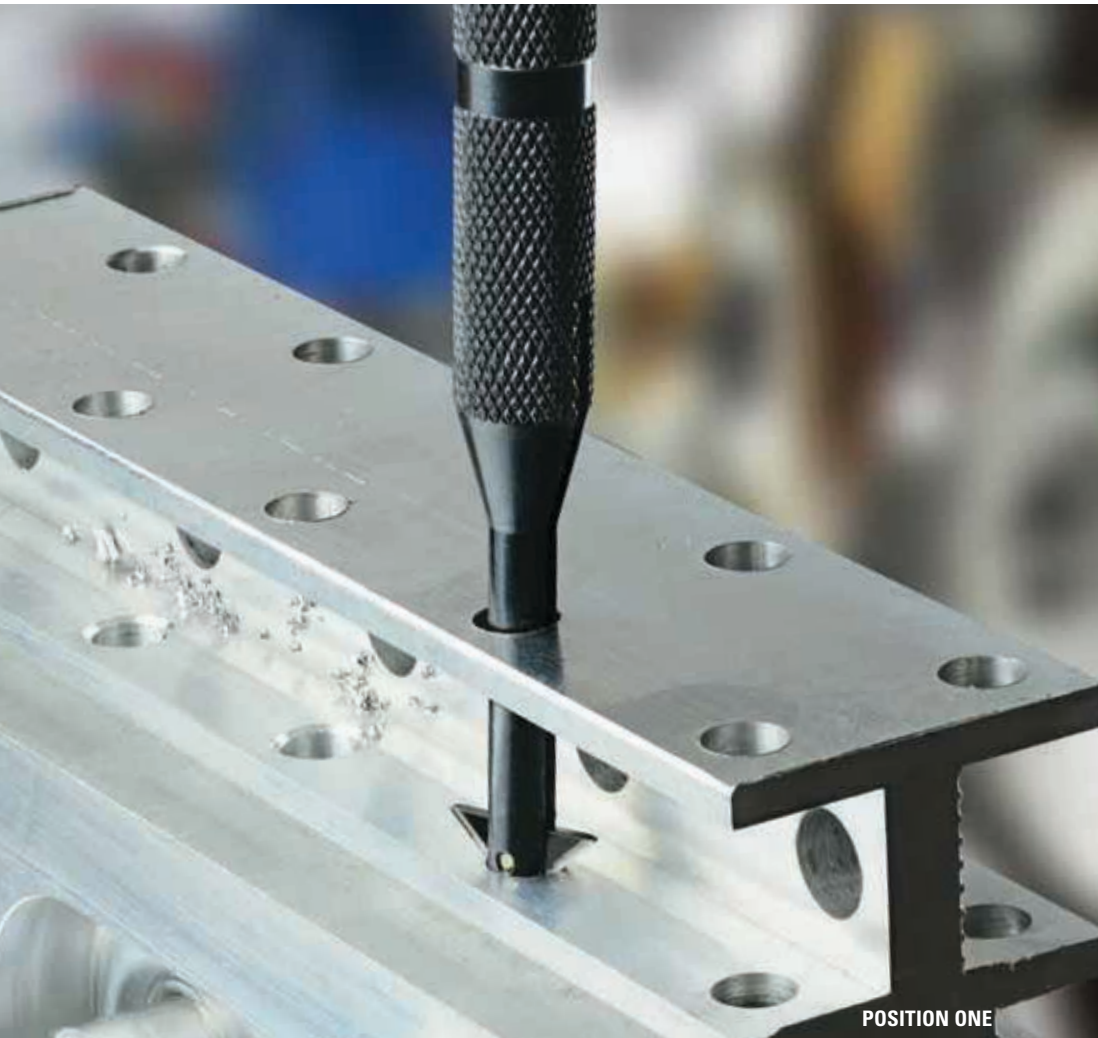

Handles

MINI REVERSIBLE RC1000

Very fine tool for deburring both back and front sides holes.

Range: 3-5.5 mm.

INCLUDES: Steel handle, R1 blade.



MEDIUM REVERSIBLE RC2000

Range: 5-10 mm.

INCLUDES: Steel handle, R2 blade.



LARGE REVERSIBLE RC2200

Range: 10-22 mm.

INCLUDES: Steel handle, R3 blade.

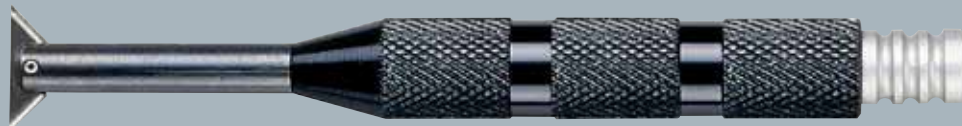

R Blades

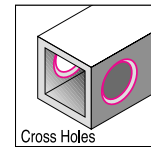
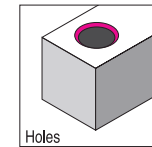

BLADES	order no.		angle (degrees)	range (mm)	package weight (g)	package quantity
R1	BR1001		90	3-5.5	4	1
R2	BR2001		90	5-10	5	1
R3	BR3001		90	10-22	6	1

All blades supplied with replacement screw

All blades are made of H.S.S. Hardness 62-64Rc

BLADE POSITION OPTIONS

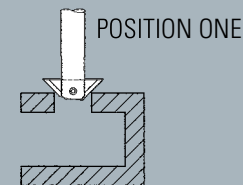

Deburring on external surface.

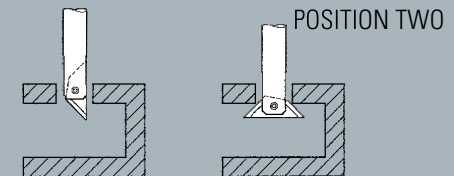

Deburring on internal surface via an opening. Rotate blade 90° from position one, enter opening, rotate again the blade another 90°.

TO REPLACE THE BLADE. The aluminium part at top of each handle conceals a suitable allen key. Pull it from the handle and use the key to remove and replace blade.

Countersink Sets



Rotodrive Countersink Set RD2010

INCLUDES:

- NogaGrip 1 handle - NG1000
- 1 pc. S10 blade - BS1010
- 1 pc. 3.2 countersink blade - BC3201
- 1 pc. 6.3 countersink blade - BC6301
- 1 pc. 8.3 countersink blade - BC8301
- 1 pc. 10.4 countersink blade - BC1041



Quick Connect Countersink Set NG1810

INCLUDES:

- NogaGrip 1 handle - NG1000
- 1 pc. cranked quick connect holder - CH3300
- 1 pc. RD25 int. countersink blade - BC2511
- 1 pc. EX28 ex. countersink blade - EX3001



Reversible Countersink Set RC3300

INCLUDES:

- 1 pc. Reversible RC1000
- 1 pc. Reversible RC2000
- 1 pc. Reversible RC2200



Countersink Power Tool Set CS7000

INCLUDES:

- 1 pc. connector for internal countersink - CH1950
- 1 pc. connector for external countersink - CH1970
- 1 pc. C12 int. countersink blade - BC1211
- 1 pc. C20 int. countersink blade - BC2011
- 1 pc. C30 int. countersink blade - BC3011
- 1 pc. EX28 ex. countersink blade - EX3001

Scrapers



Adjustable Scrapers

MINI SCRAPER YT1100

The best mini scraper for tool and die makers.
INCLUDES: YT handle and D75 HSS triangular mini scraper blade.



SCRAPER SC8000

Ideal for scraping, trimming and deburring most materials
INCLUDES: SC handle and T80 double ended medium triangular scraper blade.



MINI SCRAPER NG3700

Ideal for tool and die makers.
INCLUDES: NG-3 handle, D holder, D50 triangular mini scraper blade and a allen key.



SCRAPER YT1200

Ideal for scraping, trimming and deburring most materials.
INCLUDES: YT handle and T80 double ended medium triangular scraper blade.



HEAVY DUTY SCRAPER SC1500

Ideal for scraping, trimming and deburring most heavy duty materials.
INCLUDES: H.D. SC handle and T120 double ended triangular scraper blade.



TRIANGULAR SCRAPER NG3610

Ideal for standard scraping
INCLUDES: NG-3 handle, TN holder and T60 scraper.



INTERNAL SCRAPER NG3710

Ideal for cross-holes deburring.
INCLUDES: NG-3 handle, D holder, D66 internal scraper blade and allen key.



Scraper Blades



Handles D and T Blades

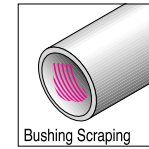
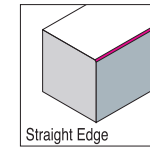
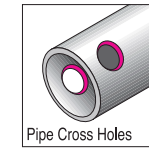
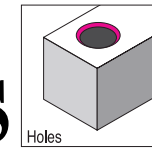

NG-3 Handle NG3000

NogaGrip-3 - holds all blade holders.
Designed for maximum comfort in your hand.



YT Handle YT1000

The perfect grip for Noga adjustable scrapers, needle files, pins and drills. Range: 2.2-4.5mm



SC Handle SC1300

Hexagonal black anodized 12 mm diameter handle with knurled locking collar for blade extension control. - holds D50, D66, D75, D77 and T80 scraper blades. Length 120 mm.



H.D. SC Handle SC1400

Hexagonal black anodized 14 mm diameter handle with knurled locking collar for blade extension control. Holds T120 scraper blade and screw bits. Length 130 mm.



BLADES

order no.		width x length (mm)	angle (degrees)	package weight (g)	package quantity	
D50	BD5010		2.5 x 50	60	37	10
D50TiN	BD5012		2.5 x 50	60	37	10
D55 Carbide	BD5501		2.5 x 50	60	9	1
D66	BD6610		2.7 x 50	50	44	10
D75	BD7501		2.5 x 75	60	8	1
D77	BD7701		2.7 x 75	50	9	1
T40	BT4001		4.2 x 40	60	7	1
T60	BT6001		7.4 x 60	60	11	1
T80	BT8001		4.2 x 80	60	11	1
T120	BT1200		7.4 x 120	60	24	1

All blades are made of H.S.S. Hardness 62-64Rc, except D55 Carbide 1400-1700 HV and T80, T120 CR115 58-60Rc

D Holder EL05003

Holds D scraper blades. A 3 mm setscrew - holds the blade in position. Allen key included. Length 131 mm.



TN Holder EL0608

Holds T40 and T60 scraper blades. NF10 Int. thread. Length 113 mm.



Diamond Needle Files and Sets

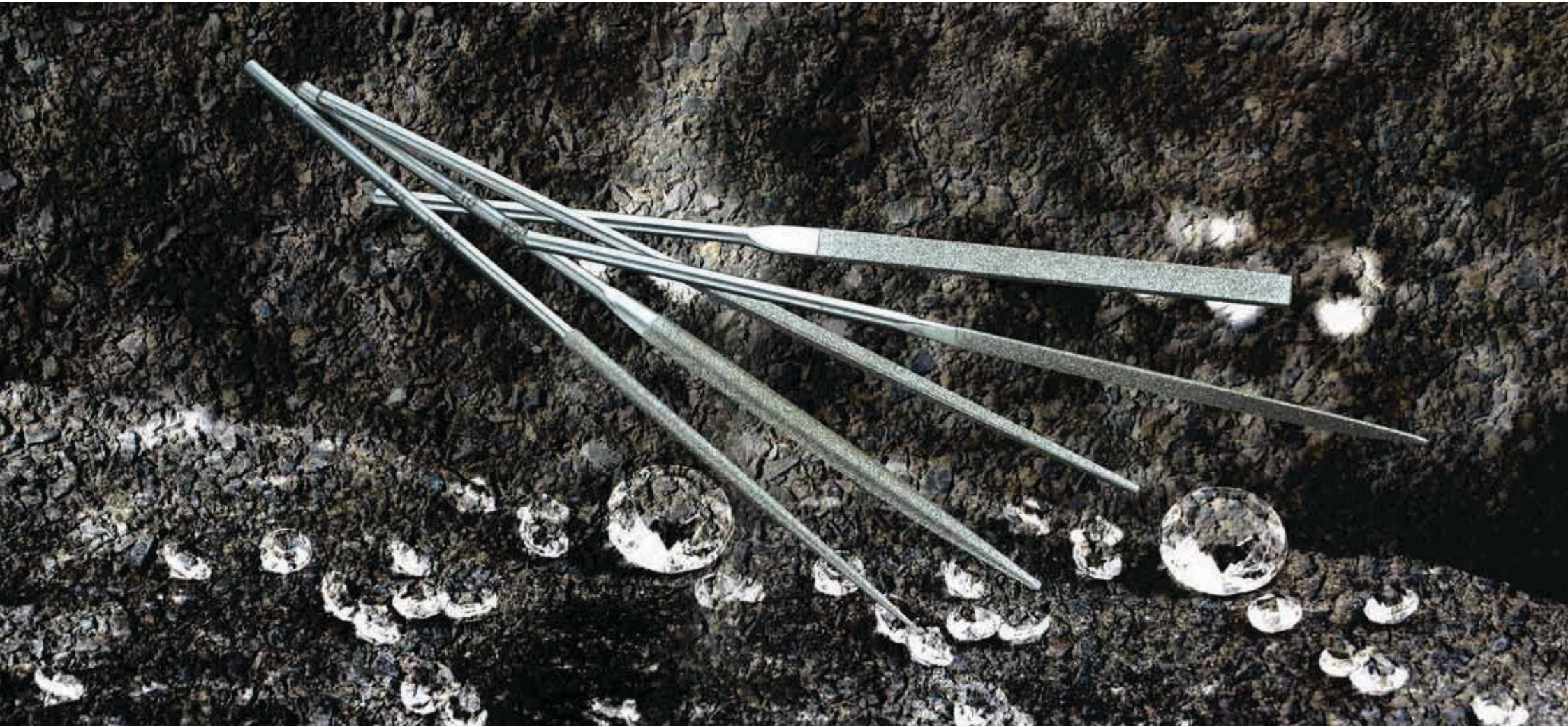

Handle

Files & Sets

The files are of Swiss made blanks electroplated with ultra high concentration of precisely graded diamond particles. A must for any tool and die shop, extruders and repairs of hardened alloys and ceramics.

YT Handle YT1000

The perfect grip for Noga adjustable scrapers, needle files, pins and drills.
Range: 2.2-4.5mm













YT 3000 Set

INCLUDES:
YT handle YT1000
1 pc. D75, T80 scraper
5 Files:
1 pc. DT1050, DT1051,
DT1052, DT1053, DT1054

YT 3300 Set

INCLUDES:
YT handle YT1000
5 Files:
1 pc. DT1050, DT1051,
DT1052, DT1053, DT1054



SHAPES	order no.		width x thickness (mm)
 Equaling	DT1050		5.1 x 1.4
 Triangular	DT1051		3.9
 Square	DT1052		2.5
 Half Round	DT1053		5.4 x 1.9
 Round	DT1054		3.0

All files are a total length 140 mm, with a 70 mm coated length. Shank size \varnothing 3 mm. Grit size: D126

Double Edge Cutting



Double Edge Cutting

NOGA KEYWAY-BURR NG3300

Efficiently removes burrs from internal and external keyways. Range: 2.4-11 mm.
INCLUDES: NG-3 handle, K holder and N80K blade.

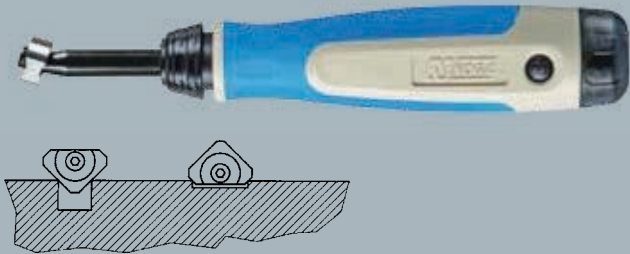

NOGA V CUT NG3200

For deburring sheet metal. Range: 1-8 mm.
INCLUDES: NG-3 handle, L holder and L3 blade.



NOGA MINI CUT NG3220

Used for deburring small ridges in difficult to reach places. Range: 0-2.5 mm.
INCLUDES: NG-3 handle, L holder and L4 blade.



NOGA O-RING BURR NG1100

Removes burrs from internal O-ring grooves. Range 0-3 mm (groove width).
INCLUDES: NG-1 handle and O-ring blade.



NOGA DOUBLE-BURR DB1000

Simultaneously removes burrs from both sides of sheet metal. DB handle with safety guard to protect your hand. Unique round cutting blades can be rotated and reversed for long life. For corners, use one blade only. Range: 0-12mm.
INCLUDES: DB handle, handguard and two N80 blades.

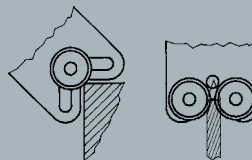

Double Edge Cutting Blades



Handles Blades

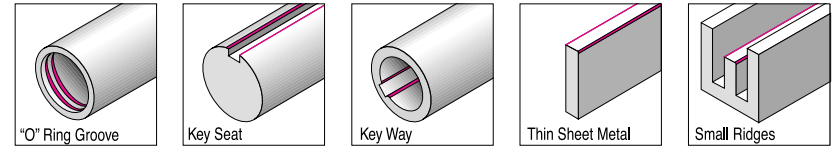

NG-1 Handle NG1000
 NogaGrip-1 - holds all blades (3.2mm).
 Designed for maximum comfort in your hand.



NG-3 Handle NG3000
 NogaGrip-3 - holds all blade holders.
 Designed for maximum comfort in your hand.











K Holder EL04003
 Holds K blades with M3 screw. Length 135 mm.



L Holder EL07013
 Holds L blades . Blades are held in a 3mm square hole and tightened with a 4 mm setscrew. Length 131 mm.



BLADES	order no.		range (mm)	angle (degrees)	package weight (g)	package quantity
N80	BN8010		0-12	55	34	10
N80M42	BN8043		0-12	55	32	10
N70K	BN7001		1.2-8	55	5	1
N80K	BN8110		2.4-11	55	31	10
N80KM42	BN8143		2.4-11	55	29	10
N90K	BN9009		3-15	55	8	1
L3	BL3001		1-8	50	6	1
L4	BL4001		0.5-2.5	50	6	1
O-Ring	BO1001		1-3	40	9	1

All blades are made of H.S.S. Hardness 62-64Rc except N80M42 and N80KM42, 66-68Rc

Single Edge Cutting



Single Edge Cutting

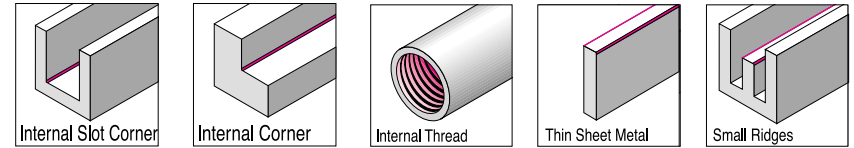

NG-1 Handle NG1000

NogaGrip-1 - holds all blades (3.2mm).
Designed for maximum comfort in your hand.



NOGA CORNER CLEANER NG3230

Effective corner relief. Wide range of applications.
INCLUDES: NG-3 handle, L holder and L6 blade.



NOGA SLOT CLEANER NG3210

Used to relieve corners of narrow slots from 3.5mm.
INCLUDES: NG-3 handle, L holder and L5 blade. (L7 double end blade for cutting in two directions is also available).



NG-3 Handle NG3000

NogaGrip-3 - holds all blade holders.
Designed for maximum comfort in your hand.



NOGA THREAD CLEANER NG1600

For cleaning damaged internal threads.
Minimum dia. 9 mm. Maximum thread pitch 3 mm.
INCLUDES: NG-1 handle and TC blade.



NOGA LEADER NG3800

Chamfering straight or curved edges. Ensures a 45° chamfer.
INCLUDES: NG-3 handle, LD holder and L1 blade.



L Holder EL07013

Holds L blades. Blades are held in a 3mm square hole and tightened with a 4 mm setscrew.
Length 131 mm.



TC Blade BC1001

Works best on damaged internal threads. Max 3 mm pitch



BLADES

BLADES	order no.		angle (degrees)	package weight (g)	package quantity	works best on:
L1	BL1001		45	5	1	steel and aluminium
L5	BL5001		65	5	1	slots from 3.5 mm
L6	BL6001		50	6	1	sharp corners
L7	BL7001		50	6	1	slots from 3.5 mm.
		Double ended				

All blades are made of H.S.S. Hardness 62-64Rc

Ceramic Applications



Ceramic

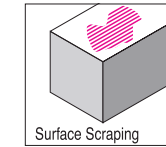
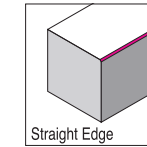
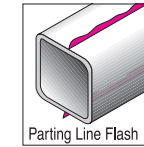
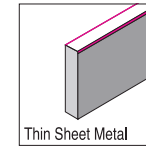
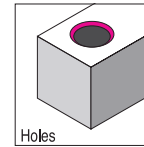

NOGA SOFT CUT TOOL NC5100

Ideal for deburring soft abrasive plastics
INCLUDES: NogaCut handle and NogaCut blade 65°.



NOGA HARD CUT TOOL NC5200

Ideal for deburring hard abrasive plastics.
INCLUDES: NogaCut handle and NogaCut blade 75°.



NOGA CERA-CUT CR1100

Ideal for deburring plastics and other soft materials.
Extremely long life. Disposable tool.
INCLUDES: 250mm convexed radius ceramic blade, mounted in ergonomically held handle with soft grip.



CONVEXED CERA-CUT CR2000

Perfect for all plastic materials and soft metals.
Ideal for surface scraping and parting line deflashing.
INCLUDES: Cera-cut handle and 250 mm convexed radius blade.



CONCAVED CERA-CUT CR2300

Perfect for all plastic materials and soft metals.
Ideal for curved edges and small ridges.
INCLUDES: Cera-cut handle and 15 mm concaved blade.



MINI CERAMIC CR1500

A unique mini plastic handle and convexed ceramic blade, perfect for plastic materials and soft metals.
Ideal for surface scraping and parting line deflashing.
INCLUDES: Mini Cera-cut handle and mini convexed blade.



ADJUSTABLE MINI SCRAPER CR4100

Ceramic mini scraper ideal for surface cleaning, trimming, deburring and parting line deflashing on most plastics.
Special blade design for safety.
INCLUDES: YT handle and mini ceramic scraper blade.



CERAMIC DOUBLE BURR DB5000

Ideal for simultaneously double edge deburring.
Range 1 - 11 mm.
INCLUDES: DB handle, hand guard and V-shaped ceramic blade.



Ceramic CR Blades



Handles Blades

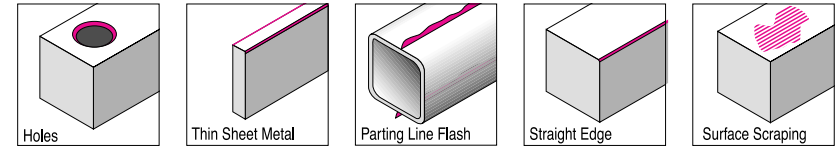

Noga-Cut Handle NC5000

Noga-Cut - ONLY - holds Noga-Cut blades CR6000 and CR6100.



Cera-Cut Handle CR2100

A unique plastic handle that holds the blade by its self-gripping taper. Storage space for spare blades.



Ceramic Mini Handle CR1400

A unique plastic handle that holds the blade by its self-gripping taper. Storage space for spare blades.



Ceramic Mini Scraper Handle

YT 10004

Perfect grip for adjustable ceramic mini scrapers.



BLADES

	order no.		angle (degrees)	package weight (g)	package quantity	applications:
Convexed	CR2200		90	12	1	surface cleaning and parting line deflashing
Concaved	CR2500		90	11	1	curved edges and small ridges
Mini Convexed	CR1550		90	2	1	surface cleaning, trimming on small parts deburring and parting line deflashing
Mini Scraper	CR4500	 Dimensions: 3.1 x 50mm	90	7	1	surface scraping and parting line deflashing
Soft Cut	CR6000		65	6	1	deburring soft abrasive plastics
Hard Cut	CR6100		75	6	1	deburring hard abrasive plastics
V-Shaped	CR5100		90	8	1	double edge burr removal

All blades are made of Ceramic 1250HV

Handles

Blade Placement

NogaCut Handle NC5000

NogaCut - ONLY - holds NogaCut blades CR6000 and CR6100.



To insert blade

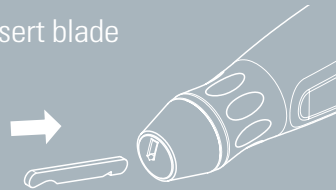

Push blade into aperture.

To replace blade

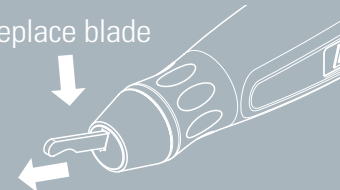

Press existing blade downward and release by pulling out.

Cera-Cut Handle CR2100

A unique plastic handle that holds the blade by its self-gripping taper. Storage space for spare blades.



To remove blade

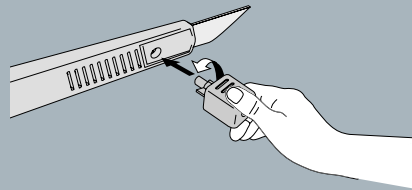

Remove end cap, insert point into hole and turn 90°. Release blade.

To insert blade

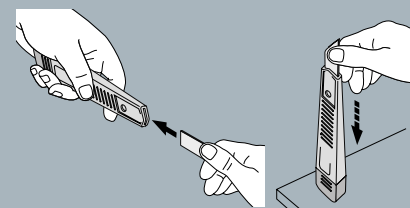

Insert blade into groove. Hold in place and gently tap against solid surface.

Ceramic Sets



Noga Cera-Cut Set CR3000

Includes:

Cera-Cut handle - CR2100

1 pc. NogaCut Convexed blade - CR2200

1 pc. NogaCut Concaved blade - CR2500



NogaCut Set CR5500

Includes:

NogaCut handle - NC5000

5 pcs. Noga Soft Cut blades 65° - CR6000

5 pcs. Noga Hard Cut blades 75° - CR6100

The Set Range

THE PLATINUM SET NG9500

The most suitable collection of **Deburring Tools** required for tool and die maker specialists.



INCLUDES:

Tools

Double Burr DB1000

Holders

S Holder EL02003

N Holder EL01033

C Holder CH3000

D Holder EL05003 (2 pcs.)

K Holder EL04003

Handles

NG-1, NG-3, TB handle

Blades

S10, S20, S30, S150,
N1, N2, C20, D50, D66,
N80K, EX18 & RD10.4

Allen Key (1.5mm).

THE GOLD SET NG9400

The complete collection of **Deburring Tools** required for professional machinists.



INCLUDES:

Tools

Adjustable Scraper SC8000

Holders

S Holder EL02003

N Holder EL01033

C Holder CH3000

D Holder EL05003

K Holder EL05003

Handles

NG-3, EO plastic handle

Blades

S10, S20, S30, S150,
N1, N2, C20, D50, D66,
N80K, and RD10.4.

Allen Key (1.5mm).

THE NOGA SET SP7700

The 7 most popular **Deburring Tools** you will need to carry for any deburring application.



INCLUDES:

Tools

Super Burr NG3003
Internal Scraper NG3710
Keyway Burr NG3300
Adjustable Scraper SC8000
V-Cut NG3200
Mini Scraper NG3700
Countersink NG3100

THE NOGA AGENT SET SK1000



INCLUDES:

Tools

DB1000, DB5000, EO1000, CR1100,
SC8000, RC1000, RC2000, RC2200.

Holders

S Holder, N Holder, C Holder, D Holder,
H.D. Rotodrive, H.D. Ext. Rotodrive,
K Holder, L Holder.

Handles

NG-1, NG-2, NG-3, CR, RB, TB.

S Blades - 3.2 mm

S10, S10TiN, S10 Carbide, S20, S30,
S35, S60, S70, S80, S101, S150, S202.
O-Ring, Thread Cleaner.

N Blades - 2.6 mm

N1, N1TiN, N1 Diamond, N1 Carbide,
N2, N2TiN, N2 Carbide, N3, N6, N10.

Cranked Countersinks

RD3.2, RD6.3, RD8.3, RD10.4, RD16.5.

Countersinks

C12, C20, C30.

External Countersinks

EX18, EX28.

Scrapers

D50, D55 Carbide, D66, D75, D77.

Double Edged Cutting Blades

N70K, N80K, N90K, L3, L4.

Ceramic Blades

CR2200, CR2500.

Kits

THE SILVER UNIKIT NG9300

Most suitable for **MRO**.



INCLUDES:

Tools

Reversible countersink RC2000

Handle

NG-3, EO plastic handle

Holders

S Holder EL02003

Blades

S10, S20, S30, RD3.2, RD10.4, RD16.5 and EX18

THE BRONZE UNIKIT NG9200

Most economical deburring kit for all machinists.



INCLUDES:

Handle

NG-3

Holders

S Holder EL02003

N Holder EL01033

C holder CH3000

D holder EL05003

Blades

S10, S20, S30, S150, N1, N2, C20 and D50. Allen Key

THE MINIKIT NG9100

Universal deburring kit for all machinists.



INCLUDES:

Handle

NG-3

Holders

S Holder EL02003

N Holder EL01033

Blades

S10, S20, S30, S150, N1 and N2

The Mini Range

NOGA TROUBLE SHOOTER SET SP1010

Compact set. Suitable for deburring, scraping and countersinking.



INCLUDES:

Handle

Short RB handle

Blades

S20, S100, S150, RD16.5, RDE18 and D50

NOGA 007 SET SP1007

Ideal for maintenance operator. Used for deburring, cleaning, finishing and countersinking.



INCLUDES:

Handle

Short RB handle

Blades

S20, S150, RD16.5, RDE18, O-ring and TC

FINE MINI SET FT3000

The handyman's mini set for deburring, scraping and countersinking.

INCLUDES:

FT10001 - S150 blade.

FT11001 - D50 scraper blade.

FT12001 - 3.2mm countersink blade.

Blades are not replaceable



THE RAPID BURR MAGIC SET RB4000

The Rapid Burr handle can hold either rotating or fixed blades.

INCLUDES:

RB handle

Blades: S10 and D50



Counter Displays



THE COUNTER DISPLAY SP7250

INCLUDES:

Tools

- 4 Pcs. Tele Burr NG3002
Super Burr NG3003
- 3 Pcs. Noga Burr-3 NG1003
Triangular Scraper NG3610
Mini Scraper NG3700
- 2 Pcs. Rapid Burr RB1000
Double Burr DB1000
Rotodrive NG1200
Reversible Countersink RC2000
Countersink NG3100
Noga Soft-Cut NC5100
Adjustable Scraper SC8000
- 1 Pc. External Rotodrive NG1700
Convexed Cera-Cut CR2000

Blades:

- 4 Packs Each (40 Blades)
S10 BS10102
S20 BS20102
N1 BN1010
N2 BN2010

NOGA BURR DISPLAY
NG9600 & NG9610



NG9600 INCLUDES:
20 pcs. Noga Burr-3 NG1003

NG9610 INCLUDES:
20 pcs. Noga Burr-5 NG1005

THE MOST POPULAR TOOLS DISPLAY
NG9700



INCLUDES:
Tools
4 pcs. Noga Burr-3 NG1003
Tele Burr NG3002
Super Burr NG3003
Countersink NG3100
Mini Scraper NG3700

THE TOOL AND BLADE COLLECTION DISPLAY
SP7300

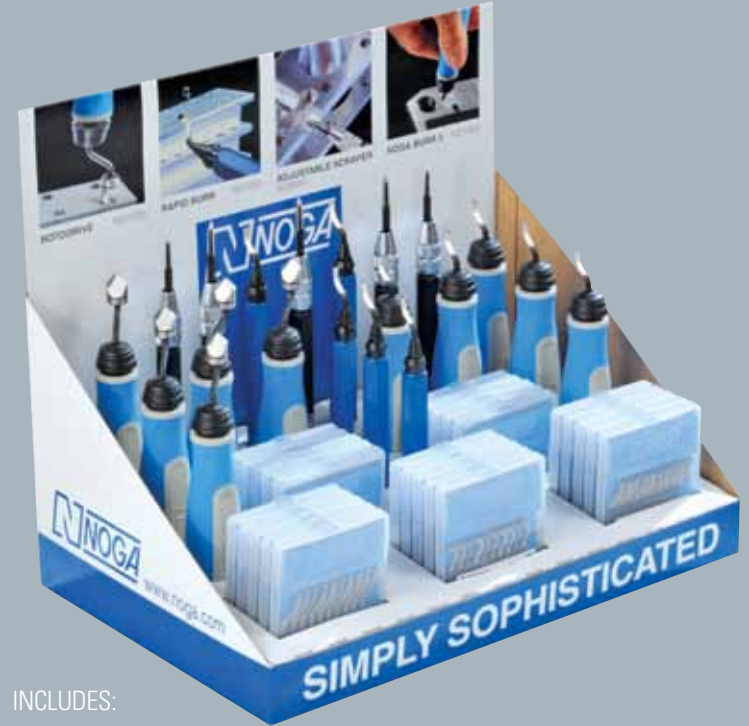

INCLUDES:
Tools:
5 pcs. Noga Burr-3 NG1003
Rotodrive NG1200
Adjustable Scraper SC8000
Rapid Burr RB1000

Blades:
5 packs (50 blades).
S10 BS1010, S20 BS2010,
S30 BS3010, S100 BS1018,
S150 BK3010

Specialty Tools

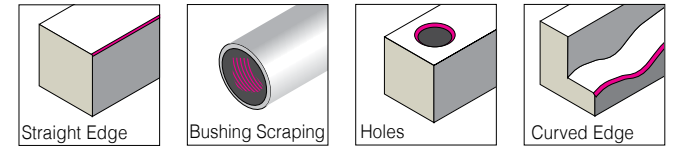

MULTIBURR RG1000

The handy universal deburring set with multi-purpose blades will help you produce a perfect finish for a wide variety of jobs.

This innovative tool set has 4 folding shafts which can be easily locked into position for the duration of the work and then folded neatly back into the handle allowing the tool to be carried simply anywhere.

S10 Blade

Works best on steel, aluminum and plastic

D50 Scraper Blade

Ideal for tool and die makers

10.4 mm Rotodrive Countersink Blade

Quickest way to chamfer.

Range 1-10.4 mm

N2 Blade

Works best on brass and cast iron





NON SCRATCH NG1910

Removing burrs from workpieces may sometimes leave unsightly scratches, Noga's NG-1 handle with the NEW non scratch blade with safety cap will prevent friction therefore eliminating scratches. Works best on steel, aluminum and plastic materials.

INCLUDES: NG-1 handle and S91 blade.



Non Scratch HSS Blade with safety cap BS9110

Plastic safety cap will protect workpiece surface from scratches.



Specialty Tools



SOFT GRIP SG1000

Ergonomically designed handle for ease of use.
At front end 2 holes can take both S and N blades.



INCLUDES:
SG handle, S100 and N10 Cobalt blades.

TO INSERT BLADE

1. Hold handle in left and blade right hand.
2. Push blade in and simultaneously turn blade CW.

TO REMOVE BLADE

1. Repeat as above but pull out.

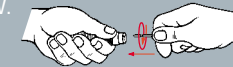

A wide variety of tools, blade holders and blades are available for use with the versatile Universal Chuck Handle.

UNIVERSAL HANDY CHUCK HOLDER PV1000

Aluminium handle with non-slip covering. A 3 jaw chuck helps with quick and secure clamping of a wide variety of tools, blade holders and blades for scrapers, countersinks, files etc.
Range: 0.8 - 8 mm.



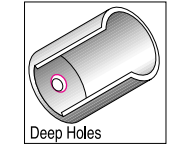
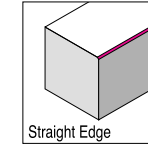
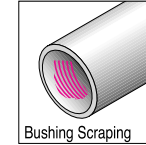
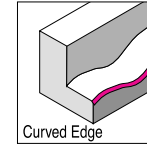
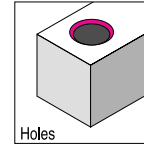

LIZA BURR LB1000

Double end blade holder to utilize both N and S blades.
Telescopes from:
20-110 mm with N blades
20-94 mm with S blades.



INCLUDES:
UNI handle, SN holder, N1 and N2 blades.

SCRAPER SC1000

Double end scraper for longer tool life.
Can be locked in required position.



INCLUDES:
UNI handle and T120 double ended triangular scraper.

Specialty S Blades

BLADES	order no.		works best on:
S10 Carbide	BS1016		hardened steel and plastic
S10 Diamond	BS1014		glass and ceramics
S10 LH	BS1011	LH 	steel, aluminium and plastic
S10 LH TiN	BS1013	LH 	steel, aluminium and plastic. For long life.
S100 TiN	BS1019		stainless steel and plastic. For long life.
S20 Carbide	BS2015	L/R 	hardened materials and plastic
S101 LH	BK1011	LH 	fine edges on all materials.
S101 TiN	BK1012		fine edges on all materials. For long life.
S30 TiN	BS3003		both int. and external burrs. For long life.
S60 TiN	BS6003		cross holes in difficult to reach places. For long life.
S80	BS8001		shallow steps
S80 TiN	BS8003		shallow steps. For long life.
S1500	BS1510		special blade for deburring rubber and soft materials

LH - for left hand users. L/R - for left and right hand users.

Blades are made of H.S.S. Hardness 62-64Rc, except S10 and S20 Carbide blades 1400-1700 HV and S100 Cobalt 65-66Rc.

Specialty N Blades

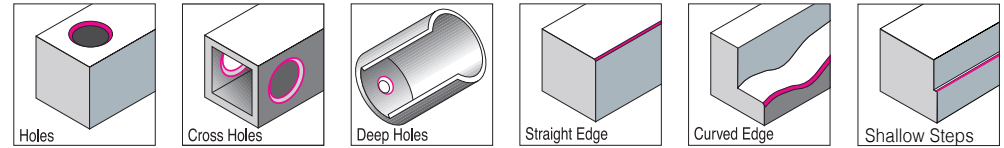

BLADES	order no.		works best on:
N1 Carbide	BN1029		hardened steel and special plastics
N1 Diamond	BN1028		glass and ceramics
N1 LH	BN1026	LH	steel, aluminum and plastic
N1 LH TiN	BN1027	LH	steel, aluminum and plastic. For long life.
N2 Carbide	BN2031	L/R	hardened steel and hard plastic

LH - for left hand users. L/R - for left and right hand users. Blades are made of H.S.S. Hardness 62-64Rc, except N1 and N2 Carbide blades 1400-1700 HV.

Chip Hooks



Chip Hooks - Fixed

Removes chips and cleans the chip trays on your machines. Black finished steel hooks. Includes a special $\varnothing 130\text{mm}$ guard to protect your hand. Fitted with a Noga Grip handle, designed for maximum comfort in your hand.

CHIP HOOK SP2500
Length 430 mm.



CHIP HOOK SP2550
Length 600 mm.



CHIP HOOK WITH SHOVEL SP2710
Length 430 mm.



CHIP HOOK WITH SHOVEL SP2720
Length 600 mm.



CHIP HOOK SET SP2700

INCLUDES:
1 pc. SP2500
1 pc. SP2550
1 pc. SP2600



SP2600

SP2500



SP2550



Chip Hooks - Modular

Removes chips and cleans the chip trays on your machines. Black finished steel hooks. This modular chip hook allows extensions of 200 mm increments from the standard length of 300 mm. Includes a special $\varnothing 130\text{mm}$ guard to protect your hand and extension rod. Fitted with a Noga Grip handle, designed for maximum comfort in your hand.

CHIP HOOK SP2510
Standard length 300 mm.

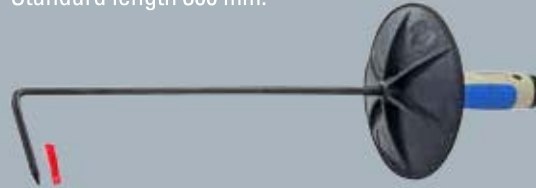

CHIP HOOK WITH SHOVEL SP2730
Standard length 300 mm.



CHIP HOOK SP2560
Length with added modular rod 500 mm.

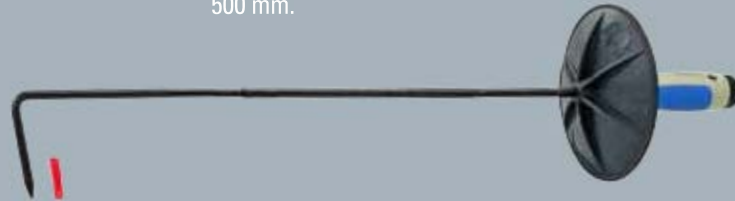

CHIP HOOK WITH SHOVEL SP2740
Length with added modular rod 500 mm.

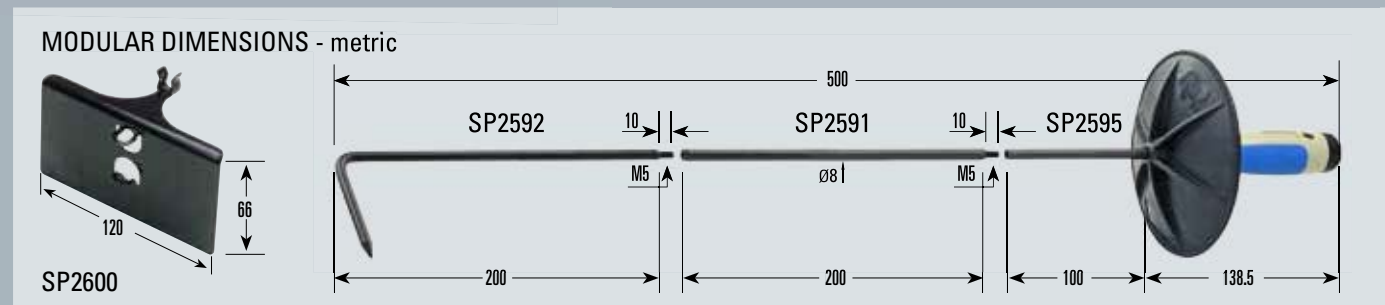

Plumbing Contents

SPIDER BURR 62

Spider Burr
Large Spider Burr

INNER - OUTER REAMER 63-64

Inner - Outer Reamer for Plastic
Inner - Outer Reamer for Steel
Inner - Outer Reamer for Soft Metals

DEBURRING TOOLS 65

Edge Off
Rapid Burr
Noga Burr 1, 3

Plumbing Tools





Spider Burr

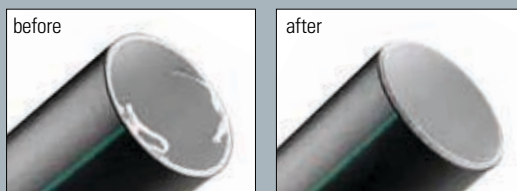

SELF ADJUSTING CHAMFERING TOOL

UNIQUE MECHANISM
ENABLES QUICK OUTER EDGE BURR REMOVAL
EXTREMELY FAST CHAMFERING ON EXTERNAL TUBES
IDEAL FOR THE OUTSIDE DIAMETER OF PLASTIC PIPES



EASY SET UP - the diameter of the Spider Burr automatically and quickly adjusts to the required outer circumference of the pipe.
Works on different plastic pipes and tubes such as UPVC, PVC, PP, PE, CPVC, ABS etc.
Working range: 75 - 110 mm (2½" - 4"), 110 - 160 mm (4" - 6").
Works best with standard electric/cordless drills - 14V and up.
For best performance run the drill at a low RPM.
Use the drill position setting.
Same blade is used for both models and is replaceable.

order no.	range	
PC2000	75 - 110 mm	2½" - 4"
PC3000	110 - 160 mm	4" - 6"
PC1100	Replacement blade	



Inner - Outer Reamer



FAST CHAMFERING UP TO 75 MM ON PLASTIC PC6000

Works on different plastic pipes and tubes such as UPVC, PVC, PP, PE, CPVC, ABS etc.

Working range: 25 - 75 mm ($3/4'' - 2\ 1/2''$).

Works best with standard electric/cordless drills - 14V and up.

For best performance run the drill at a low RPM.

Use the drill position setting.

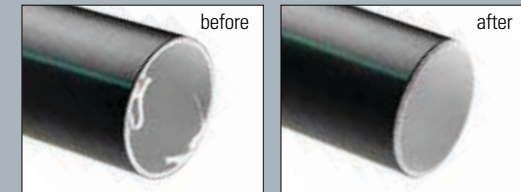

PC6000



order no.		range	
PC6000	EXT.	25 - 75 mm	$3/4'' - 2\ 1/2''$
	INT.	40 - 75 mm	$1\ 1/4'' - 2\ 1/2''$
PC6100	Replacement blade		

Inner - Outer Reamer

INNER - OUTER REAMER FOR PLASTIC & SOFT METALS SP81005

Deburs both the inner and outer edges
of tubing.
Plastic body with 3 cutters.
Reamer for plastic and soft metals.



SP81005

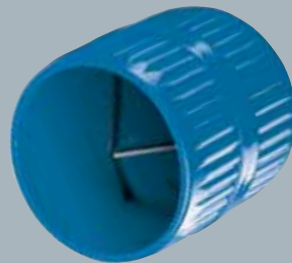

order no.	range	
SP81005	4 - 42 mm	$\frac{5}{32}$ " - $1 \frac{21}{32}$ "

INNER - OUTER REAMER FOR STEEL SP8200

The multiple cutting edges of the
SP 8200 on interior cone allows for
fast, clean, inner reaming and outer
deburring / beveling of steel tubing.
Hardened steel construction.



SP8200



order no.	range	
SP8200	12 - 50 mm	$\frac{1}{2}$ " - 2"

Deburring Tools

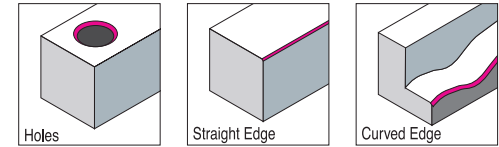

EDGE OFF EO1000

Disposable tool. A handy pocket clip is a standard feature of this tool.

INCLUDES: S10 blade mounted in an 8 mm painted hexagonal aluminum handle.



RAPID BURR RB1000

Steel housing for long life of handle.

The blade is replaceable.

INCLUDES: S10 blade mounted in an 12 mm painted hexagonal aluminum handle.

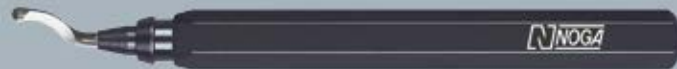

NOGA BURR 1 & 3

Will do most of your deburring jobs.



NOGA BURR 1 - NB1100

INCLUDES:

NB handle and S10 blade.

NOGA BURR 3 - NB3000



INCLUDES:

NB handle

S10, S20 and S35 blades.



BLADES

order no.		incl. angle (degrees)	package weight (g)	package quantity	works best on:
S10	BS1010	 40	42	10	steel, aluminium and plastic
S20	BS2010	L/R  60	43	10	brass and cast iron
S35	BS3510	L/R  55	44	10	straight edges on most materials

L/R - for left and right hand users.

All blades are made of H.S.S. Hardness 62-64Rc.



Main Content

DEBURRING SYSTEMS

1-65

HOLDING SYSTEMS

66-111

COOLING SYSTEMS
CUTTING FLUID APPLICATORS

112-124

INDEX

125-126

Holding Systems



NOGA
simply sophisticated

Contents

INTRODUCTION	69-70	SPECIAL HOLDERS	93-94
		Unique arms with plastic fine adjustment for EDM and vacuum base for granite surfaces	
ARTICULATED HOLDERS FAT	71-74	POST HOLDERS FAT	95-98
Noga articulated holders with fine adjustment at top		Noga PH holders are the latest improvement of the traditional indicator holder with fine adjustment on top	
ARTICULATED HOLDERS FAB	75-78	POST HOLDERS FAB	99-102
Noga articulated holders with fine adjustment at base		PH holders with Noga unique fine adjustment at base	
ARTICULATED HOLDERS FAT & FAB	79-82	MODULAR HOLDERS	103-104
Noga articulated holders with fine adjustment at top and base		Six different sizes of articulated arms	
SETS & INDICATORS	83-84	BASES	105-106
Noga offers three sets combining the most popular holder with the world's best made indicators		Nine different magnets ranging from the world's smallest to a large magnetic base and 5 clamps	
CENTERING HOLDERS	85-88	ACCESSORIES	107-110
		Top attachments, Adaptors, 3 Point Clamps, Knobs, Screws and Clamps	
MINI HOLDERS	89-92		

Introduction

NOGA is proud to present its new catalog of holding systems.

These state of the art mechanical holders, are divided into two groups, ARTICULATED and PH, both designed to hold dial and test indicators, as well as many other components.

NOGA holders are also used in many other fields such as: machine construction, medical instruments, photography, light, sound and more.

NOGA holders consist of three main parts: Arms, base and top (See diagram on right).

NOGA ARTICULATED HOLDERS - articulated arms, with central locking mechanism.

NOGA PH HOLDERS - post and arm, with unique 3 points clamp.

Each group of holders consists of several sizes of arms, so you can always find one to suit your needs.

NOGA holders have fine adjustment mechanism, whether it is on the top (FAT), or at the base (FAB) or both.

NOGA top fine adjustment is made of metal, and is the only fine adjustment to hold 6mm, 8mm, 3/8" and dove tail.

NOGA SPECIALTY HOLDERS - unique individual items. These are Noga well known items.

NOGA SETS - 3 sets of holders and indicators.

NOGA BASES - different magnetic bases from 200 N to 1300 N, a 350 N vacuum base, and clamps.

NOGA MODULAR HOLDERS - another useful addition to this catalog is the modular holders section which allows the user almost unlimited range of holding applications.

NOGA Accessories - A variety of accessories are shown. Custom made accessories are available upon request.



Choosing the Right Holder

- Choose the kind of arms needed, articulated or PH (Post Holder).
- When zero-setting is very important, use fine adjustment at base (FAB). In all other cases use fine adjustment on top (FAT).
- Decide what kind of base you want. Magnetic, vacuum or others.
- Depending on the type of indicator and job to be inspected, choose either standard clamp or NOGA fine adjustment with unique swivel clamp.
- Consult the relevant section in this catalog to choose the right holder.

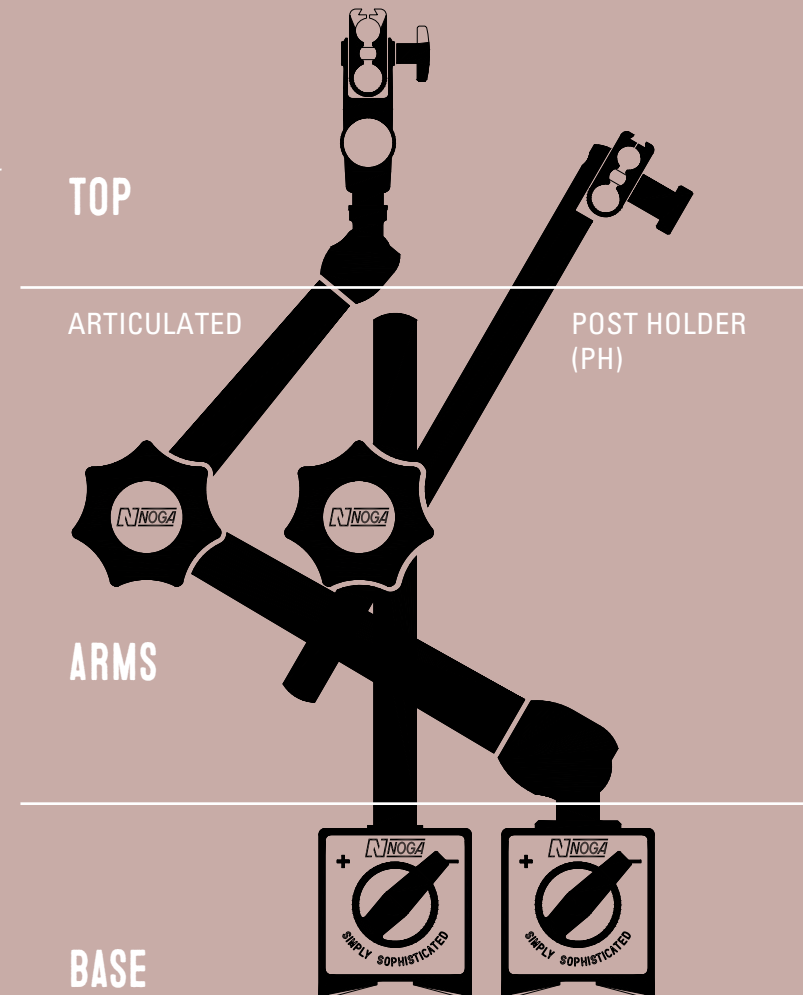

Articulated Holder FAT*



*Fine Adjustment Top



MA61003

Overall arm length 580 mm



MG71003

Overall arm length 347.50 mm



MG61003

Overall arm length 317 mm



DG61003

Overall arm length 282 mm



NF61003

Overall arm length 178 mm

Articulated Holders FAT*



NOGA articulated holders with fine adjustment on top

Due to its stability and ease of use, **NOGA** articulated holder has become the industry most wanted.

- Fine adjustment on top with universal swivel clamp.
- Holds 6mm, 8mm, 3/8" and dovetail.
- Central locking mechanism with NOGA designed spring loaded bearing.
- Powerful on/off magnetic base.
- Instant fixation in any position.
- Fast and easy to set up gauges into required position.
- Black finished arms.

*Fine Adjustment Top

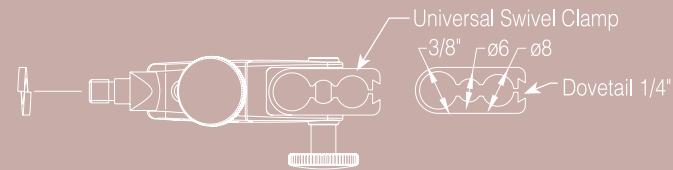
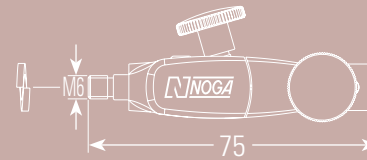
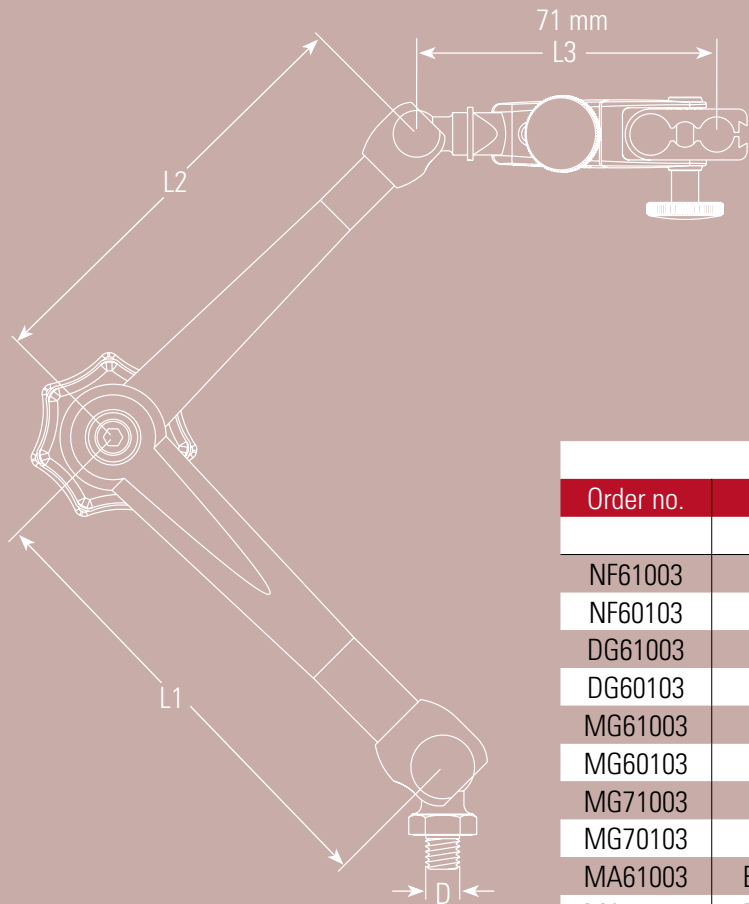

FA1500

FA1510

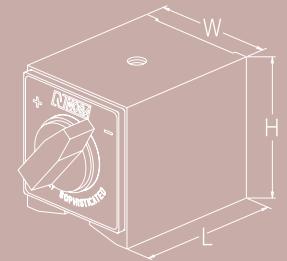

Order no.	Holder		Arm length			Magnet			
	Bottom thread	Weight	Bottom arm	Top arm	Total	Force	Dimension		
	D	[Kg]	L1	L2	L1 + L2 + L3	[N]	W	L	H
NF61003	Ext. M5	0.520	56	51	178	320	30	40	35
NF60103	Ext. M5	0.320	56	51	178	-	-	-	-
DG61003	Ext. M8	1.350	110	101	282	800	50	60	55
DG60103	Ext. M8	0.350	110	101	282	-	-	-	-
MG61003	Ext. M8	1.900	133	113	317	800	50	60	55
MG60103	Ext. M8	0.900	133	113	317	-	-	-	-
MG71003	Ext. M8	1.950	163.5	113	347.50	800	50	60	55
MG70103	Ext. M8	0.950	163.5	113	347.50	-	-	-	-
MA61003	Ext. M10 x 1.25	5.100	286.50	222.5	580	1300	50	120	55
MA60103	Ext. M10 x 1.25	3.100	286.50	222.5	580	-	-	-	-

All measurements are in mm unless otherwise mentioned

Articulated Holder FAB*



NOGA
simply sophisticated

*Fine Adjustment Base



MG10503 / MG10533
Overall arm length 267.5 mm



DG10503 / DG10533
Overall arm length 232.5 mm



NF10403 / NF10433
Overall arm length 128.5 mm

Articulated

Holder FAB*



NOGA articulated holders with fine adjustment at base

NOGA has unique fine adjustment mechanism which is placed on the magnetic base. This mechanism allows the hand to rest on the base rather than on the clamp of the indicator. Zero-setting becomes faster than with any other mechanism.

- Unique single direction fine adjustment at base.
- Powerful on/off magnetic base.
- Holds 8mm or 3/8" and dovetail.
- Central locking mechanism with NOGA designed spring loaded bearing.
- Five axis holder.
- Instant fixation in any position.
- Easy to set up gauges into required position.
- Black finished arms

*Fine Adjustment Base

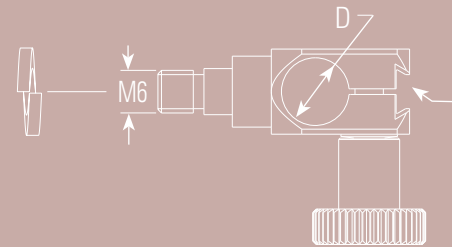
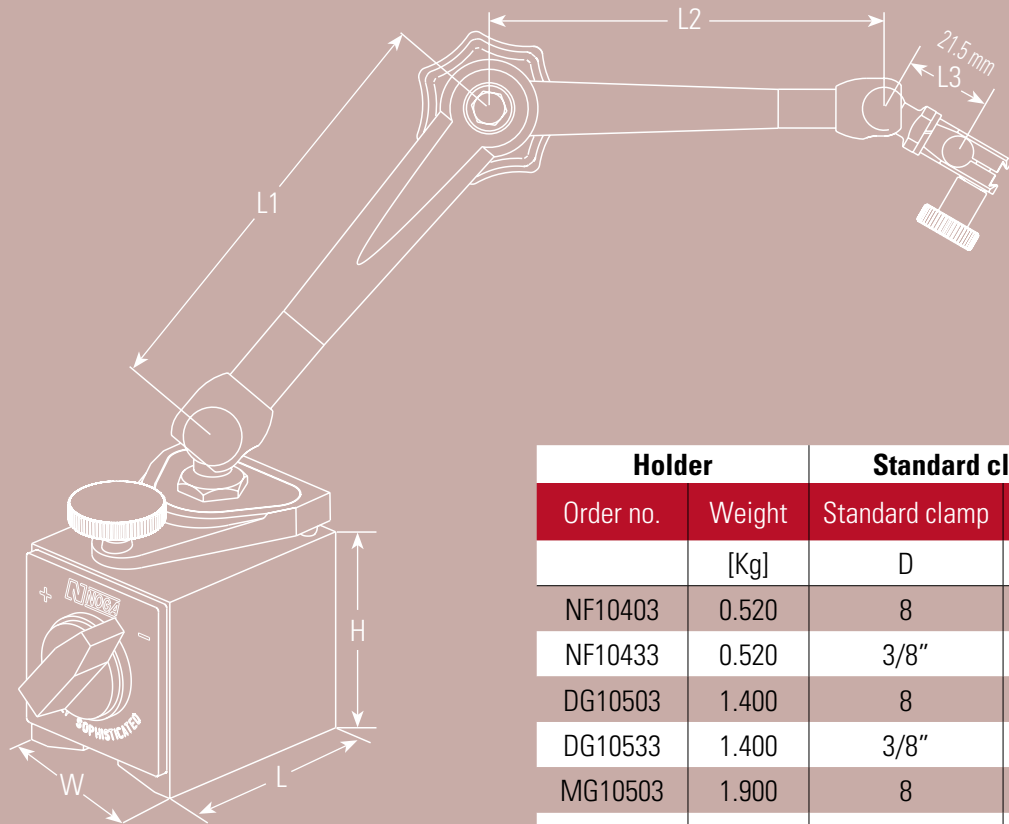

Standard Clamp

FA 1100 dia. 8 mm and FA 1120 dia. 3/8"

Holder		Standard clamp		Arm length			Magnet			
Order no.	Weight	Standard clamp	Order no.	Bottom arm	Top arm	Total	Force	Dimension		
	[Kg]	D		L1	L2	L1 + L2 + L3	[N]	W	L	H
NF10403	0.520	8	FA1100	56	51	128.5	320	30	40	35
NF10433	0.520	3/8"	FA1120	56	51	128.5	320	30	40	35
DG10503	1.400	8	FA1100	110	101	232.5	800	50	60	55
DG10533	1.400	3/8"	FA1120	110	101	232.5	800	50	60	55
MG10503	1.900	8	FA1100	133	113	267.5	800	50	60	55
MG10533	1.900	3/8"	FA1120	133	113	267.5	800	50	60	55

All measurements are in mm unless otherwise mentioned

Articulated Holders FAT & FAB*



NOGA
simply sophisticated

*Fine Adjustment Top & Base



MG6161
Overall arm length 317 mm



DG6160
Overall arm length 282 mm



NF6160
Overall arm length 178 mm

Articulated Holders F&A & F&B*



NOGA articulated holders with double fine adjustment

- New double fine adjustment:
BOTTOM: unique single direction
TOP: universal swivel clamp
- Holds 6 mm, 8 mm, 3/8" and dovetail.
- Unique central locking mechanism with Noga designed spring loaded bearing.
- Five axis holder.
- Powerful ON/OFF magnetic base.
- Instantly fastens in any position.
- Fast and easy to set up gauges into required position.
- Black finished arms.

*Fine Adjustment Top & Base

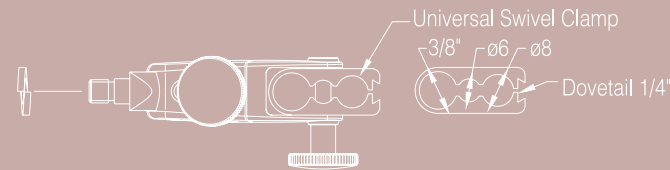
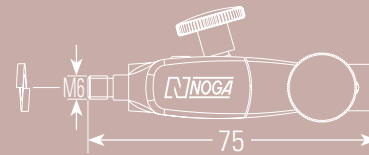
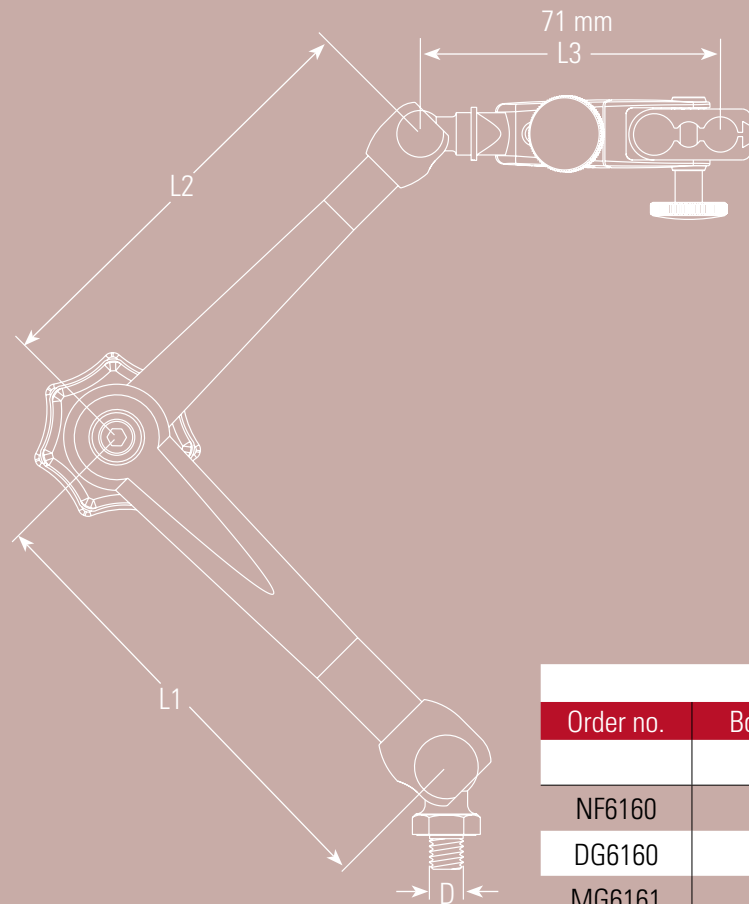

FA1500

FA1510

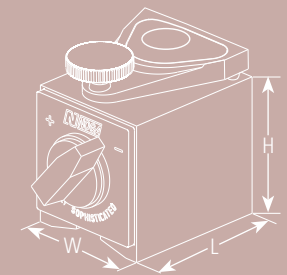

Holder			Arm length			Magnet			
Order no.	Bottom thread	Weight	Bottom arm	Top arm	Total	Force	Dimension		
	D	[Kg]	L1	L2	L1 + L2 + L3	[N]	W	L	H
NF6160	Ext. M5	0.550	56	51	178	320	30	40	35
DG6160	Ext. M8	1.450	110	101	282	800	50	60	55
MG6161	Ext. M8	2.000	133	113	317	800	50	60	55

All measurements are in mm unless otherwise mentioned

Holder Sets and Indicators



**Heavy Duty Holder Set
MG6150**

Includes:
1 pc. articulated holder -
MG61003
1 pc. indicator - DG1000



**Standard Holder Set
DG6150**

Includes:
1 pc. articulated holder -
DG61003
1 pc. indicator - DG1000



**Mini Holder Set
NF6150**

Includes:
1 pc. articulated holder -
NF61003
1 pc. indicator - NF1000

Sets and Indicators

NOGA offers three sets combining the most popular holders with the best made indicators.

DG1000

- Dial diameter 58 mm.
- Stem diameter 8 mm.
- Measuring range 10 mm.
- Graduations 0.01 mm.

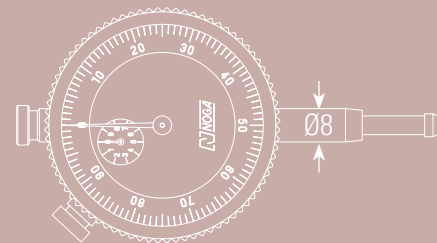
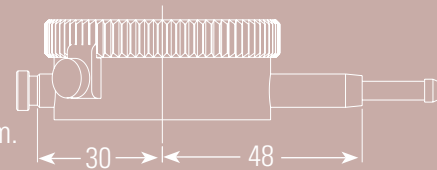

NF1000

- Lever-type test indicator, dial diameter 39 mm.
- Measuring range 0.8 mm.
- Graduations 0.01 mm.
- Contact point 2 mm dia., 20.9 mm length.
- Three dovetails for clamping.

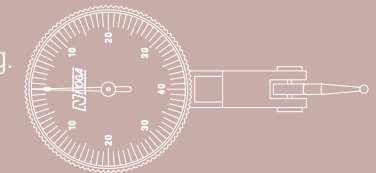
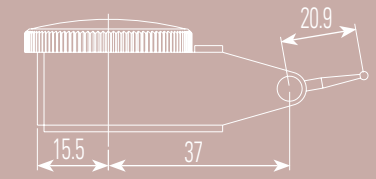

Holder			Arm length			Indicators	Magnet		
Order no.	Bottom thread	Weight	Bottom arm	Top arm	Total	Order no.	Dimension		
	D	[Kg]	L1	L2	L1 + L2 + L3		W	L	H
NF6150	Ext. M5	0.600	56	51	178	NF1000	30	40	35
DG6150	Ext. M8	1.600	110	101	282	DG1000	50	60	55
MG6150	Ext. M8	2.100	133	113	317	DG1000	50	60	55

All measurements are in mm unless otherwise mentioned

Centering Holders



NOGA
simply sophisticated

Centering Holders



DG1022
Overall arm length 282 mm



NF1022
Overall arm length 178 mm



NF1015 / NF1018
Overall arm length 128.5 mm

Centering Holders



NOGA centering holders

- Used for centering workpieces.
- Universal fine adjustment on DG1022 & NF1022.
- Standard clamp on NF1015 & NF1018.
- Unique central locking mechanism with spring loaded bearing.
- Central rod: $\varnothing 8 \times 40$ mm.
- Black finished arms.

Centering Holders

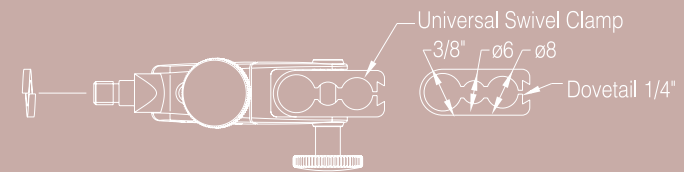
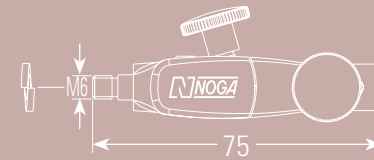
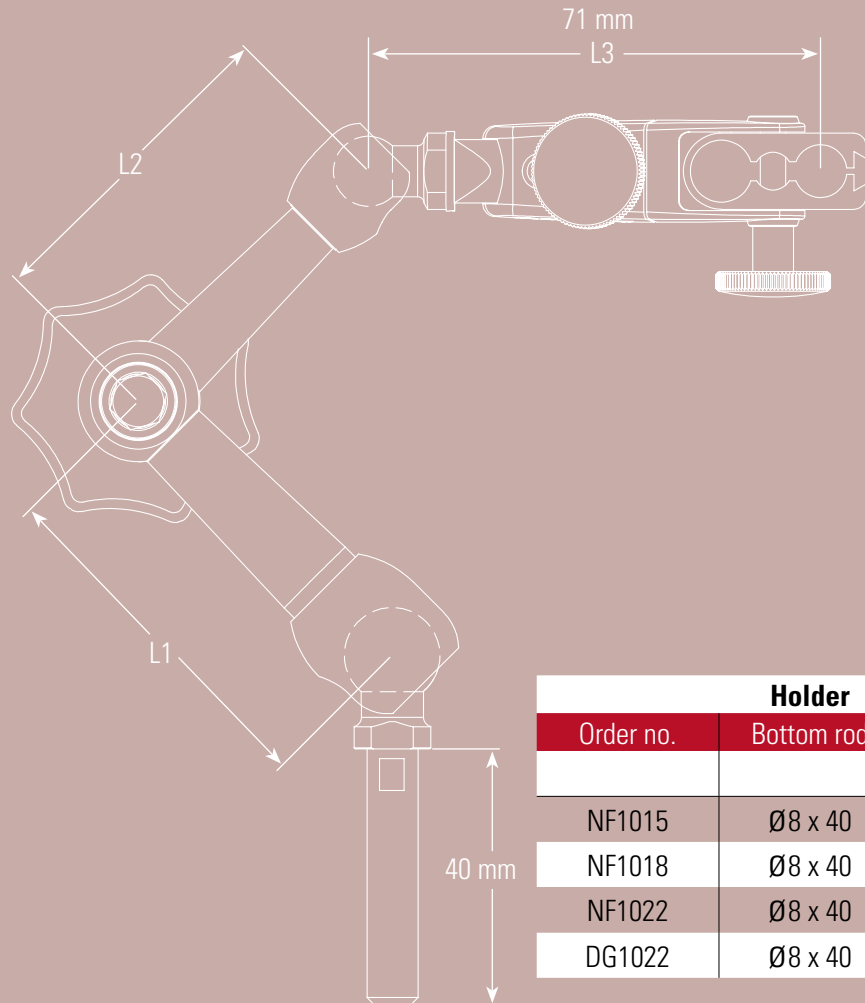

FA1500

FA1510

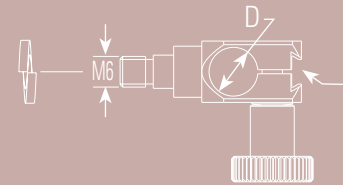

Standard Clamp
FA1100 dia. 8 mm
FA1120 dia. 3/8"

Holder			Arm length			Standard clamp	
Order no.	Bottom rod	Weight [Kg]	Bottom arm	Top arm	Total	Order no.	Dia.
			L1	L2	L1 + L2 + L3		D
NF1015	Ø8 x 40	0.271	56	51	128.5	FA1100	8
NF1018	Ø8 x 40	0.271	56	51	128.5	FA1120	3/8"
NF1022	Ø8 x 40	0.314	56	51	178	FA1500	6, 8, 3/8"
DG1022	Ø8 x 40	0.350	110	101	282	FA1500	6, 8, 3/8"

All measurements are in mm unless otherwise mentioned

Mini Holders

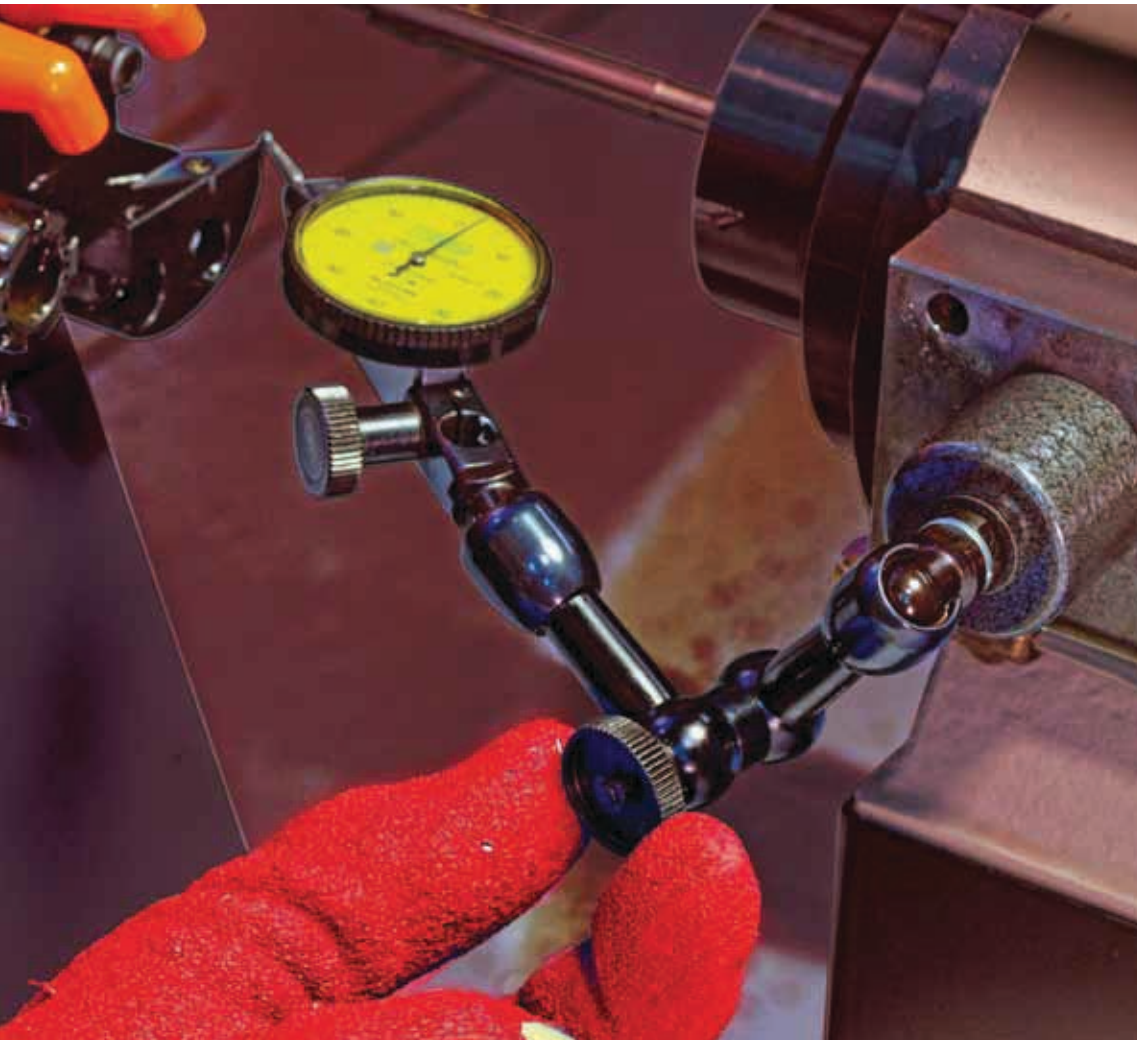

Mini Holders



PH5000

LC6200 8 mm
LC6210 3/8"

Overall arm length 87.5 mm

NF1030 8 mm
NF1033 3/8"

Overall arm length 128.5 mm

NF1021 8 mm
NF1024 3/8"

Overall arm length 128.5 mm

LC and PH Mini Holders

NOGA LC mini holder with small round magnet

LC6200 / LC6210

- 200 N round permanent magnetic base.
- Holds 8 mm or 3/8" and dovetail.
- Unique central locking mechanism with Noga designed spring loaded bearing.
- Five axis holder.
- Instantly and easily fastens in any position.
- Black finished arms.

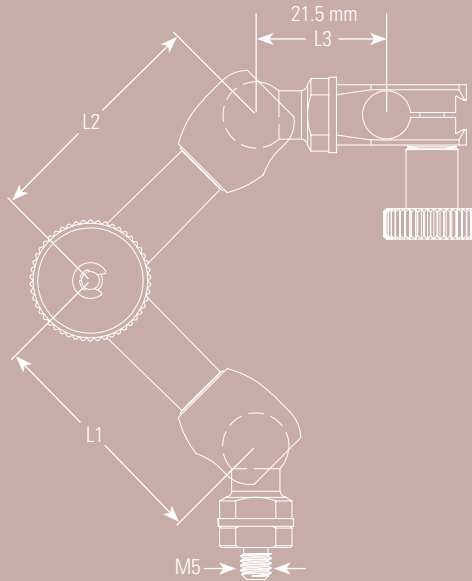

NOGA PH mini holder with small round magnet PH5000

- 200 N round permanent magnetic base.
- Holds 6 mm, 8 mm, 3/8" and dovetail.
- Unique swivel clamp for all dial and test indicators.
- Strong arm lock by using the unique 3-point system.
- Easy set up of gauges into required position.
- Black finished arms.

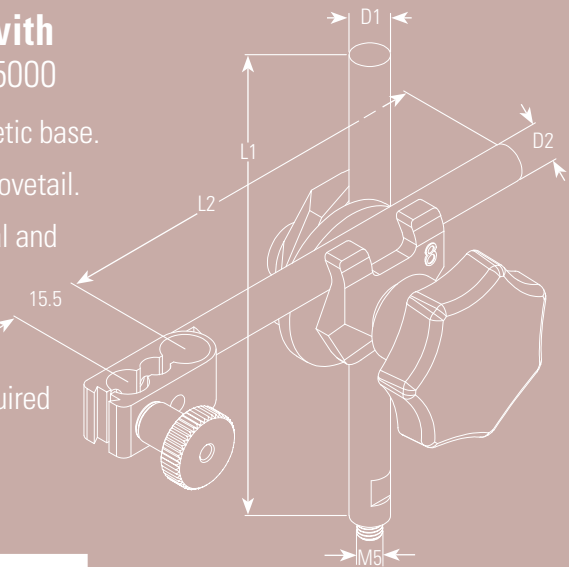

Holder		Arm length			Standard clamp		Magnet		
Order no.	Weight	Bottom arm	Top arm	Total	Order no.	Dia.	Force	Dimension	
	[Kg]	L1	L2	L1 + L2 + L3		D	[N]	Ø	H
LC6200	0.280	38	38	87.5	FA1100	8	200	30	25
LC6210	0.280	38	38	87.5	FA1120	3/8"	200	30	25

Holder		Arm length and diameter		Magnet		3 points clamp	
Order no.	Weight	Post	Arm	Force	Dimension		Order no.
	[Kg]	Dia. (D1) x length (L1)	Dia. (D2) x length (L2)	[N]	Ø	H	
PH5000	0.360	Ø8 x 110	Ø8 x 110	200	30	25	PH1307

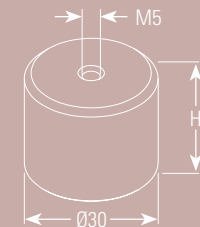

NogaFlex Mini Holders 360°

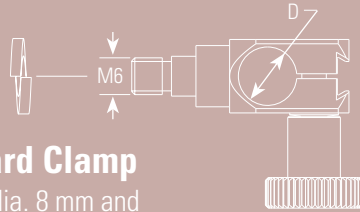

Standard Clamp

FA 1100 dia. 8 mm and
FA 1120 dia. 3/8"

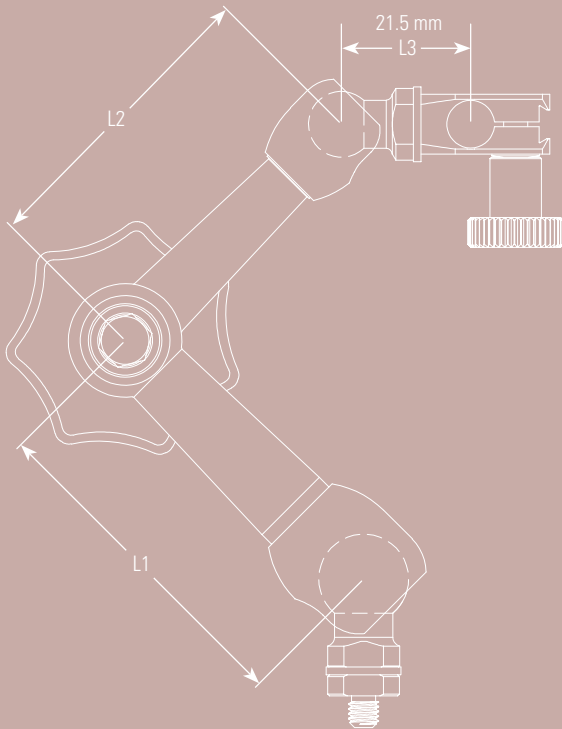

NogaFlex holder with on / off magnet NF1021 / NF1024

- Powerful on/off magnetic base.
- Five axis holder.
- Holds indicator with stem and dovetail.
- Instant fixation in any position.
- Central locking mechanism with NOGA designed spring loaded bearing.
- Black finished arms.

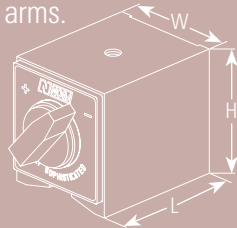

NogaFlex holder with permanent magnet NF1030 / NF1033

- Permanent magnetic base.
- Five axis holder.
- Holds indicator with stem and dovetail.
- Instant fixation in any position.
- Central locking mechanism with NOGA designed spring loaded bearing.
- Black finished arms.

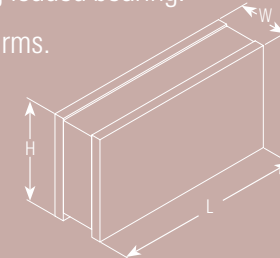
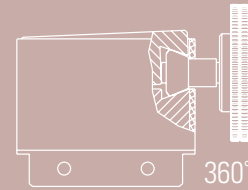

Holder		Arm length			Standard clamp		Magnet			
Order no.	Weight	Bottom arm	Top arm	Total	Order no.	Dia.	Force	Dimension		
	[Kg]	L1	L2	L1 + L2 + L3		D		W	L	H
NF1021	0.575	56	51	128.5	FA1100	8	320N	30	40	35
NF1024	0.575	56	51	128.5	FA1120	3/8"	320N	30	40	35
NF1030	0.545	56	51	128.5	FA1100	8	280N	16	60	32
NF1033	0.545	56	51	128.5	FA1120	3/8"	280N	16	60	32

All measurements are in mm unless otherwise mentioned

Special Articulated Holders Top



DG1044
Overall arm length 282 mm



DG1030 / DG1033
Overall arm length 261 mm



MG1030 / MG1033
Overall arm length 317 mm

Special Articulated Holders

DG/MG Holders

Unique DG & MG arms with plastic fine adjustment. Ideal for EDM.

DG1044

Special DG arm with vacuum base. Ideal for granite table.

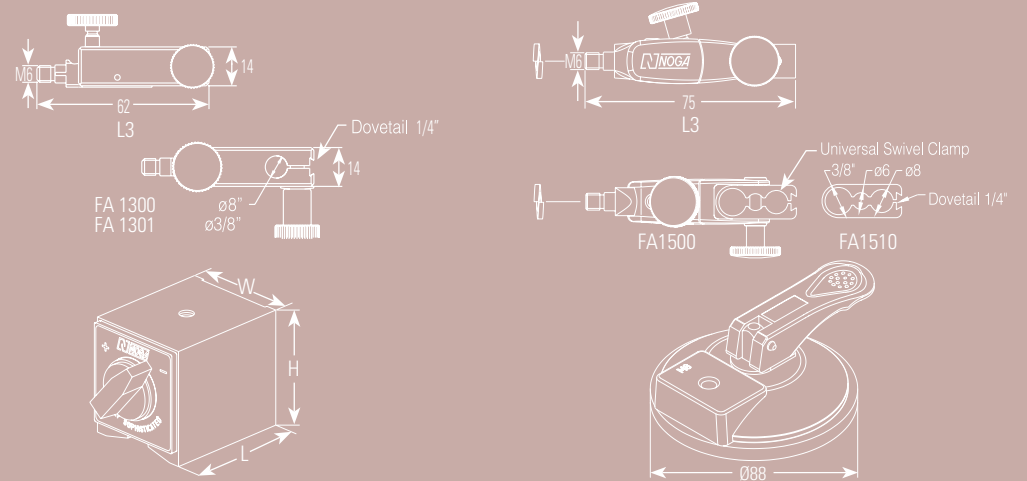
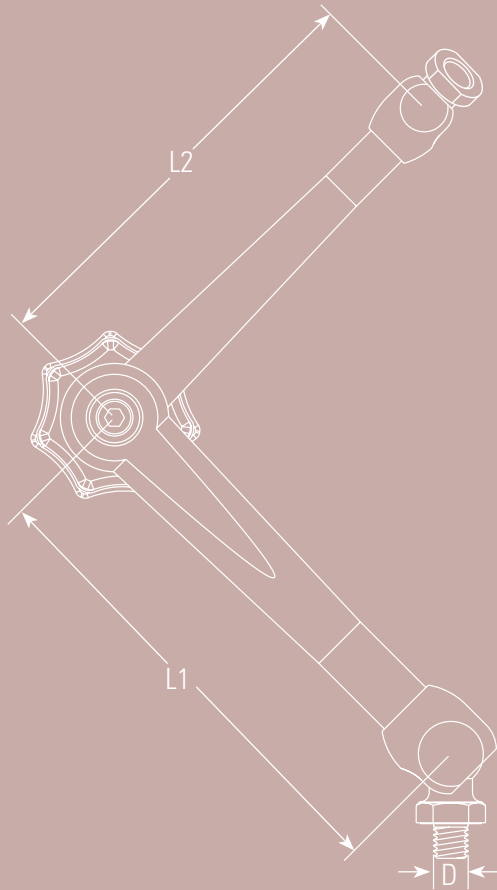

Holder			Arm length			Magnet			Standard Clamp		
Order no.	Bottom thread	Weight	Bottom arm	Top arm	Total	Force	Dimension			Order no.	D
	D	[Kg]	L1	L2	L1 + L2 + L3	[N]	W	L	H		
DG1030	Ext. M8	1.350	110	101	261	800	50	60	55	FA1300	8mm
DG1010	Ext. M8	0.350	110	101	261	-	-	-	-	FA1300	8mm
DG1033	Ext. M8	1.350	110	101	261	800	50	60	55	FA1301	3/8"
DG1013	Ext. M8	0.350	110	101	261	-	-	-	-	FA1301	3/8"
DG1044	Ext. M8	0.740	110	101	282	350	-	ø88	-	FA1500	6mm, 8mm, 3/8"
MG1030	Ext. M8	1.850	133	113	317	800	50	60	55	FA1300	8mm
MG1010	Ext. M8	0.850	133	113	317	-	-	-	-	FA1300	8mm
MG1033	Ext. M8	1.850	133	113	317	800	50	60	55	FA1301	3/8"
MG1013	Ext. M8	0.850	133	113	317	-	-	-	-	FA1301	3/8"

All measurements are in mm unless otherwise mentioned

Post Holders F&T*



*Fine Adjustment Top



PH6800



PH6600



PH6400

Post Holders FAT*

NOGA economical holders with fine adjustment on top

NOGA PH (Post Holder) holders are the latest improvement of the traditional indicator holder.

- Fine adjustment on the top with universal swivel clamp.
- Holds 6mm, 8mm, 3/8" and dovetail.
- Powerful on/off magnetic base.
- Strong arm lock by using 3 points clamp.
- Easy to set up gauges into required position.
- Black finished arms.



*Fine Adjustment Top

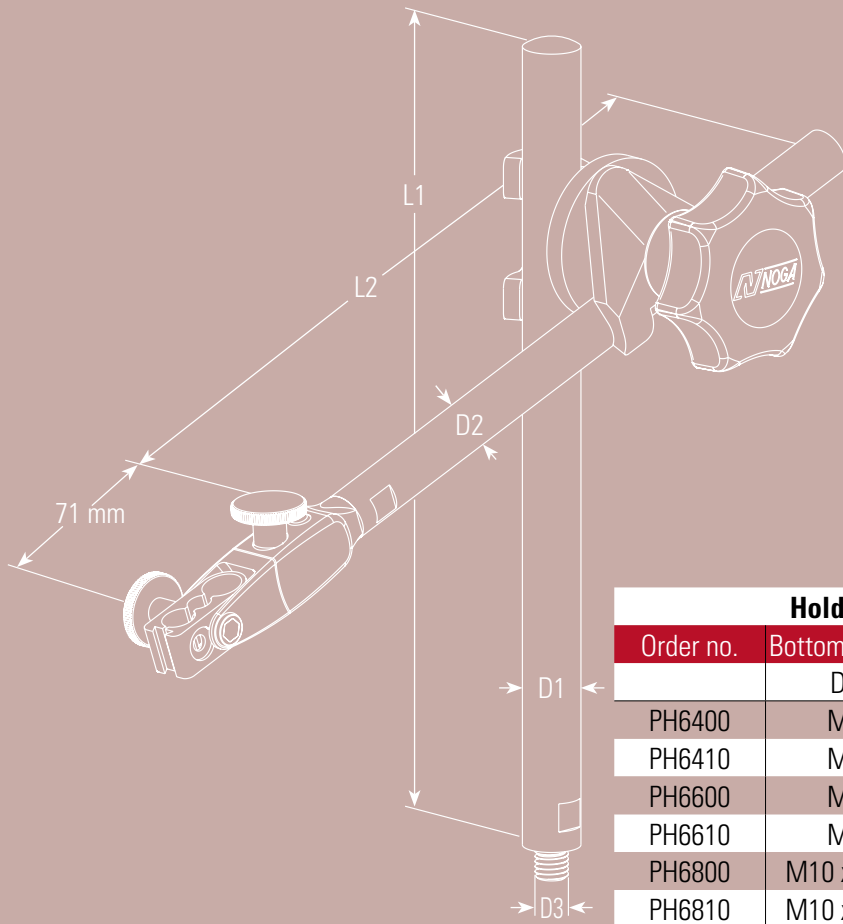

3 points clamp

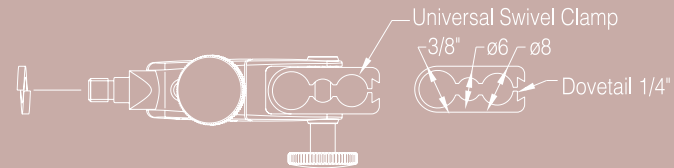
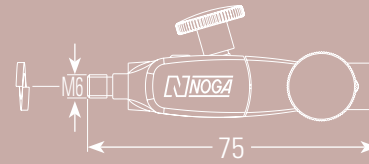

FA1500

FA1510

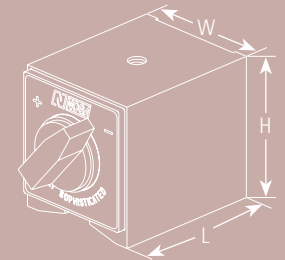

Holder			Arm length and diameter		Magnet			3 points clamp	
Order no.	Bottom thread	Weight	Post	Arm	Force	Dimension			Order no.
	D3	[Kg]	Dia. (D1) x length (L1)	Dia. (D2) x length (L2)	[N]	W	L	H	
PH6400	M8	1.700	Ø14 x 203	Ø12 x 185	800	50	60	55	PH0310
PH6410	M8	0.700	Ø14 x 203	Ø12 x 185	-	-	-	-	PH0310
PH6600	M8	2.300	Ø16 x 260	Ø16 x 225	1000	50	75	55	PH0312
PH6610	M8	1.070	Ø16 x 260	Ø16 x 225	-	-	-	-	PH0312
PH6800	M10 x 1.25	3.450	Ø18 x 350	Ø16 x 225	1300	50	120	55	PH0313
PH6810	M10 x 1.25	1.450	Ø18 x 350	Ø16 x 225	-	-	-	-	PH0313

All measurements are in mm unless otherwise mentioned

PH Holders FAB*



NOGA
simply sophisticated

*Fine Adjustment Base



PH4016



PH2040



PH3100

Post Holder

FAB*

NOGA economical holders with fine adjustment at base

PH holders with NOGA unique fine adjustment at base.

- Single direction fine adjustment at base.
- Powerful on/off magnetic base.
- Universal swivel clamp for all dial and test indicators.
- Holds 6mm, 8mm, 3/8" and dovetail.
- Strong arm lock by using 3 points clamp.
- Easy to set up gauges into required position.
- Black finished arms.



*Fine Adjustment Base

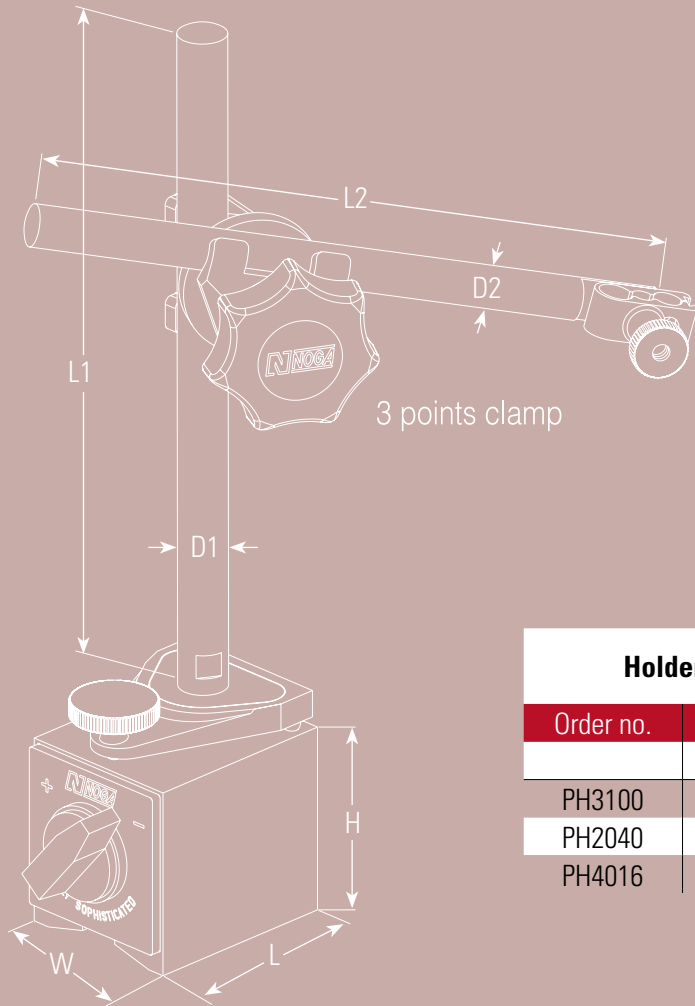

Universal swivel clamp



Holder		Arm length and diameter		Magnet			3 points clamp	Universal swivel clamp	
Order no.	Weight	Post	Arm	Force	Dimension			Order no.	Order no.
	[Kg]	Dia. (D1) x length (L1)	Dia. (D2) x length (L2)	[N]	W	L	H		
PH3100	0.500	Ø10 x 120	Ø8 x 110	320	30	40	35	PH0315	FA1210
PH2040	1.700	Ø14 x 203	Ø12 x 185	800	50	60	55	PH0310	FA1410
PH4016	2.450	Ø16 x 260	Ø16 x 225	1000	50	75	55	PH0312	FA1410

All measurements are in mm unless otherwise mentioned

Modular Holders



6 NOGA Modular holders

- Six different sizes of articulated arms are offered for a wide range of applications.
- Choose the arms that fit your needs.
- A range of accessories are shown on pages 107 - 110.
- Custom-made arms and accessories are available upon request.
- Minimum quantity 500 pcs.

MA60003

Overall arm length 509 mm

MG70003

Overall arm length 276 mm

MG60003

Overall arm length 246 mm

DG60003

Overall arm length 211 mm

NF60003

Overall arm length 107 mm

LC6100

Overall arm length 76 mm

**THE
SMALLEST AND
LIGHTEST ARM IN
THE MARKET**

NOGA
simply sophisticated

Modular Holders

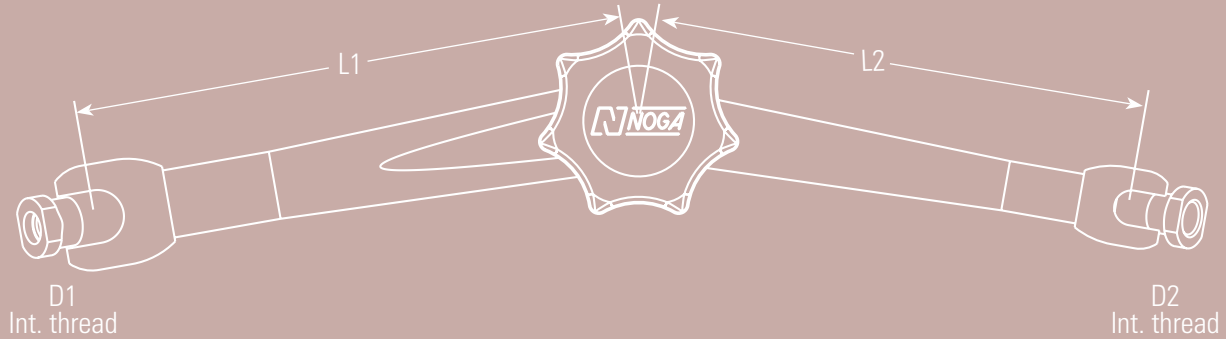

Order no.	Weight [Kg]	Int. thread		Arms length		
		D1	D2	L1	L2	Total L1 + L2
LC6100	0.121	M6	M6	38	38	76
NF60003	0.210	M6	M6	56	51	107
DG60003	0.250	M6	M6	110	101	211
MG60003	0.750	M8	M6	133	113	246
MG70003	0.800	M8	M6	163	113	276
MA60003	3.000	M10 x 1.25	M6	286.5	222.5	509

All measurements are in mm unless otherwise mentioned

NOGA Bases



DG0039



DG0038



DG0036



NF0037



HS1100



DG0040



DG1003



DG0118



DG3678



NF3778

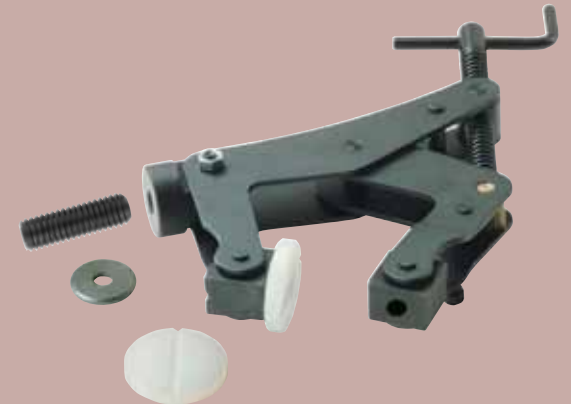

Noga Bases

NOGA bases

Different magnets ranging from the world's smallest switchable on/off (320 N) to a large magnetic base (1300 N). A 350 N vacuum base and 5 clamps are offered for our customers' choice.

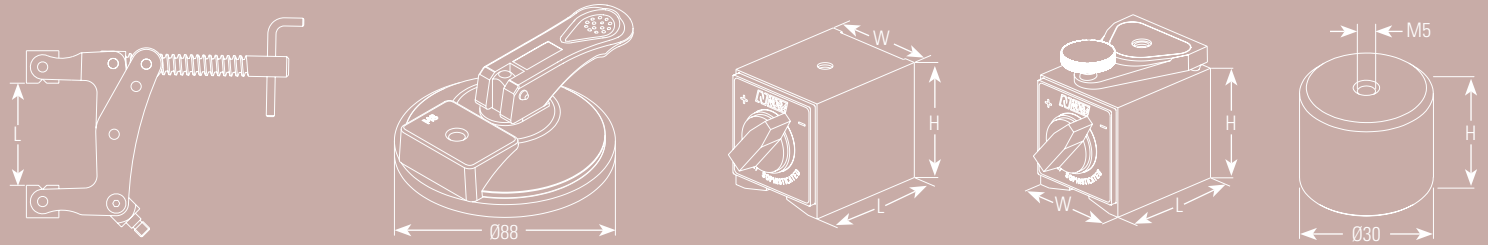





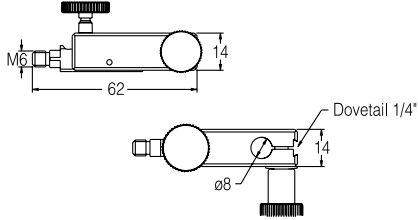

Order no.	Type	Weight [Kg]	Force [N]	Thread	W	L	H
HS1100	Round magnet	0.123	200	M5	-	Ø30	25
NF0037	On/off magnet	0.230	320	M5	30	40	35
NF3778	On/off magnet with fine adj.	0.250	320	M5	30	40	35
DG0036	On/off magnet	1.000	800	M8	50	60	55
DG3678	On/off magnet with fine adj.	1.100	800	M8	50	60	55
DG0038	On/off magnet	1.270	1000	M8	50	75	55
DG0118	On/off magnet with fine adj.	1.380	1000	M8	50	75	55
DG0039	On/off magnet	2.000	1300	M10 x 1.25	50	120	55
DG1003	On/off magnet with multi threads	1.350	1000	M6/8/10/12 10 x 1.25	50	75	55
DG0040	Vacuum base	0.400	350	M8	-	Ø88	23
MA0322	4" clamp	1.150	-	Ext. M10 x 1.25	-	100	-
MA0320	4" clamp	1.160	-	Int. M10 x 1.25	-	100	-
MG1006	3" clamp	0.570	-	Ext. M8	-	75	-
MG1003	3" clamp	0.600	-	Int. M8	-	75	-
MG0125	3" clamp with plastic cover	0.600	-	Int. M8	-	75	-

All measurements are in mm unless otherwise mentioned

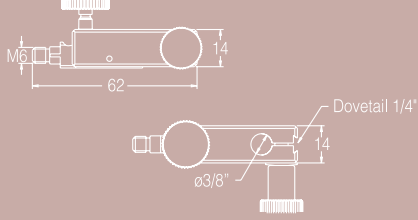
Top Attachments

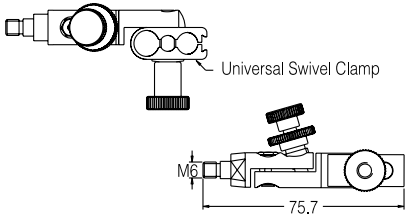
For dial & test indicators

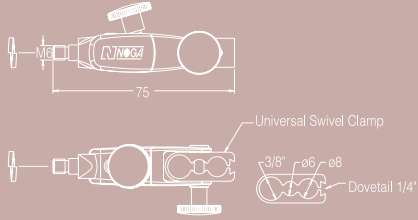
<p>FA1300</p>	<p>M6</p>	<p>Plastic F.A. 8 mm</p>		
<p>FA1301</p>	<p>M6</p>	<p>Plastic F.A. 3/8"</p>		
<p>FA1400</p>	<p>M6</p>	<p>2SM Metal F.A. 6 mm, 8 mm, 3/8"</p>		
<p>FA1500</p>	<p>M6</p>	<p>Metal F.A. 6 mm, 8 mm, 3/8"</p>		

Top Attachments

Quick Release AD4000

Enables a quick change to the equipment without having to fiddle with screws and threads.

Simply pull back the red sleeve and slot in the Noga arm into the Quick Release attachment.

Quick Release can be held by a range of Noga arms.

Features bottom external thread M6 and top external thread 1/4" UNC.



Clamps for top attachment

NF0125	M6 EXT.	Clamp 1"		
DG0125	M6 EXT.	Clamp 2"		

45 mm Clamp CS4550









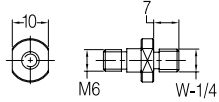

The strong CS4550 clamp with its special soft grip expands onto round and flat surfaces up to 45 mm.

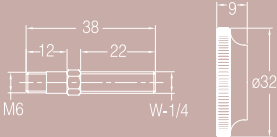
Features internal threads: 2 x 1/4", 2 x 3/8", 1 x 6 mm, 1 x 8 mm.

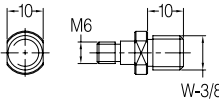

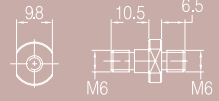

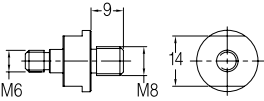

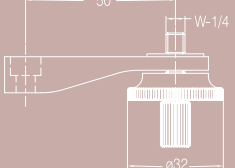

Accessories

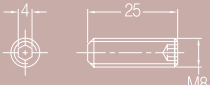
M6 Adaptors

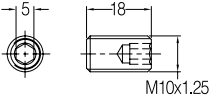
AD6010		
AD6015		
AD6030		
AD6060		
AD6080		
MA0125		

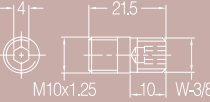
M8 Adaptors

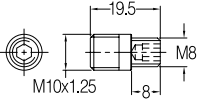
AD8030		
AD8080		
M10 x 1.25 Adaptors		
AD1000		
AD1030		
AD1080		

Accessories



3 Point Clamp

	Dia. Post	Dia. Arm	
PH1307	8	8	For Holder PH5000
PH0315	10	8	For Holder PH3100
PH0310	14	12	For Holders: PH2040 PH6400 PH6410 
PH0312	16	16	For Holders: PH4016, PH6600, PH6610
PH0313	18	16	For Holders: PH6800, PH6810

Knobs

DG0160	Knob for NF & DG Holders	
MG1620	Knob for MG Holders	
MA0100	Knob for MA Holders	

Screws

DG0340	M5 x 9	Replacement screw for FA1500. 
DG0141	M4 x 12	Replacement screw for DG10503, DG10533, MG10503, MG10533, NF 10403, NF 10433, DG6160 & MG6161. 



NOGA
simply sophisticated

Main Content

DEBURRING SYSTEMS

1-65

HOLDING SYSTEMS

66-111

COOLING SYSTEMS
CUTTING FLUID APPLICATORS

112-124

INDEX

125-126

Cooling Systems CUTTING FLUID APPLICATORS



NOGA
simply sophisticated

Contents

NOGA Cutting Fluid Applicators were designed to answer various needs for cooling during machining, turning, drilling tapping etc. They are made in four different designs:

MINICOOL

MINICOOL have air and liquid mixture forms a fine spray that cools all metal cutting operations.

115-116

FIXED & VARI HP (HIGH PRESSURE) COOL

The Fixed HP Cool Arm and Vari HP Cool arms deliver fluids or cooling liquids at high pressure, up to 1000 PSI, allowing a higher level of machining. Easy and fast to set in position. Can be fitted with different sizes of nozzles.

117-118

NOGACOOOL

The NOGACOOOL consists of a manifold and flexible Loc-Line® hose held by a magnet. It is used to easily direct cutting fluid from the coolant pump of machine tools towards the cutting area.

119-120

COBRA

The COBRA drop-ejector shoots small quantities of liquid towards a distinct target. Various options enable the user to apply either single drops, or spray burst, or an air stream with small amounts of liquid.

121-125

MiniCool



NOGA MINICOOL uses the VENTURI principle to spray an air and liquid mixture. It consists of the following basic parts:

A control valve, spray unit, air line, syphon line and a powerful on/off Popeye magnet, which has a "V" form base, making it possible to mount on non-flat surfaces.

The MINICOOL enables the user to easily control both the air flow rate and liquid rate.

Stainless steel armoured syphon hose and air hose are made in a standard one meter length (special lengths available upon request).

The spray unit comes in three standard lengths: 264, 334, 479 mm (special lengths available upon request).

MiniCool

MiniCool MC1700

For Maximum heat dissipation and extended tool life

- Strong magnetic base
- Separate on/off air and fluid controls
- Stainless steel armoured syphon hose and air hose
- Nozzle connected via Loc-Line® flexible hose
- Simple, inexpensive, rugged
- Single spray unit

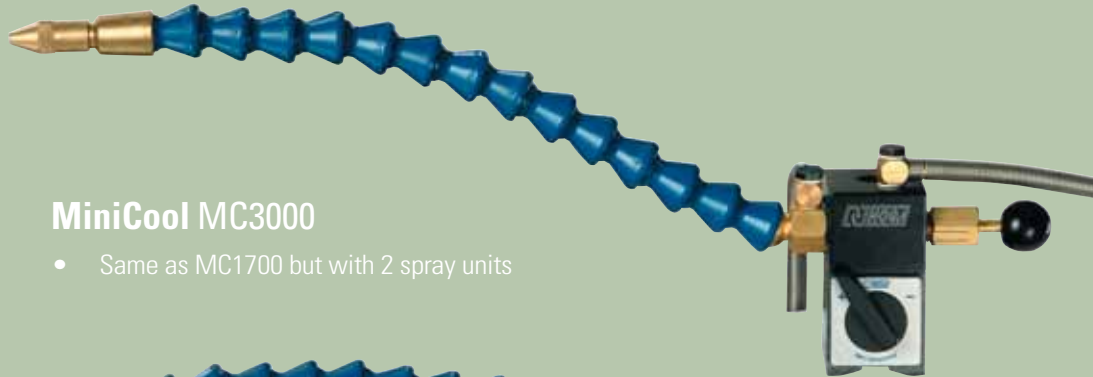

MiniCool MC3000

- Same as MC1700 but with 2 spray units

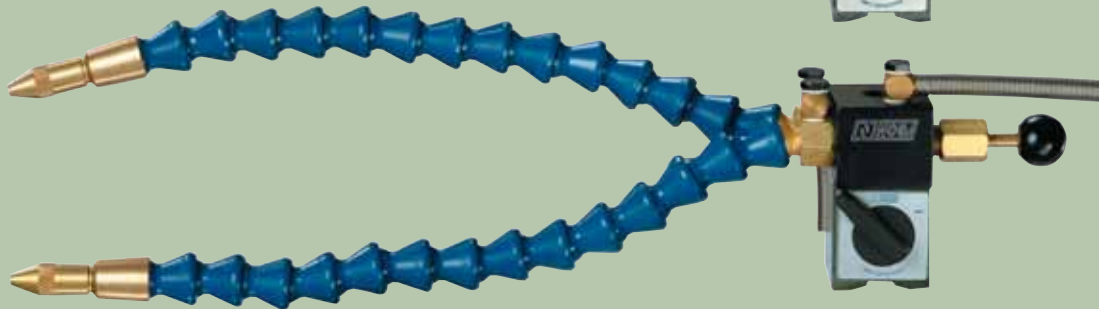







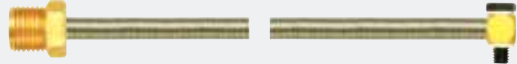

order no.

One spray unit of length (mm)			Two spray units of length (mm)			Air hose	Syphon hose
264	334	479	264	334	479		
MC1700	MC1800	MC2000	MC3000	MC3100	MC3200	1 M	1 M
MC1730	MC1830	MC2030	MC3030	MC3130	MC3230	2 M	2 M

SPARE PARTS

order no.

MC0130		control valve with popeye magnet
MC0101 MC0102 MC0103		spray unit 270 mm spray unit 340 mm spray unit 485 mm
MC0380 MC0302		air line 1 m air line 2 m
MC0360 MC0311		suction line 1 m suction line 2 m
MC0204		valve stem
MC3637		filter
MC0001		nozzle nut
MC0232		banjo screw & washer
MC0031		banjo fitting

Fixed & Vari HP Cool Arms



NOGA is introducing its patent pending newest product to the Cooling Systems line.

The Fixed HP Cool Arm and Vari HP Cool arms deliver fluids or cooling liquids at high pressure, up to 1000 PSI, allowing a higher level of machining.
Easy and fast to set in position.
Can be fitted with different sizes of nozzles.

**PATENT
PENDING**

Fixed & Vari HP Cool Arms

SPARE PARTS for CA2000 and CA3000

HEX KEY CA1010
Hex. 5 mm



NOZZLE CA1002
Dia. 2 mm



NOZZLE CA1004
Dia. 4 mm - Standard



NOZZLE CA1006
Dia. 6 mm



ADAPTOR AD1001
Ext. NPT 1/4" - Ext. NPT 1/4"



more adaptors are available upon request.

FIXED HP COOL ARM CA2000

Single arm with 2 end ball joints so the nozzles can move on wide curve for positioning.



Dimensions:
Length: 164 mm
Thread: Int. NPT 1/4"

VARI HP COOL ARM CA3000

Long articulated arms provide full axis rotation. Sturdy tightening fixtures for total stability.



Dimensions:
Length: 206 mm
Thread: Int. NPT 1/4"

Both CA2000 and CA3000 are provided with:
CA1010 Hex Key
CA1004 Nozzle
AD1001 Adaptor

MINI VARI HP COOL ARM CA3500

Same as CA3000 but with shortened articulated arms.



Dimensions:
Length: 84 mm
Thread: Int. NPT 1/4"

The CA3500 is provided with:
CA1010 Hex Key
CA1007 Nozzle
CA1008 Adaptor

SPARE PARTS for CA3500

HEX KEY CA1010
Hex. 5 mm



NOZZLE CA1007
Dia. 3 mm



ADAPTOR CA1008
Ext. M6 - Ext. NPT 1/4"



NogaCool



NOGACOOL consists of a manifold & Loc-Line® flexible hose with a nozzle on top and a valve at the bottom, assembled on the powerful on/off Popeye magnet.

The plug attached can be replaced by a second Loc-Line® flexible hose.

NOGACOOL is supplied with a set of three nozzles: 1/16", 1/8" and 1/4".

Working conditions are as follows:

- Pressure: 2-3.4 Bar (30-50 Psi)
- Flow rate: 940 l/hour (250 gal/hour)
- Max. working temp. 170°C

Also available with magnet and manifold only (order no. MC0161).

NogaCool

NOGACOOL MC1601

SPARE PARTS

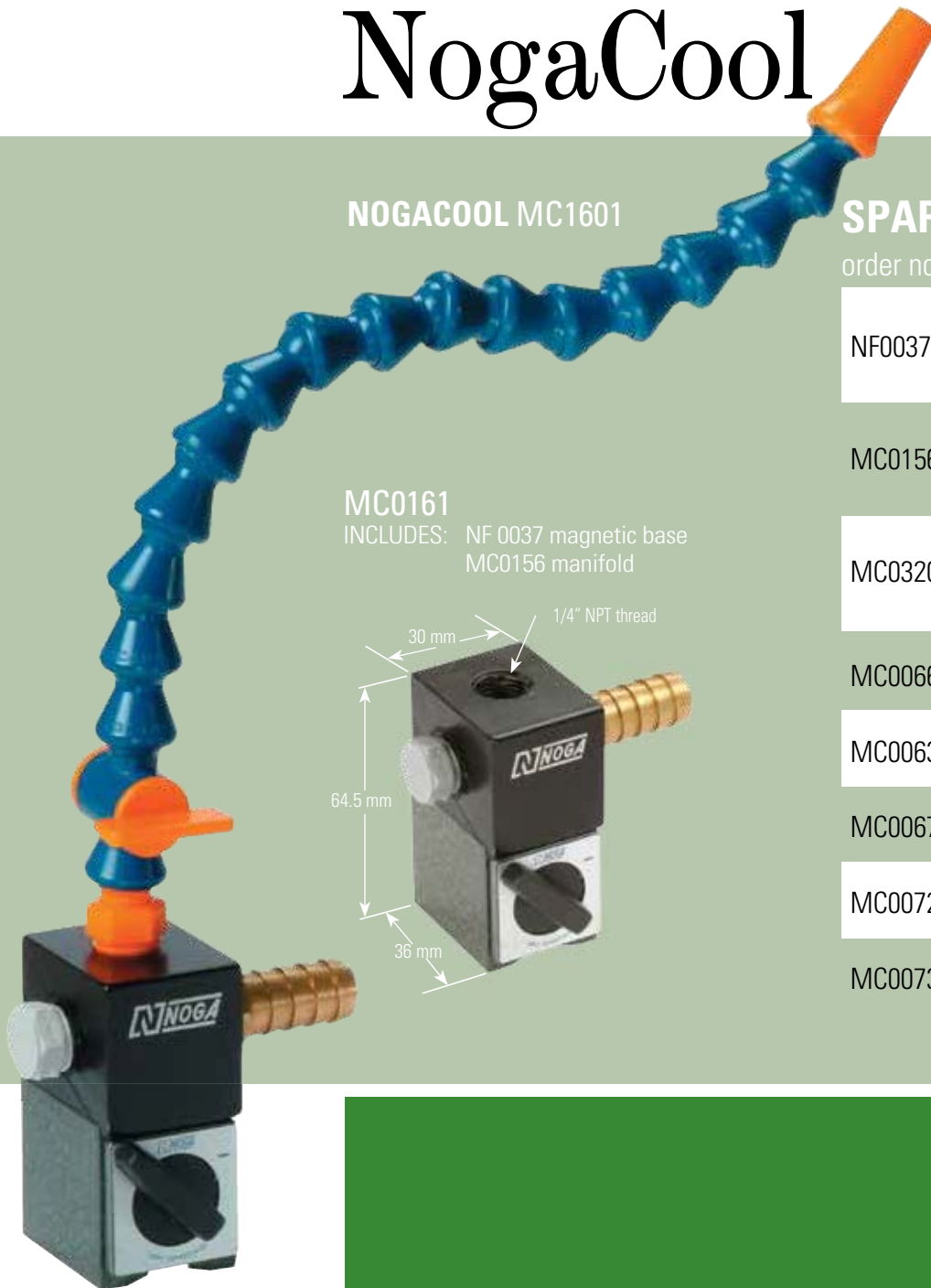









MC0161

INCLUDES: NF 0037 magnetic base
MC0156 manifold



order no.

NF0037		320N popeye magnet top thread M5
MC0156		manifold
MC0320		324 mm flexible Loc-Line® hose Other dimensions available upon request.
MC0066		Ø1.6 mm plastic nozzle (1/16")
MC0063		Ø3.2 mm plastic nozzle (1/8")
MC0067		Ø6.3 mm plastic nozzle (1/4")
MC0072		Wide plastic nozzle 16 holes Ø1 mm
MC0073		Wide plastic nozzle 16 holes Ø1.5 mm

Cobra



COBRA's drop ejector is designed to accurately shoot small quantities of liquid to distinct targets. An air actuated piston shoots the drops through a flexible hose onto the target.

The drop shots can be automatically timed or manually determined by the user, the amount of liquid in each shot can also be adjusted by a tuning screw at the back of the COBRA all according to the user's needs.

The COBRA is operated by clean air, pressure 3-9 bar. Most liquids and solvents up to 250 cst viscosity can be applied.

Cobra



COBRA CB2000

INCLUDES:
Basic Cobra only



COBRA SET CB2100

INCLUDES:
Basic Cobra CB2000
Small container CB0146
Mechanical valve SH1000
Magnet DG0036
Arm DG60013
Adaptor DG0129
Nylon tube RM8050

See drawing on page 123

SPARE PARTS

order no.

MC0001		nuzzle nut
MC0232		banjo screw & washer
MC0031		banjo fitting
MC0030		washer

Cobra

Set-up and Accessories

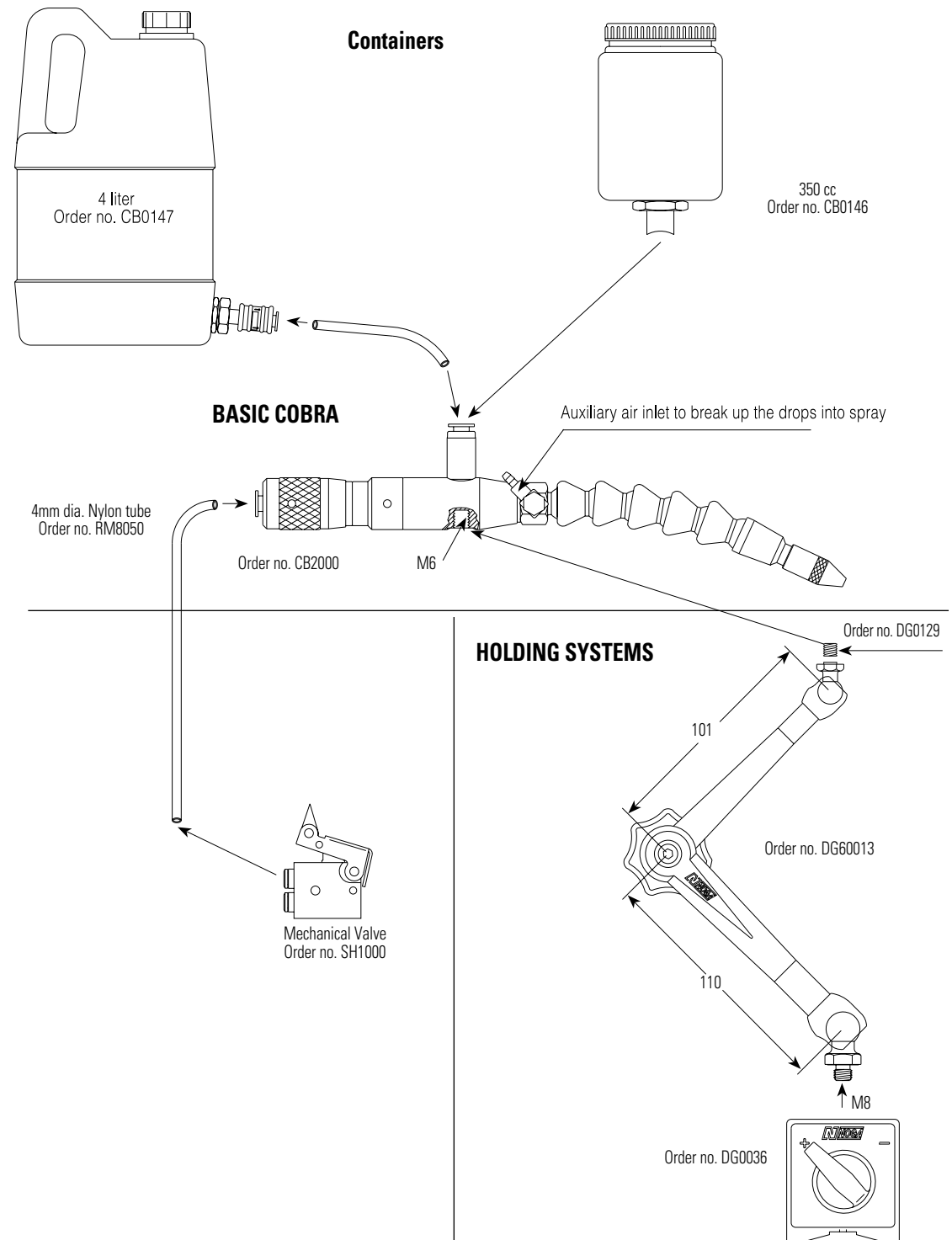

Operating Instructions

The fluid can be supplied either by fitting the bowl (CB0146) directly onto the unit or by using the large container (CB0147) and connecting it to the unit by 4 mm hose. Set up the pneumatic circuit as shown in one of the drawings (a) or (b) or (c). All connections are to be made with 4 mm hose.

Open drop size control nut "S" to maximum drop size. Start pulsing the unit by pressing the actuating valve many times until drops emerge.

Adjust the drop size to your needs. If you have set up the circuit according to drawing (b), or (c), adjust the air flow with the nozzle nut "T".

- a. Setup for single drops using mechanical valve.

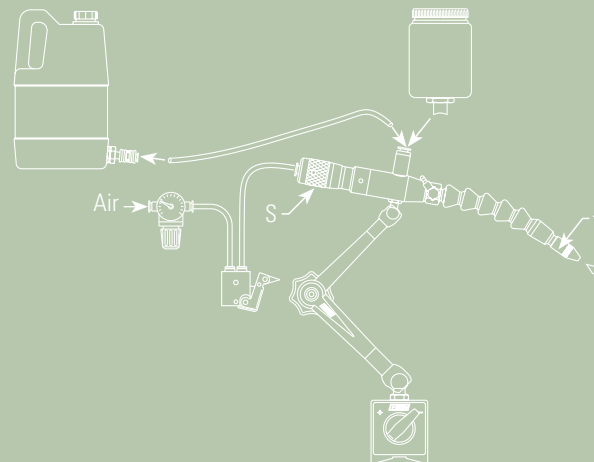

- b. Setup for finely dispersed droplets.

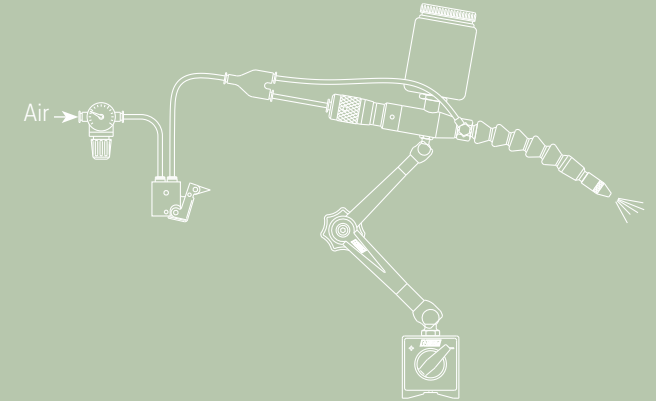

- c. Setup to supply drops and air jet independently.

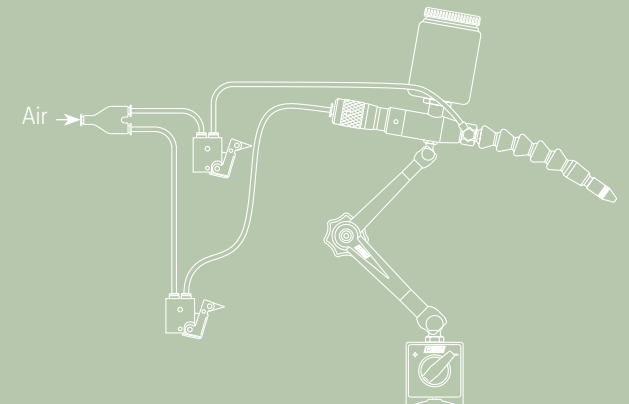

Index

Order No.	Page	Order No.	Page	Order No.	Page	Order No.	Page	Order No.	Page	Order No.	Page
AD1000	109	BK1012	55	BS1011	55	CA3500	118	DG0118	106	EL07013	36
AD1001	118	BK2010	6	BS1012	6	CB0146	123	DG0125	108	EL0802	18
AD1030	109	BK3010	6	BS1013	55	CB0147	123	DG0129	123	EL0902	18
AD1080	109	BK3112	6	BS1014	55	CB2000	122	DG0141	110	EO1000	4
AD4000	108	BL1001	38	BS1016	55	CB2100	122	DG0160	110	EO2000	4
AD6010	109	BL3001	36	BS1018	6	CH1950	26	DG0340	110	EO2100	8
AD6015	109	BL4001	36	BS1019	55	CH1970	26	DG1000	84	EX2001	22
AD6030	109	BL5001	38	BS1510	55	CH3000	18	DG1003	106	EX3001	18
AD6060	109	BL6001	38	BS2010	6	CH3300	22	DG1010	94	FA1100	78
AD6080	109	BL7001	38	BS2012	6	CR1100	40	DG1013	94	FA1120	78
AD8030	109	BN1010	12	BS2015	55	CR1400	42	DG1022	88	FA1210	102
AD8080	109	BN1012	12	BS3003	55	CR1500	40	DG1030	94	FA1300	107
BC1001	38	BN1026	56	BS3010	6	CR1550	42	DG1033	94	FA1301	107
BC1041	22	BN1027	56	BS3510	6	CR2000	40	DG1044	94	FA1400	107
BC1044	22	BN1028	56	BS6001	6	CR2100	42	DG10503	78	FA1410	102
BC1211	18	BN1029	56	BS6003	55	CR2200	42	DG10533	78	FA1500	107
BC1651	22	BN1310	12	BS7001	6	CR2300	40	DG3678	106	FA1510	74
BC2011	18	BN2010	12	BS8001	55	CR2500	42	DG60003	104	FT10001	48
BC2012	18	BN2012	12	BS8003	55	CR3000	44	DG60013	123	FT11001	48
BC2201	22	BN2031	56	BS9110	52	CR4100	40	DG60103	74	FT12001	48
BC2511	22	BN3010	12	BS9999	8	CR4500	42	DG61003	74	FT3000	48
BC3011	18	BN6001	12	BT1200	30	CR5100	42	DG6150	84	HS1100	106
BC3201	22	BN7001	36	BT4001	30	CR5500	44	DG6160	82	LB1000	54
BC6301	22	BN8010	36	BT6001	30	CR6000	42	DT1050	32	LC6100	104
BC8301	22	BN8043	36	BT8001	30	CR6100	42	DT1051	32	LC6200	91
BD5010	30	BN8110	36	CA1002	118	CS4550	108	DT1052	32	LC6210	91
BD5012	30	BN8143	36	CA1004	118	CS7000	26	DT1053	32	MA0100	110
BD5501	30	BN9009	36	CA1006	118	DB1000	34	DT1054	32	MA0125	109
BD6610	30	BO1001	36	CA1007	118	DB5000	40	EL01033	12	MA0320	106
BD7501	30	BR1001	24	CA1008	118	DG0036	106	EL02003	6	MA0322	106
BD7701	30	BR2001	24	CA1010	118	DG0038	106	EL04003	36	MA60003	104
BK1010	6	BR3001	24	CA2000	118	DG0039	106	EL05003	30	MA60103	74
BK1011	55	BS1010	6	CA3000	118	DG0040	106	EL0608	30	MA61003	74



Order No.	Page	Order No.	Page	Order No.	Page	Order No.	Page	Order No.	Page	Order No.	Page
MC0001	116	MC3230	116	NF1024	92	NG3300	34	PH0312	110	SH1000	123
MC0030	122	MC3637	116	NF1030	92	NG3400	16	PH0313	110	SK1000	46
MC0031	116	MG0125	106	NF1033	92	NG3500	16	PH0315	110	SN1000	54
MC0063	120	MG1003	106	NF10403	78	NG3610	28	PH1307	110	SP1007	48
MC0066	120	MG1006	106	NF10433	78	NG3700	28	PH2040	102	SP1010	48
MC0067	120	MG1010	94	NF3778	106	NG3710	28	PH3100	102	SP2500	58
MC0072	120	MG1013	94	NF60003	104	NG3800	38	PH4016	102	SP2510	59
MC0073	120	MG1030	94	NF60103	74	NG8000	13	PH5000	91	SP2550	58
MC0101	116	MG1033	94	NF61003	74	NG8002	14	PH6400	98	SP2560	59
MC0102	116	MG10503	78	NF6150	84	NG8050	13	PH6410	98	SP2591	59
MC0103	116	MG10533	78	NF6160	82	NG8100	13	PH6600	98	SP2592	59
MC0130	116	MG1620	110	NG1000	6	NG8150	7	PH6610	98	SP2595	59
MC0156	120	MG60003	104	NG1003	4	NG8152	8	PH6800	98	SP2600	59
MC0161	120	MG60103	74	NG1005	4	NG8162	8	PH6810	98	SP2700	58
MC0204	116	MG61003	74	NG1100	34	NG8200	7	PV1000	53	SP2710	58
MC0232	116	MG6150	84	NG1107	20	NG8250	7	RB1000	4	SP2720	58
MC0302	116	MG6161	82	NG1200	20	NG8300	14	RB1400	4	SP2730	59
MC0311	116	MG70003	104	NG1600	38	NG8350	7	RB3000	8	SP2740	59
MC0320	120	MG70103	74	NG1700	20	NG8402	14	RB4000	48	SP7250	49
MC0360	116	MG71003	74	NG1800	20	NG9100	47	RC1000	24	SP7300	50
MC0380	116	NB1000	65	NG1810	25	NG9200	47	RC2000	24	SP7700	46
MC1601	120	NB1100	65	NG1910	52	NG9300	47	RC2200	24	SP81005	64
MC1700	116	NB3000	65	NG2000	12	NG9400	45	RC3300	26	SP8200	64
MC1730	116	NC5000	42	NG2002	10	NG9500	45	RD2010	25	TB1000	10
MC1800	116	NC5100	40	NG2004	10	NG9600	50	RG1000	51	UH1000	54
MC1830	116	NC5200	40	NG3000	6	NG9610	50	RM8050	123	YT1000	30
MC2000	116	NF0037	106	NG3002	10	NG9700	50	SC1000	54	YT10004	42
MC2030	116	NF0125	108	NG3003	4	PC1100	62	SC1300	30	YT1100	28
MC3000	116	NF1000	84	NG3100	16	PC2000	62	SC1400	30	YT1200	28
MC3030	116	NF1015	88	NG3200	34	PC3000	62	SC1500	28	YT3000	32
MC3100	116	NF1018	88	NG3210	38	PC6000	63	SC8000	28	YT3300	32
MC3130	116	NF1021	92	NG3220	34	PC6100	63	SG1000	53		
MC3200	116	NF1022	88	NG3230	38	PH0310	110	SG6000	14		



Noga Engineering and Technology (2008) Ltd.
P.O.B. 55. Dora Industrial Park
Shlomi 2283200, Israel
Tel: 972-4-9808080
Fax: 972-4-9808638
E-mail: noga@noga.com
www.noga.com