

4Czech[®]

CZECH REPUBLIC - Industry Line



RUČNÍ NÁŘADÍ
HAND TOOLS
HANDWERKZEUGE

Nástroje nás baví,
MY JSME NÁSTROJE!



NÁSTROJE CZ, s.r.o.

Riegrova 399
CZ-697 01 Kyjov
Česká republika

IČO: 27674207
DIČ: CZ27674207

Značku **4CZech** jsme po důkladném zvážení založili z důvodu pokračující české tradice ručního nářadí. I když naše specializace je výroba obráběcích nástrojů **NÁSTROJE CZ**, máme **25 letou** zkušenost s prodejem a zpětnou vazbou od zákazníků na veškeré české ruční nářadí. Rozhodli jsme se oslovit nejlepší světové výrobce a podle našich výkresů pokračovat v české tradici výroby ručního nářadí. Tak jako naši předkové, i my jsme začali nejprve vybírat kvalitní vstupní materiály pro výrobu našeho profesionálního nářadí **4CZech**. Samozřejmě tento proces byl zdlouhavý a přícházely i těžké chvíle. Díky péči a houževnatosti jsme došli k nejlepšímu poměru výkon/cena našich výrobků. Vyvíjíme a vyrábíme ruční nářadí **4CZech** pro profesionální uživatele nejrůznějších oblastí. Na naše nářadí se musí spolehnout při každodenním intenzivním používání. Každý náš výrobek byl vytvořen s přihlédnutím na největší požadavky našich zákazníků. Každý výrobek se snažíme promyslet do posledního detailu. Než přijde výrobek na trh, projde náročným testováním u nás ve firmě a poté se testuje v ostrém provozu u našich zákazníků. Pomocí získaných informací výrobek zlepšíme a dovedeme k dokonalosti. Velký důraz klademe na design, povrchovou úpravu a finální zabalení výrobku. Výrobek se musí dostat k našim zákazníkům v bezvadném stavu tak, aby překonal strasti dopravy. Tak jako obráběcí nástroje **NÁSTROJE CZ**, i ruční nářadí **4CZech** je 100% kontrolováno, než odejde z našeho výrobního závodu. Každý výrobek je vizuálně zkontrolován, přeměřen jak z pohledu délkových rozměrů, tak z pohledu kvality materiálu, jeho složení a tvrdosti. V každé šarži výrobků děláme i fyzické zátěžové testy. Výsledkem je kvalitní profesionální nářadí, na které se můžete spolehnout i v těch nejtěžších aplikacích, pro které je určeno.

JEDNATELÉ SPOLEČNOSTI **Executive directors / Geschäftsführer**

Ing. Emil Nečasánek
Jednatel - výrobní ředitel
Executive director - production director
Geschäftsführer - Produktionsleiter
Tel.: +420 515 553 611
Fax: +420 515 553 612
E-mail: necasane@nastrojecz.cz



Pavel Šitina
Jednatel - ekonomický ředitel
Executive director - economic director
Geschäftsführer - Wirtschaftsleiter
Tel.: +420 515 553 600
Fax: +420 515 553 605
E-mail: sitina@nastrojecz.cz



NÁSTROJE CZ, s.r.o.

Riegrova 399
CZ-697 01 Kyjov
Czech Republic

IČO: 27674207
DIČ: CZ27674207

After careful consideration, we founded the **4CZech** brand because of the continuing Czech tradition of hand tools. Although our specialty is the production of machining tools **NÁSTROJE CZ**, we have **25 years** of experience in sales and feedback from customers on all Czech hand tools. We decided to approach the world's best manufacturers and, according to our drawings, continue the Czech tradition of manufacturing hand tools. Just like our forefathers, we first started to select quality input materials for the production of our **4CZech** professional tools. Of course, this process was lengthy and there were difficult moments. Thanks to diligence and tenacity, we have reached the best performance/price ratio for our products. We develop and manufacture **4CZech** hand tools for professional users in various fields. They must rely on our tools for intensive daily use. Each of our products has been created taking into account the greatest demands of our customers. We try to think through each product down to the last detail. Before the product comes to the market, it goes through demanding testing at our company and is then tested in real-life conditions at our customers. Using the obtained information, we improve the product and bring it to perfection. We place great emphasis on the design, surface treatment and final packaging of the product. The product must reach our customers in perfect condition so as to overcome the difficulties of transportation. Just like **NÁSTROJE CZ** machining tools, **4CZech** hand tools are 100% inspected before they leave our factory. Each product is visually inspected, remeasured both from the point of view of length dimensions as well as material quality, its composition and hardness. We also perform physical stress tests in each batch of products. The result is a professional tool that you can rely on even in the most difficult applications for which it is intended.

NÁSTROJE CZ, s.r.o.

Riegrova 399
CZ-697 01 Kyjov
Tschechien

IČO: 27674207
DIČ: CZ27674207

Aufgrund der anhaltenden tschechischen Tradition von Handwerkzeugen gründeten wir nach sorgfältiger Überlegung die Marke **4CZech**. Obwohl unsere Spezialisierung die Herstellung von Bearbeitungswerkzeugen **NÁSTROJE CZ** ist, haben wir **25 Jahre** Erfahrung im Verkauf und Feedback von Kunden zu allen tschechischen Handwerkzeugen. Wir trafen eine Entscheidung, uns an die weltbesten Hersteller zu wenden und nach unseren Zeichnungen die tschechische Tradition der Herstellung von Handwerkzeugen fortzusetzen. Genau wie unsere Vorfahren begannen wir auch zunächst mit der Auswahl von hochwertigen Ausgangsmaterialien für die Herstellung unserer **4CZech**-Profiwerkzeuge. Dieser Prozess war natürlich langwierig und es gab schwierige Momente. Dank Fleiß und Beharrlichkeit erreichten wir für unsere Produkte das beste Preis-Leistungsverhältnis. Wir entwickeln und produzieren **4CZech**-Handwerkzeuge für professionelle Anwender in verschiedenen Bereichen. Auf unsere Werkzeuge kann man sich im intensiven täglichen Gebrauch verlassen. Jedes unser Produkt wurde unter Berücksichtigung der höchsten Anforderungen unserer Kunden entwickelt. Wir versuchen jedes Produkt bis ins kleinste Detail zu durchdenken. Bevor das Produkt auf den Markt kommt, durchläuft es anspruchsvolle Tests in unserer Firma und wird anschließend unter realen Bedingungen bei unseren Kunden getestet. Anhand der gewonnenen Informationen verbessern wir das Produkt und perfektionieren es. Wir legen großen Wert auf Design, Oberflächenbehandlung und Endverpackung des Produkts. Das Produkt muss in einwandfreiem Zustand bei unseren Kunden ankommen. Sowohl die Bearbeitungswerkzeuge **NÁSTROJE CZ** als auch die Handwerkzeuge **4CZech** werden zu 100 % geprüft, bevor sie unser Werkstatt verlassen. Jedes Produkt wird visuell geprüft, sowohl hinsichtlich der Längenabmessungen als auch hinsichtlich der Materialqualität, seiner Zusammensetzung und Härte nachgemessen. Außerdem führen wir bei jeder Produktcharge physikalische Belastungstests durch. Das Ergebnis ist ein professionelles Qualitätswerkzeug, auf das Sie sich auch bei den schwierigsten Anwendungen, für die es bestimmt ist, verlassen können.



OBCHODNÍ ODDĚLENÍ Sales Department / Verkaufsabteilung

Obchodní oddělení - kancelář Dobruška
Sales department - Dobruška office
Verkaufsabteilung - Büro Dobruška
Křovická 1047
CZ-518 01 Dobruška

tel.: +420 491 615 785
fax.: +420 491 615 789
e-mail: info@nastrojecz.cz
URL: www.nastrojecz.cz

Jiří Pithart
Obchodní ředitel
Business Manager
Vertriebsleiter
mobil: +420 777 581 100
e-mail: pithart@nastrojecz.cz
skype: [nastrojecz.pithart](https://www.skype.com/people/nastrojecz.pithart)



Ing. Rastislav Rakovský
Vedoucí prodeje pro Slovensko
Business manager for Slovakia
Sales Manager für die Slowakei
mobil: +421 948 962 696
e-mail: rakovsky@nastrojecz.cz
skype: [rastislav_r](https://www.skype.com/people/rastislav_r)



Kamil Rybin
Technická podpora
Technical support
Technischer Support
mobil: +420 777 581 265
tel.: +420 373 700 677
e-mail: rybin@nastrojecz.cz



Mgr. Lenka Švédová
Obchodní referentka - EXPORT
Business Assistant - EXPORT
Business Officer - EXPORT
mobil: +420 775 862 527
e-mail: export@nastrojecz.cz
skype: [nastrojecz.export](https://www.skype.com/people/nastrojecz.export)



Bc. Kristýna Zezulková
Obchodní referentka
Business Assistant
Business Officer
mobil: +420 702 296 483
e-mail: zezulkova@nastrojecz.cz



Petra Šnobllová
Obchodní referentka
Business Assistant
Business Officer
mobil: +420 777 581 299
tel.: +420 491 615 785
e-mail: snobllova@nastrojecz.cz
skype: [snobllova.petra.nastrojecz](https://www.skype.com/people/snobllova.petra.nastrojecz)



OBCHODNÍ ZÁSTUPCE Sales representative / Verkäufer

Martin Novotný
obchodní zástupce pro region Čechy - severní část
Sales representative for the region Bohemia - northern part
Außendienstmitarbeiter für das Verkaufsgebiet Böhmen - Nordteil
mobil: +420 702 013 653
e-mail: novotny@nastrojecz.cz



Zdeněk Faltejsek
obchodní zástupce pro region Čechy - jižní část
Sales representative for the region Bohemia - southern part
Außendienstmitarbeiter für das Verkaufsgebiet Böhmen - Südteil
mobil: +420 702 158 061
e-mail: faltejsek@nastrojecz.cz



Martin Zezulka
obchodní zástupce pro region Morava - západní část
Sales representative for the region Moravia - western part
Außendienstmitarbeiter für das Verkaufsgebiet Mähren - Westteil
mobil: +420 777 581 136
e-mail: zezulka@nastrojecz.cz



Roman Trávníček
obchodní zástupce pro region Morava - východní část
Sales representative for the region Moravia - eastern part
Außendienstmitarbeiter für das Verkaufsgebiet Mähren - Ostteil
mobil: +420 777 581 266
e-mail: travnicek@nastrojecz.cz



Peter Virdzek
Obchodní zástupce pro region sever a západ Slovenska
Sales representative for the region of northern and western Slovakia
Außendienstmitarbeiter für das Verkaufsgebiet Slowakei - Nordteil und Westteil
mobil: +421 940 656 301
e-mail: virdzek@nastrojecz.cz



Roman Miniar
Obchodní zástupce pro region střední Slovensko
Sales representative for the region of middle Slovakia
Außendienstmitarbeiter für das Verkaufsgebiet Slowakei - Zentraler Teil
mobil: +421 948 319 829
e-mail: miniara@nastrojecz.cz



Jozef Imrich
Obchodní zástupce pro region východní Slovensko
Sales representative for the region of eastern Slovakia
Außendienstmitarbeiter für das Verkaufsgebiet Slowakei - Ostteil
mobil: +421 948 256 726
e-mail: imrich@nastrojecz.cz





ZNAČKOVÉ PRODEJNY Brand stores / Marken-Shops

Značková prodejna Bučovice
Brand store Bučovice
Marken-Shop Bučovice
Nádražní 560, CZ-685 01 Bučovice
mobil: +420 775 380 844
tel.: +420 515 553 603
e-mail: bucovice@nastroje.cz

Značková prodejna Dobruška
Brand store Dobruška
Marken-Shop Dobruška
Křovická 1047, CZ-518 01 Dobruška
mobil: +420 606 086 884
tel.: +420 491 615 788
e-mail: dobruska@nastroje.cz

Značková prodejna Plzeň
Brand store Plzeň
Marken-Shop Plzeň
Sladkovského 449/7, CZ-326 00 Plzeň
mobil: +420 722 928 400
tel.: +420 373 700 675
e-mail: plzen@nastroje.cz

Značková prodejna Lanškroun
Brand store Lanškroun
Marken-Shop Lanškroun
Nádražní 1, CZ-563 01 Lanškroun
mobil: +420 727 955 130
tel.: +420 491 615 787
e-mail: lanškroun@nastroje.cz

ZÁSTUPCI ZNAČKOVÝCH PRODEJEN Representatives of brand stores / Vertreter von Markenshops



Miroslav Kosa
Vedoucí maloobchodního střediska Bučovice
Retail Centre Manager Bučovice
Leiter des Einzelhandelszentrums Bučovice
GSM: +420 775 380 844
E-mail: kosa@nastroje.cz



Pavel Hvězda
Vedoucí maloobchodního střediska Dobruška
Retail Centre Manager Dobruška
Leiter des Einzelhandelszentrums Dobruška
GSM: +420 720 041 381
E-mail: hvezda@nastroje.cz



Andrea Mlezivová
Vedoucí maloobchodního střediska Plzeň
Retail Centre Manager Plzeň
Leiter des Einzelhandelszentrums Plzeň
GSM: +420 722 928 400
E-mail: mlezivova@nastroje.cz



Pavel Beneš, DIS.
Vedoucí maloobchodního střediska Lanškroun
Retail Centre Manager Lanškroun
Leiter des Einzelhandelszentrums Lanškroun
GSM: +420 727 955 130
E-mail: benes@nastroje.cz



Pavel Musil
Obchodní zástupce pro pobočku Bučovice
Sales representative for the brand store Bučovice
Außerdienstmitarbeiter für Filiale Bučovice
GSM: +420 601 546 818
E-mail: musil@nastroje.cz



Jan Tomáš
Obchodní zástupce pro pobočku Dobruška
Sales representative for the brand store Dobruška
Außerdienstmitarbeiter für Filiale Dobruška
GSM: +420 722 488 139
E-mail: tomas@nastroje.cz



Karel Vileta
Obchodní zástupce pro pobočku Plzeň
Sales representative for the brand store Plzeň
Außerdienstmitarbeiter für Filiale Plzeň
GSM: 420 725 440 241
E-mail: vileta@nastroje.cz



Patrik Tauer
Obchodní zástupce pro pobočku Lanškroun
Sales representative for the brand store Lanškroun
Außerdienstmitarbeiter für Filiale Lanškroun
GSM: +420 725 548 797
E-mail: tauer@nastroje.cz



VÝROBNÍ ZÁVOD A CENTRÁLNÍ SKLAD ŽDÁNICE Production plant and central warehouse / Produktionsanlage und Zentrallager

Výrobní závod a centrální sklad
Production plant and central warehouse
Produktionsanlage und Zentrallager
Areál Šroubárny Ždánice, Nádražní 418
CZ-696 32 Ždánice
tel.: +420 515 553 601
fax: +420 515 553 610

Reklamační
Complaints
Reklamation
tel.: +420 515 553 601
e-mail: reklamace@nastroje.cz

Vedoucí skladu
Warehouse Manager
Lagermanager
Ladislav Dufek
tel.: +420 515 553 611
fax: +420 515 553 610
e-mail: dufek@nastroje.cz



Obchodní referentka, fakturantka
Business assistant, invoice clerk
Kaufmännische Assistentin, Schreiber
Vladimíra Lungová
tel.: +420 515 553 609
fax: +420 515 553 610
e-mail: lungova@nastroje.cz



Obchodní referentka, expedice
Business assistant, expedition
Kaufmännische Assistentin, Expedition
Anna Konečná
tel.: +420 515 553 615
fax: +420 515 553 610
e-mail: konecna@nastroje.cz



Ekonomika - hlavní účetní
Economy - main accountant
Ökonomie - Chief Accountant
Emilie Varmužová
tel.: +420 515 553 611
fax: +420 515 553 612
e-mail: varmuzova@nastroje.cz



Výroba - vedoucí výroby
Production department - production manager
Produktion - Produktionsleiter
Antonín Slampa
mobil.: +420 777 581 124
tel.: +420 515 553 608
fax: +420 515 553 610
e-mail: slampa@nastroje.cz





Firma NÁSTROJE CZ, s.r.o. vznikla dne 2. února 2006. Hlavní činností je výroba a vývoj spirálových vybrušovaných vrtáků a jejich prodej po celé ČR i v rámci Evropy. Navázali jsme na bohaté zkušenosti firmy EN NÁSTROJE s.r.o., která se problematikou vrtní zabývá již od roku 1992.

V roce 2011 dochází ke spojení s firmou VELKOBOCHOD NÁSTROJŮ ŠITINA s.r.o., čímž dochází k významnému kapitálovému posílení společnosti, ale zejména přichází znalosti s obchodem a výrobou závitníků. Toto spojení firem bylo logickým vyústěním jejich činností v oblasti obrábění otvorů, závitování a prodeje se snahou o přetavení a skloubení mnohaletých zkušeností v jeden celek. A to jak z výrobní, tak i z obchodní sféry. Vzniká moderní obchodně-výrobní, životaschopná společnost. V roce 2014 byla dokončena celková rekonstrukce objektu v bývalém areálu Šroubárny ve Žďánicích. Bylo vytvořeno moderní prostředí pro výrobu, skladování, administrativu, školící a testovací zázemí. Firma NÁSTROJE CZ s.r.o. se specializuje na výrobu a vývoj spirálových vybrušovaných vrtáků do kovů. Výrobní závod firmy je vybavený technologií firem GÜHRING, NORMAC, HAUX, MIKROSA, MITUTOYO. Kvalita výrobků je pravidelně kontrolována a výrobky jsou po ní označeny nálepkou TK. Systematicky pracujeme na zlepšování kvality výrobků a poskytovaných služeb.

Firma NÁSTROJE CZ, s.r.o. je vlastníkem několika patentů (ochranných vzorů) a registrovaných značek. Především se jedná o unikátní geometrii CZ002 a CZ004, která byla vyvinuta na základě

dlouholetých zkušeností a testováním v oboru obrábění otvorů. Tato revoluční geometrie byla oceněna na několika výstavách jak v tuzemsku, tak v zahraničí. Kvalita a výkon našich vrtáků CZ002 a CZ004 v porovnání s konkurencí byla testována VUT v Brně.

V roce 2012 byla vytvořena ochranná známka 4CZech, pod kterou firma NÁSTROJE CZ, s.r.o. vyrábí dotahovací a ruční nářadí. Firma je zároveň vlastníkem ochranné známky Český výrobek.

V dnešní době firma NÁSTROJE CZ, s.r.o. vyrábí pod svoji značkou CZ ucelený sortiment vrtáků do kovu, kamene a dřeva, závitníků a brusiva a je stabilním dodavatelem nářadí a nástrojů nejen na evropském, ale zejména na českém a slovenském trhu.

Specializací je obrábění kovu. V moderním skladě na ploše 2000 m² se nachází více jak 34tis položek od tuzemských i evropských značek. Hodnota skladu v prodejní ceně je cca 27mil EUR.

Prioritou společnosti je dodržování obchodní politiky a zajištění vysoce kvalitních služeb pro zákazníka. Naše obchodní politika a dodavatelský servis nám umožňuje dodávat širokému spektru zákazníků, od velkoobchodů, přes prodejce až po konečné spotřebitele. Dodržování kodexu slušného chování v obchodním styku je samozřejmostí.

Potřeby a zájmy zákazníka jsou pro nás na prvním místě. Díky stále se zdokonalující logistice jsme schopni vykrývat zakázky po České a Slovenské republice s více než 95% úspěšností. Zboží dodáváme do 24h po objednání. Obchodně poradenský servis pro obchodníky v Čechách a na Slovensku

zajišťuje síť vyškolených obchodních zástupců. Abychom byli schopni poskytnout profesionální servis pro koncové uživatele, máme v České republice čtyři maloobchodní střediska. Zde pracují specializovaní obchodní zástupci a prodavači, kteří poskytují informace s rozsáhlou specializací.

Jelikož klademe velký důraz na fyzické předvádění našich výrobků, nabízíme Vám několik možností jak je otestovat.

První možností je návštěva maloobchodních středisek v Bučovicích, Dobrušce, Lanškrouně a Plzni, kde si můžete prohlédnout a otestovat většinu našich výrobků, převážně v ručních strojích.

Druhá možnost je objednání mobilního testovacího vozu VW Crafter, který je vybaven stojanovou vrtáčkou FLOTT a dalšími stroji NAREX. Tento demovůz je k dispozici kdekoli v Evropě s proškoleným obchodním zástupcem.

Třetí možností je testovací CNC stroj, který je součástí školícího a testovacího střediska ve Žďánicích.

Společnost NÁSTROJE CZ, s.r.o. velkou část zisku investuje do nových výrobních a informačních technologií, vzdělání zaměstnanců a vytváření příjemného pracovního prostředí. Samozřejmostí je podpora školství, kultury, zábavy, a to nejen v regionu sídla firmy, ale také v celé České a Slovenské republice.



The company NASTROJE CZ was established on 2nd February 2006. The main activities are production and development of ground twist drills and their sale in the Czech Republic as well as within Europe. We followed rich experience of the company EN NASTROJE which has been dealing with the questions of drills since 1992. In 2011 there was fusion with the company VELKOBOCHOD NASTROJŮ ŠITINA, which caused not only important capital strength of the company but also brought knowledge of business and taps production. This fusion of the two companies was the logical outcome of their activities in the area of holes machining, tapping and sales with the effort for transforming and combining many years' knowledge into one whole from the production and business point

of view. It is the birth of a modern, viable trade and production company.

In 2014 the complete reconstruction of the building in the former premises of „Šroubárny“ in Žďánice was finished. The production hall, warehouse, administration, training and testing centres are situated there.

The company NASTROJE CZ specializes in production and development of ground twist drills for metal. The company's production hall is equipped with the technology GÜHRING, NORMAC, HAUX, MIKROSA, MITUTOYO companies.

The quality of goods is regularly checked and the products are marked by a label „TK“ after each

check. We are systematically working on quality and service improvement.

The company NASTROJE CZ is the owner of several patents (trademarks) and registered marks. It is mainly unique geometry CZ002 and CZ004 which was developed on the basis of long-time experience and testing in the field of holes machining. This revolutionary geometry was awarded at several fairs both in the Czech Republic and also abroad. The quality and performance of our drills CZ002 and CZ004 was tested at Brno University of Technology in comparison with other competitors.

The trademark 4CZech was established in 2012. We produce fastening and hand tools under this



mark. The company is also an owner of a trademark „Czech product“.

Nowadays the company NASTROJE CZ produces a whole range of drills for metal, stone and wood; taps and abrasive under its own trademark. It is a stable supplier of tools not only on European but especially on Czech and Slovak markets. It mainly specializes in metal machining. There are more than 34 thousand products of domestic and European brands in a modern warehouse of the area 2000 m². The value of the warehouse is around 27 million EUR in a purchase price.

The company's priority is maintaining business politics and providing high quality service for a customer. Our business politics and supply service enable us to supply wide spectrum of customers from wholesale stores through salesmen to end users. Keeping codex of good manners in business relations is natural for us. We put our customers' needs

and interests first. We are able to complete orders within the Czech Republic and Slovakia with more than 95% of success due to our continuously improving logistics. We deliver the goods within 24 hours after placing an order.

The net of professionally trained sales representatives provides trade consulting service in the Czech Republic and Slovakia.

We have four retail stores in the Czech Republic so that we are able to provide professional service for end users. There are professional sales representatives and salesmen who provide information with large specialization.

Since we put stress on physical presentation of our products, we offer several possibilities how to test them.

The first possibility is to visit our retail stores in Bučovice, Dobruška, Lanškroun or Plzeň where

you can see and test most of our products, especially in hand-held machines.

The second possibility is to book a mobile testing vehicle VW Crafter which is equipped with a drill press FLOTT and other machines NAREX. This demo-vehicle is available anywhere in Europe with a professionally trained sales representative.

The third possibility is a testing CNC machine which is part of our training and testing centre in Žďánice.

The company NASTROJE CZ invests large part of its profit into new production and information technologies, education of employees and creation of pleasant working environment. It also focuses on support of education, culture, entertainment not only in the region of the company's headquarters but also in the whole Czech Republic and Slovakia.



 Die Firma NÁSTROJE CZ, s.r.o. ist am 2. Februar 2006 entstanden. Die Haupttätigkeit ist Herstellung und Entwicklung der geschliffenen Spiralbohrer im ehemaligen Sroubárny-Areal in der Stadt Žďánice und Verkauf nicht nur in der ganzen Tschechischen Republik, sondern auch im Rahmen Europas. Man hat an reiche Erfahrungen der Firma EN NÁSTROJE s.r.o. angeknüpft, die sich mit der Bohrerproblematik schon seit dem Jahr 1992 befasst.

Im Jahr 2011 kommt es zu einer Fusion mit der Firma VELKOBOCHOD NÁSTROJŮ ŠITINA s.r.o., was zu einer bedeutenden Kapitalkräftigung der Gesellschaft geführt hat, aber vornehmlich kommen die Geschäftskenntnisse und Kenntnisse der Erzeugung von Gewindebohrer dazu. Diese Firmenverbindung betrachtet man als einen logischen Ausgang im Bereich der Löcherbearbeitung mit der Bemühung um Umformung und Verbindung der langjährigen Erfahrungen in einen Komplex. Und das sowohl in der Produktions-, als auch in der Geschäftssphäre.

Im Jahr 2014 wurde eine Gesamtrekonstruktion des Objekts in Žďánice beendet. Man hat eine moderne Umwelt für die Produktion, Lager, Administration, Schulungs- und Testeinrichtungen geschaffen.

Die Firma NÁSTROJE CZ, s.r.o. spezialisiert sich auf die Produktion und Entwicklung der geschliffenen Spiralbohrer für Stahl. Der Herstellungsbetrieb ist mit der Technologie der Firmen GÜHRING, NORMAC, HAUX, MIKROSA, und MITU-TOYO ausgestattet. Die Qualität der Erzeugnisse wird regelmäßig kontrolliert und die Produkte werden mit dem TK-Etikett bezeichnet. Man arbeitet systematisch an Verbesserung der Produktqualität und Qualität von geleisteten Dienstleistungen.

Die Firma NÁSTROJE CZ, s.r.o. besitzt einige Patente (Schutzmuster) und registrierte Marken. Es

handelt sich vor allem um die unikale Geometrie CZ002 und CZ004, die aufgrund der langjährigen Erfahrungen und des Testens im Bereich der Löcherbearbeitung entwickelt wurde. Diese Revolutionsgeometrie wurde in einigen Ausstellungen sowohl im Inland, als auch im Ausland bewertet. Die Qualität und Leistung unserer Bohrer CZ002 und CZ004 wurde erfolgreich im Vergleich mit der Konkurrenz an der Technischen Hochschule in Brunn getestet.

Im Jahr 2012 wurde die Schutzmarke 4Czech gegründet, unter der die Firma NÁSTROJE CZ, s.r.o. Festzieh- und Handwerkzeug produziert. Die Firma besitzt zugleich die Schutzmarke „Tschechisches Produkt“.

In der heutigen Zeit erzeugt die Firma NÁSTROJE CZ, s.r.o. unter ihrer Marke CZ ein komplettes Sortiment von Bohrern für Stahl, Stein und Holz, von Gewindebohrern und Schleifmitteln, und ist ein stabiler Werkzeugs- und Gerätelieferant auf dem europäischen, vornehmlich auf dem tschechischen und slowakischen Markt. Die Firma spezialisiert sich auf die Stahlbearbeitung. Im modernen Lager auf einer Fläche von 2000 m² befinden sich mehr als 34 Tausend verschiedener Positionen der inländischen und europäischen Marken. Der Wert der Lagervorräte erreicht im Verkaufspreis ca. 27 Mio. Euro.

Die Priorität der Gesellschaft ist Beachtung der Geschäftspolitik und Erbringung der hochqualitativen Dienstleistungen für den Kunden. Unsere Geschäftspolitik und der Lieferservice machen es uns möglich, ein breites Kundenspektrum bedienen zu dürfen, das heißt vom Großhandel über die Verkäufer bis zum endgültigen Verbraucher. Es ist eine Selbstverständlichkeit, ethischen Kodex (anständiges Benehmen) im Handelskontakt einzuhalten. Auf dem ersten Platz stehen die Bedürfnisse und Interessen des Kunden. Dank der ständig vervollkommenden Logistik ist man fähig, die

Aufträge in der Tschechischen und Slowakischen Republik mit einer Erfolgsquote von mehr als 95% zu decken. Die Ware liefert man binnen 24 Stunden von der Bestellung.

Geschäfts- und Beratungsservice für die Geschäftsleute in Tschechien und in der Slowakei stellt ein Netz von ausgebildeten Handelsvertretern sicher. Um einen professionellen Service für Endverbraucher zu gewähren, gibt es in der Tschechischen Republik vier Einzelhandelszentren. Hier arbeiten spezialisierte Handelsvertreter und Verkäufer, die umfassende Fachinformationen bereitstellen.

Da es ein großer Wert auf das physische Präsentieren der eigenen Erzeugnisse gelegt wird, bietet die Firma einige Möglichkeiten, wie man diese durchtesten kann. Die erste Möglichkeit ist, die Einzelhandelszentren in Bučovice, Dobruška, Lanškroun und Pilsen zu besuchen, wo sich man die Mehrheit unserer Produkten, überwiegend in den Handmaschinen, ansehen und sie durchtesten kann. Die zweite Möglichkeit ist Bereitstellung des mobilen Testwagens VW Crafter, der mit einer Ständerbohrmaschine FLOTT und mit weiteren NAREX-Maschinen ausgestattet ist. Dieser Demowagen steht an jedem beliebigen Ort Europas mit einem ausgebildeten Handelsvertreter zur Verfügung. Die dritte Möglichkeit stellt eine CNC-Testmaschine dar, die ein Bestandteil des Schulungs- und Testzentrums in Žďánice ist.

Die Gesellschaft NÁSTROJE CZ, s.r.o. investiert einen großen Teil des Profits in neue Erzeugungs- und Informationstechnologien, in die Ausbildung der Mitarbeiter und die Schaffung von einem angenehmen Arbeitsumwelt.

Es gilt als selbstverständlich, Schulwesen, Kultur und Vergnügung nicht nur in der Region des Firmensitzes, sondern auch in der ganzen Tschechischen und Slowakischen Republik zu unterstützen.



OBSAH / CONTENT / INHALT

Název výrobku Product Name Produktnamen	Kód Code Bestellnummer	Obrázek Picture Bild	Strana Page Seite
1/4" Ruční nářadí 1/4" Hand tools 1/4" Handwerkzeuge	4CZ-14		<u>11</u>
3/8" Ruční nářadí 3/8" Hand tools 3/8" Handwerkzeuge	4CZ-38		<u>25</u>
1/2" Ruční nářadí 1/2" Hand tools 1/2" Handwerkzeuge	4CZ-12		<u>28</u>
3/4" Ruční nářadí 3/4" Hand tools 3/4" Handwerkzeuge	4CZ-34		<u>44</u>
1" Ruční nářadí 1" Hand tools 1" Handwerkzeuge	4CZ-10		<u>46</u>
1/2" Ruční nářadí průmyslové 1/2" Impact hand tools 1/2" Schlag-Handwerkzeuge	4CZ-P12		<u>48</u>
1/2" Hlavice na Alu kola 1/2" Socket for aluminium wheels 1/2" Steckschlüssel für Alu-Radscheiben	4CZ-72		<u>49</u>
3/4" Ruční nářadí průmyslové 3/4" Impact hand tools 3/4" Schlag-Handwerkzeuge	4CZ-P34		<u>50</u>
Černěné klíče DIN 894 Wrenches black finish DIN 894 Schlüssel Schwarz DIN 894	4CZ-894		<u>52</u>
Černěné klíče DIN 895 a sady Wrenches black finish DIN 895 and sets Schlüssel Schwarz DIN 895 und Sätze	4CZ-895		<u>53</u>
Chromované klíče DIN 3110 a sady Chromium-plated wrenches DIN 3110 and sets Schlüssel Verchromt DIN 3110 und Sätze	4CZ-600		<u>56</u>
Chromované klíče DIN 3113 + sady Chromium-plated wrenches DIN 3113 + sets Schlüssel Verchromt DIN 3113 + Sätze	4CZ-277		<u>58</u>
Chromované klíče ISO1711-1 + sady Chromium-plated wrenches ISO1711-1 + sets Schlüssel Verchromt ISO1711-1 + Sätze	4CZ-277R		<u>60</u>
Klíče očkové ráčnové kloubové Double flex-joint ratchet wrenches Knarren-Ring-Maulschlüssel mit Gelenk	4CZ-278RK		<u>62</u>
Klíče očkové ráčnové otočné Bone ratchet wrenches with swivel head Knarrenschlüssel drehbar	4CZ-279		<u>63</u>
Chromované klíče DIN 838 a sady Chromium-plated wrenches DIN 838 and sets Schlüssel Verchromt DIN 838 und Sätze	4CZ-838		<u>64</u>
Trubkové klíče Tubular box spanners Rohrsteckschlüssel	4CZ-653		<u>66</u>
Trubkové klíče kované Tubular box spanners forged Rohrsteckschlüssel Geschmiedet	4CZ-653HQ		<u>67</u>
Klíče na převlečné matice Flare nut wrenches Offene Ringschlüssel	4CZ-410		<u>68</u>
Klíče na převlečné matice ráčnové Flare nut wrenches ratchet Knarren-Offener Doppelringschlüssel	4CZ-410R		<u>69</u>



OBSAH / CONTENT / INHALT

Název výrobku Product Name Produktnamen	Kód Code Bestellnummer	Obrázek Picture Bild	Strana Page Seite
Zástrčné šestihranné klíče a sady Hexagon key L-wrenches and sets 6-kant-Winkelschraubendreher und Sätze	4CZ-710		<u>70</u>
Bity a sady Bits and sets Bits und Sätze	4CZ-80		<u>73</u>
Svěráky Vices Schraubstöcke	4CZ-SV		<u>85</u>
Kleště kombinované All purpose pliers Kombizange	4CZ-351		<u>89</u>
Kleště štípací boční a čelní Side cutting pliers and Carpenter's pincers Seitenschneider und Kneifzange	4CZ-335, 4CZ-304		<u>90</u>
Kleště štípací čelní Carpenter's pincers Kneifzangen	4CZ-310, 4CZ-310P		<u>91</u>
Kleště armovací Reinforcement pliers Rabitzzangen	4CZ-2313		<u>92</u>
Kleště SIKO Adjustment water pump pliers Wasserpumpenzange	4CZ-366, 4CZ-366K, 4CZ-366P, 4CZ-366R		<u>93</u>
Kleště na drát Wire pliers Verdrahtungszangen	4CZ-319, 4CZ-321		<u>95</u>
Kleště pro jemnou mechaniku Pliers for fine Mechanics Zangen für die Feinmechanik	4CZ-2305, 4CZ-2306		<u>96</u>
Kleště odizolovací Wire stripping pliers Abisolierzangen	4CZ-2300		<u>97</u>
Kleště na pojistné kroužky Circlip pliers Sicherungsringzange	4CZ-2325, 4CZ-2326 4CZ-2327, 4CZ-2328		<u>98</u>
Kleště pro jemnou mechaniku Pliers for fine Mechanics Zangen für die Feinmechanik	4CZ-35xM, 4CZ-230xM		<u>99</u>
Kleště štípací na tyče a svorníky Bolt cutters Bolzenschneider	4CZ-270, 4CZ-270NN		<u>102</u>
Hasáky Pipe wrenches Rohrzangen	4CZ-HS		<u>103</u>
Kleště na olejové filtry Oil filter pliers Ölfilterzange	4CZ-OIL-10		<u>103</u>
Elektrikářské šroubováky a sady el. šroubováků Insulated screwdrivers and sets of insulated screwdrivers Elektriker Schraubendreher und El. Schraubendreher-Sätze	4CZ-803, 4CZ-804		<u>104</u>
Elektrikářské šroubováky a sady el. šroubováků Insulated screwdrivers and sets of insulated screwdrivers Elektriker Schraubendreher und El. Schraubendreher-Sätze	4CZ-833		<u>106</u>
Šroubováky a sady Screwdrivers and sets Schraubendreher und Sätze	4CZ-839		<u>109</u>
Mikro šroubováky a sady mikro šroubováků Precision screwdrivers and sets of precision screwdrivers Micro Schraubendreher und Micro Schraubendreher-Satz	4CZ-833		<u>115</u>



Název výrobku Product Name Produktnamen	Kód Code Bestellnummer	Obrázek Picture Bild	Strana Page Seite
Šroubováky JUMBO Screwdrivers JUMBO Schraubendreher JUMBO	4CZ-70, 4CZ-71 4CZ-87, 4CZ-99		117
Šroubováky Screwdrivers Schraubendreher	4CZ-801, 4CZ-802 4CZ-808		119
Šroubováky Screwdrivers Schraubendreher	4CZ-831		120
Kladiva, kladiva předtloukácí Hammers, sledgehammers Hämmer, Vorschlaghämmer	4CZ-28, 4CZ-18		121
Kladiva tesařská Carpenter's hammer Zimmermannshämmer	4CZ-51, 4CZ-52		122
Sekera Axe Axt	4CZ-56		124
Palice Mallets Fäustel	4CZ-603, 4CZ-603P 4CZ-53, 4CZ-54, 4CZ-55		125
Páčidla Claw bars, wrecking bars Krallenstange, Brecheisen	4CZ-60, 4CZ-64, 4CZ-65		128
Sekáče Chisels Meißel	4CZ-63, 4CZ-62		129
Pilníky a sady pilníků Files and file sets Feilen und Feilen-Sätze	4CZ-211		130
Rašple a sady rašplí Rasp and rasp sets Raspeln und Raspeln-Sätze	4CZ-221		135
Svinovací metry Tape measures Taschenrollbandmähse	4CZ-SM		137
Vytahovače zalomených šroubů s vrtákem Extractors of broken screws with a drill bit Schraubenausdreher mit Bohrer	4CZ-VZS		138
Trháky matic Nut splitters Mutternsprenger	4CZ-TM		139
Skříčidla a příslušenství Drill chucks and accessories Bohrfutter und Zubehör	4CZ-H		140
Trny pro skříčidla Drill chuck arborea Spanndornen und Bohrfutter	SM-D29, 4CZ-HT-MK		143
Redukční pouzdra Morse taper sleeves Reduktionshülsen	SM-D40, SM-D45		144
Vyrážecí klíny Key drivers Austreiber	241279		145
Hliníkové lišty do T drážky Aluminium cover strips for T-slot Aluminium Abdeckleisten für T-Nut	BW-T		146



SYMBOLY / SYMBOLS / SYMBOLE

Rozměr / Dimension / Abmessung



Symboly materiálů / Material symbols / Materialsymbole



Symboly norem ISO, DIN a ČSN / Symbols for ISO, DIN and ČSN standards / Symbole für ISO, DIN - und ČSN-Normen

ISO 1174 ISO 1174-1 ISO 1711-2 ISO 2725-1 ISO 2725-2	ISO 1173 ISO 3315 ISO 3316	ISO 15601	ISO 239	ISO 2236 ISO 1085	ISO 272	ISO 2725-1 ISO 2725-2	DIN 3120 DIN 3121 DIN 3122 DIN 3123	DIN 3124 DIN 3126 DIN 3129	ISO 691 ISO 1711-1 ISO 3318 ISO 10102	ISO 7738 ISO 3318 ISO 10104	NF-E 74 331 ISO 2936	ISO 9001	ČSN 242140	ČSN 242145
ČSN 241279	ČSN 241320	ČSN 241323	ČSN 241329	ASME B107.100	DIN 238	DIN 1041	DIN 1042	DIN 2185	DIN 2187	DIN 3110	DIN 3113	DIN 3118	DIN 6349	DIN 7261
DIN 7263	DIN 838	DIN 894	DIN 896	DIN 895	DIN 911	DIN 3110	DIN 3113	DIN 3118	DIN 6349	DIN 7261	DIN 7263			

Tvrdość / Hardness / Härte



Symboly pro stopky / Symbols for drill's shank / Symbole für Bohrer Schaft



Symboly povrchových úprav vrtáků / Symbols for drill's surface finish / Symbole für Bohrer Oberflächenbehandlung



Doplňkové pictogramy / Additional pictograms / Zusätzliche Piktogramme

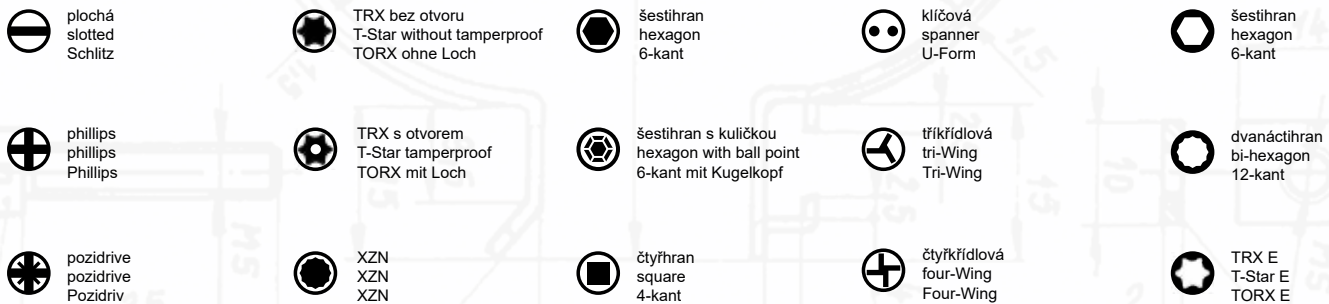
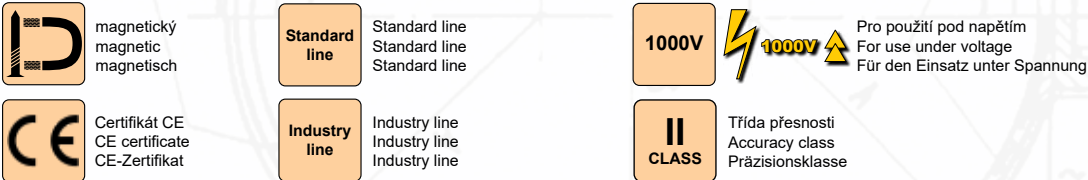

Označené položky jsou dostupné i na závěsném EUROCLIPu.
The marked items are also available in the hang-EUROCLIP.
Markierte Artikel sind auch am hängenden EUROCLIP erhältlich.

Pro objednání se závěsným EUROCLIPem přidejte do objednáacího kódu položky písmeno "S" dle vzoru níže.
To order with a hang-EUROCLIP, add the letter "S" to the item number according to the pattern below.
Um mit einem hängenden EUROCLIP zu bestellen, fügen Sie dem Bestellcode des Artikels den Buchstaben "S" gemäß dem untenstehenden Muster hinzu.





HLAVICE 4CZech ONE SOCKET 4CZech ONE DER 4CZech ONE STECKSCHLÜSSEL-EINSATZ

4CZech® ONE

Hlavice 4CZech ONE byla navržena, aby se rozšířila oblast kontaktu a předešlo se poškození šestihřanné matice.
4CZech ONE socket was designed to spread the contact area and to prevent damage to the hex nut.

Der 4CZech ONE Steckschlüssel-Einsatz wurde entwirft, um das Kontaktbereich zu erweitern und dadurch die Beschädigung der Sechskant-Schraubenmutter zu eliminieren.

Hlavice 4CZech ONE
Úhel zkosení menší než 1° zajišťuje tzv. „liniový“ kontakt mezi hlavici a maticí, který chrání okraj matice před poškozením.

Socket 4CZech ONE
Less than 1° bevel angle design, 4CZech ONE socket supply a „Line“ contact between socket and nut, which protects the nut corner from being damaged.

Der 4CZech ONE Steckschlüssel-Einsatz
Schrägwinkel kleiner als 1° sichert sog. „Linienkontakt“ zwischen dem Steckschlüssel-Einsatz und Schraubenmutter, der die Schraubenmutter vor Beschädigung schützt.

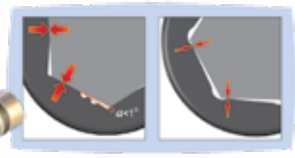

Obyčejná hlavice
Kontakt matice s hranou, okraj matice se dá lehce poškodit a ten tak zůstává opotřebený.

Conventional Socket
Conventional socket contact the nut with point, it is easily to damage nut corner and become rounded.

Üblicher Steckschlüssel-Einsatz
Kontakt der Schraubenmutter mit der Kante, der Rand kann man leicht beschädigen und bleibt abgenutzt

Výsledek testu 1: Díky „liniovému“ kontaktu hlavice 4CZech ONE zůstává tvar zkušební matice u hlavice po testu stejný, avšak okraje zkušební matice u obyčejné hlavice jsou po testu poškozené.
Test Results 1: Total contact 4CZech ONE Socket tester-nut remains very good shape after test, but Conventional Socket's tester-nut corners are damaged after test.
Test Ergebnis: Dank Dem „Linienkontakt“ bleibt der 4CZech ONE Steckschlüssel-Einsatz gleich, der Üblicher Steckschlüssel-Einsatz ist beschädigt.

Hlavice 4CZech ONE
Povrch a hrana zkušební matice zůstává stejný po testu s hlavici 4CZech One.

Socket 4CZech ONE
The surface and corner of tester-nut remain very good shape after driven by total Contact 4CZech ONE Socket.

4CZech ONE
Steckschlüssel-Einsatz – Die Oberfläche und Kante des Steckschlüssel-Einsatzes bleibt gleich.

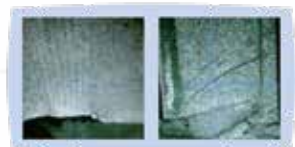

Obyčejná hlavice
Okraje zkušební matice jsou poškozené po testu s obyčejnou hlavici.

Conventional Socket
The tester-nut corners are damaged after driven by Conventional socket.

Üblicher Steckschlüssel-Einsatz
Die Oberfläche und Kante des Steckschlüssel-Einsatzes sind beschädigt.

Výsledek testu 2: Hlavice 4CZech ONE má perfektní kontakt s maticí, užitím síly se záběr může roznést rovnoměrně přes matici.
Test results 2: Socket 4CZech ONE totally contacts with nut, so, the torque can evenly spread over nut while applied power.
Test Ergebnis Nr. 2: 4CZech ONE Steckschlüssel-Einsatz hat perfekten kontakt mit der Schraubenmutter und trägt gleichmäßig die Kraft.

Hlavice 4CZech ONE
Všech šest hran matice má perfektní kontakt s hlavici 4CZech One, užitím síly se záběr může roznést rovnoměrně přes hlavu matice, takže zkušební matice je po testu s hlavici 4CZech One utržena stejnoměrně.

Socket 4CZech ONE
Because six faces of nut totally contact with 4CZech ONE socket, the torque can evenly spread over nut head while applied power, so, the tester-nut is evenly broken after test by 4CZech ONE socket.

4CZech ONE Steckschlüssel-Einsatz
Alle sechs Kanten haben perfekten Kontakt mit dem 4CZech Steckschlüssel-Einsatz, die Kraft wird gleichmäßig getragen, die Schraubenmutter bleibt nach dem Test mit 4CZech ONE Steckschlüssel-Einsatz gleichmäßig abgerissen.



Obyčejná hlavice
Matice spojuje pouze několik určitých bodů obyčejné hlavice, užitím síly se záběr nemůže roznést rovnoměrně přes hlavu matice, takže zkušební matice není po testu s obyčejnou hlavici utržena stejnoměrně.

Conventional Socket
The nut joins only few certain points of the conventional socket, the torque can't evenly spread over the nut head while applied power so, the tester-nut is unevenly broken after test by conventional socket.

Üblicher Steckschlüssel-Einsatz
Schraubenmutter wird nur durch weniger Punkte mit dem Steckschlüssel-Einsatz verbunden, die Kraft wird nicht gleichmäßig getragen, die Schraubenmutter bleibt nicht nach dem Test mit Üblichem Steckschlüssel-Einsatz gleichmäßig abgerissen.

Limit Factor Analysis (stress-distributed test): design vysokého výkonu hlavice 4CZech ONE využívá menší koncentraci namáhání, usnadňuje práci a šetří čas.
Belastungstest: Der Hochleistung design des 4CZech ONE Steckschlüssel-Einsatzes nutzt niedrigere Belastungskonzentration, macht Arbeit einfacher und spart Zeit.

Hlavice 4CZech ONE
Zelená barva znázorňuje liniový kontakt hlavice 4CZech One, snižuje koncentraci namáhání jak hlavice, tak zkušební matice.

Socket 4CZech ONE
Less green color shows 4CZech One socket's line contact. It reduces both socket and tester-nut stress concentration.

Grüne Farbe Zeigt den „Linienkontakt“ des 4CZech ONE Steckschlüssel-Einsatz, und mindert Belastungskonzentration der Test-Schraubenmutter und Üblicher Schraubenmutter.

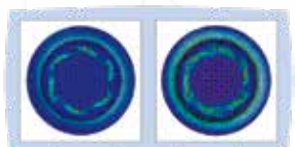

Obyčejná hlavice
Zelená barva znázorňuje větší koncentraci namáhání jak u obyčejné hlavice, tak u zkušební matice.

Conventional Socket
More green color shows that both conventional socket and tester-nut bear much more stress concentration.

Grüne Farbe Zeigt die Belastungskonzentration der Test Schraubenmutter und Üblicher Schraubenmutter.

Přínos: Hlavice 4CZech ONE má vynikající využití u poškozených matic, až do 85% opotřebení.
Benefit: 4CZech ONE socket always succeeds in those rounded nuts, especially up to 85% rounded nuts.
4CZech ONE Steckschlüssel-Einsatz hat perfekte Nutzung bis zum Verschleiß von 85% der Schraubenmutter.

Patent: Hlavice 4CZech ONE byla opatřena americkým a německým patentem.
Patented: 4CZech ONE socket was awarded USA and Germany patent.
4CZech ONE Steckschlüssel-Einsatz erhielt Amerikanische und Deutsche Patent.

Typ hlavice / Socket type / Steckschlüssel-Einsatz Typ

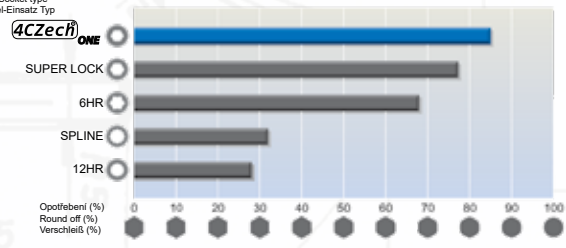



Kód / Code / Bestellnummer
4CZ-14

1/4"

Industry line

CrV

ISO 1174-1
 ISO 1711-2
 ISO 2725-1
 ISO 2725-2

ISO 1173
 ISO 3315
 ISO 3316

DIN 3120
 DIN 3122
 DIN 3123

DIN 3124
 DIN 3126
 DIN 3129

POUŽITÍ

USABILITY

VERWENDUNG

Nabízíme ucelený sortiment utahovacího nářadí. Klasické hlavice nástrčné, zástrčné, prodloužené, kardany, prodlužovací nástavce, redukce, vratidla, adaptéry, sady hlavice a další příslušenství velikosti 1/4". Speciální hlavice s patentovanou technologií 4CZech ONE pro perfektní kontakt s maticí umožňující povolit i zcela poškozené matici a zabránit jejímu poškození. Zátěžové ráčny vysoké kvality s revolučním převodem.

We offer a complete range of tightening tools. Classic hex bit and torx sockets, prolonged sockets, universal joints, extension bars, bit couplers, adapters, sliding T handle bars, bit couplers, socket sets and other accessories - sizes 1/4". Special sockets with patented technology 4CZech ONE for perfect contact with a nut enabling to loosen even completely damaged nuts and prevent their damage. High-quality heavy-duty ratchets with the revolutionary gear.

Wir bieten eine umfassende Palette von Handwerkzeugen. Klassische-Steckschlüssel, Einsätze, verlängerte Steckschlüssel, Kardangelenke, Verlängerungen, Reduktionen, Gleitgriffen, Adapter, Steckschlüsselsätze und anderes Zubehör - 1/4". Spezieller Steckschlüssel mit patentierter 4CZech-ONE-Technologie für perfekten Kontakt mit Mutter ermöglicht das Lösen auch komplett beschädigter Muttern und verhindert deren Beschädigung. Hochwertige Belastungsknarren mit revolutionärem Getriebe.

ISO 2725-1
 ISO 1711-2
 ISO 2725-2
 DIN 3124

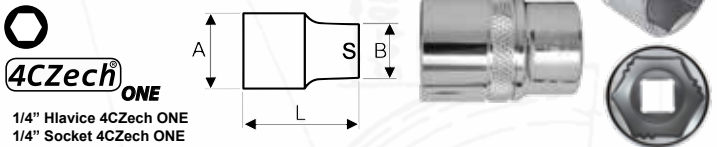

1/4" Hlavice 4CZech ONE
 1/4" Socket 4CZech ONE
 1/4" Steckschlüssel 4CZech ONE

kód/Code Bestellnummer	S (mm)	L (mm)	A (mm)	B (mm)	W (g)		DPC/RRP (Kč/czk)	DPC/RRP (EUR)	EAN13
4CZ-141-02-04	4,0	24,9	11,8	6,6	9	10	30,99	1,29	8592667037533
4CZ-141-02-045	4,5	24,9	11,8	7,3	10	10	30,99	1,29	8592667037540
4CZ-141-02-05	5,0	24,9	11,8	8,0	10	10	30,99	1,29	8592667037557
4CZ-141-02-055	5,5	24,9	11,8	8,6	10	10	31,98	1,33	8592667037564
4CZ-141-02-06	6,0	24,9	11,8	9,2	10	10	31,98	1,33	8592667037571
4CZ-141-02-07	7,0	24,9	11,8	10,7	11	10	32,81	1,37	8592667037588
4CZ-141-02-08	8,0	24,9	11,3	11,8	11	10	32,81	1,37	8592667037595
4CZ-141-02-09	9,0	24,9	11,9	12,7	13	10	32,81	1,37	8592667037601
4CZ-141-02-10	10,0	24,9	11,9	14,2	14	10	33,80	1,41	8592667037618
4CZ-141-02-11	11,0	24,9	13,9	15,8	18	10	33,80	1,41	8592667037625
4CZ-141-02-12	12,0	24,9	13,9	16,8	21	10	33,80	1,41	8592667037632
4CZ-141-02-13	13,0	24,9	13,9	17,8	22	10	33,80	1,41	8592667037649
4CZ-141-02-14	14,0	24,9	13,9	19,8	28	10	57,85	2,41	8592667037656

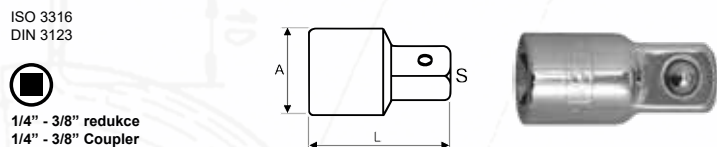

1/4" - 3/8" redukce
 1/4" - 3/8" Coupler
 1/4" - 3/8" Reduktion

kód/Code Bestellnummer	S	L (mm)	A (mm)	W (g)		DPC/RRP (Kč/czk)	DPC/RRP (EUR)	EAN13
4CZ-145-01-380	3/8"	25,5	12,1	16	10	77,69	3,24	8592667037526

Hmotnost
 Weight
 Gewicht

4CZech® ONE

Demoblok se 4 hlavicemi
 Demonstration block with 4 sockets
 Demonstrationsblock mit 4 Stecknüssen

kód/Code Bestellnummer	A (mm)	B (mm)	W (g)		DPC/RRP (Kč/czk)	DPC/RRP (EUR)	EAN13
4CZ-111-01	103	39	400	1	697,52	29,06	8592667104266

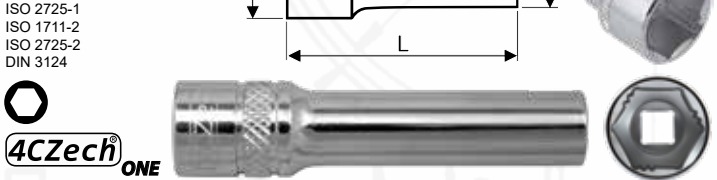

1/4" Prodloužená hlavice 4CZech ONE
 1/4" Long-reach socket 4CZech ONE
 1/4" Steckschlüssel verlängert 4CZech ONE

kód/Code Bestellnummer	S (mm)	L (mm)	A (mm)	B (mm)	W (g)		DPC/RRP (Kč/czk)	DPC/RRP (EUR)	EAN13
4CZ-141-03-04	4,0	49,7	11,8	6,8	15	10	50,41	2,10	8592667037663
4CZ-141-03-05	5,0	49,7	11,8	7,9	18	10	50,41	2,10	8592667037670
4CZ-141-03-055	5,5	49,7	11,8	8,6	19	10	50,41	2,10	8592667037687
4CZ-141-03-06	6,0	49,7	11,8	9,2	19	10	50,41	2,10	8592667037694
4CZ-141-03-07	7,0	49,7	11,8	10,6	20	10	50,41	2,10	8592667037700
4CZ-141-03-08	8,0	50,0	11,3	11,8	22	10	51,24	2,13	8592667037717
4CZ-141-03-09	9,0	50,0	11,9	13,0	28	10	51,24	2,13	8592667037724
4CZ-141-03-10	10,0	50,0	11,9	14,6	32	10	51,24	2,13	8592667037731
4CZ-141-03-11	11,0	50,0	13,9	15,8	38	10	51,24	2,13	8592667037748
4CZ-141-03-12	12,0	50,0	13,9	16,8	40	10	54,55	2,27	8592667037755
4CZ-141-03-13	13,0	50,0	13,9	17,8	42	10	54,55	2,27	8592667037762
4CZ-141-03-14	14,0	50,0	13,9	19,8	52	10	71,90	3,00	8592667037779

ISO 3315
 DIN 3122

**1/4" Kloubové vratidlo
 1/4" Hinged Handle
 1/4" Gelenkgriff**

kód/Code Bestellnummer	L (mm)	A (mm)	B (mm)	W (g)		DPC/RRP (Kč/czk)	DPC/RRP (EUR)	EAN13
4CZ-145-06-150	150,0	15,5	10,8	98	10	150,41	6,27	8592667038073

ISO 1174-1



kód/Code Bestellnummer	S	L (mm)	A (mm)	B (mm)	W (g)		DPC/RRP (Kč/czk)	DPC/RRP (EUR)	EAN13
4CZ-143-01-04	E4	24,9	5,9	11,8	9	10	100,83	4,20	8592667037786
4CZ-143-01-05	E5	24,9	6,9	11,8	10	10	100,83	4,20	8592667037793
4CZ-143-01-06	E6	24,9	8,0	11,8	10	10	100,83	4,20	8592667037809
4CZ-143-01-07	E7	24,9	9,4	11,8	10	10	100,83	4,20	8592667037816
4CZ-143-01-08	E8	24,9	10,3	11,8	10	10	100,83	4,20	8592667037823
4CZ-143-01-10	E10	24,9	11,9	13,5	17	10	116,53	4,86	8592667037830
4CZ-143-01-11	E11	24,9	11,9	13,5	17	10	116,53	4,86	8592667037847



**1/4" Vratidlo
 1/4" Sliding bar (T handle)
 1/4" Gleitgriff**

kód/Code Bestellnummer	L (mm)	A (mm)	W (g)		DPC/RRP (Kč/czk)	DPC/RRP (EUR)	EAN13
4CZ-145-05-115	110,0	6,2	43	10	118,18	4,92	8592667038080

Informace o balení na straně 9
 Packing information on page 9
 Verpackungsinformationen auf Seite 9

Vyvedené ceny jsou DPC (doporučené prodejní ceny) v Kč a EUR bez DPH.
 All prices mentioned are DPC (RRP - recommended retail price) in CZK and EUR without VAT.
 Alle Preise sind EV-Preise (empfohlene Verkaufspreise) in CZK und EUR ohne MwSt.



ISO 3316
DIN 3123

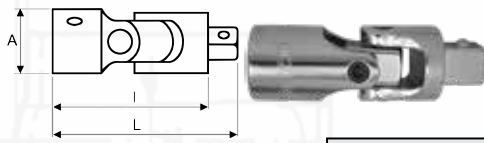

1/4" Univerzální kardan
1/4" Universal Joint
1/4" Universal-Kardangelen



kód / Code	L (mm)	I (mm)	A (mm)	W (g)		DPC/RRP (Kč/czk)	DPC/RRP (EUR)	EAN13
4CZ-145-07-034	37	30	14	26	10	186,78	7,78	8592667038103

ISO 3316
DIN 3123

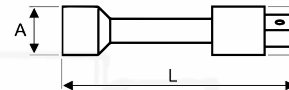

1/4" Nástavec zajišťovací
1/4" Locking extension bar
1/4" Verriegelbare Verlängerung



kód/Code Bestellnummer	L (mm)	A (mm)	B (mm)	W (g)		DPC/RRP (Kč/czk)	DPC/RRP (EUR)	EAN13
4CZ-145-02-090	90,0	11,9	13,0	50	10	66,94	2,79	8592667038035
4CZ-145-02-115	115,0	11,9	13,0	59	10	106,61	4,44	8592667038042
4CZ-145-02-165	165,0	11,9	13,0	79	10	109,92	4,58	8592667038059

ISO 1173
DIN 3126

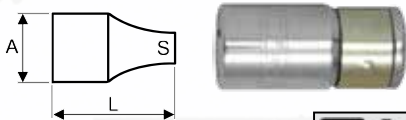

1/4" Adaptér na bity HexF
1/4" Bit holder HexF
1/4" Bittadapter HexF



kód / Code	S	L (mm)	A (mm)	W (g)		DPC/RRP (Kč/czk)	DPC/RRP (EUR)	EAN13
4CZ-145-11-140	1/4"	25,5	11,9	13	10	71,07	2,96	8592667038097

ISO 3316
DIN 3123

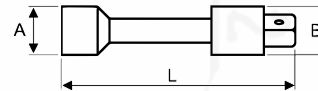

1/4" Nástavec pružinový
1/4" Flexible Extension Bar
1/4" Flexibel Verängerung



kód/Code Bestellnummer	L (mm)	A (mm)	B (mm)	W (g)		DPC/RRP (Kč/czk)	DPC/RRP (EUR)	EAN13
4CZ-145-03-150	150,0	11,9	11,9	60	10	192,56	8,02	8592667038066

ISO 3315
DIN 3122

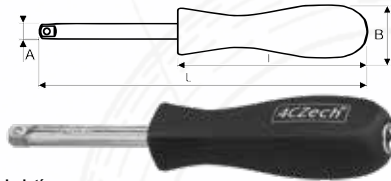

1/4" Nástavec s rukojetí
1/4" Spinner Handle
1/4" Verlängerung mit Handgriff



kód/Code Bestellnummer	L (mm)	I (mm)	A (mm)	B (mm)	W (g)		DPC/RRP (Kč/czk)	DPC/RRP (EUR)	EAN13
4CZ-145-02-150	150,0	91,0	8,2	25,6	94	10	156,20	6,51	8592667124004

[Zajišťovací nástavec - na straně 12](#)
[Locking extension bars - on page 12](#)
[Verriegelbare Verlängerung - auf Seite 12](#)

[Informace o balení na straně 9](#)
[Packing information on page 9](#)
[Verpackungsinformationen auf Seite 9](#)

4Czech®

Zajišťovací nástavec Locking extension bars Verriegelbare Verlängerung

- Bezpečný uzamykatelný design, nástroj je uvnitř upevněn, neuvolní se, dokud není uvolněn zamykací mechanismus.
- Jednoduché ovládání - jednoduché uzamčení nástroje pouze jedním prstem
- Speciální uzamykatelný design zabraňuje skřípnutí prstů
- Jednoduché uvolnění zamykacího mechanismu pouhým stiskem
- Estetický design
- Safety locking mechanism, tools are intrinsically wedged and not fall, unless the locking mechanism is pulled to release a tool.
- Simple operation - Locking a tool simply with one finger.
- Special locking mechanism design avoids fingers being pinched.
- Easy to release a tool by pulling the lock mechanism.
- Esthetic design

- Sichere und abschließbare design, Das Werkzeug ist innen befestigt und löst sich nicht bis Mann den Schließmechanismus nicht lockert.
- Einfache Bedienung - Einfache Verschließung nur mit einem Finger
- Sichere abschließbare design Vermindert Fingerklemmung
- Einfache Lösung des Schließmechanismus durch einen druck
- Ästhetische design



Neklouzávý design povrchu nástavce, jednoduchý stisk, zabraňuje zranění při manipulaci.

Non-slipper design on lock mechanism surface, easy to pull and not pinch fingers.

Unrutschige design Oberfläche des Einsatz, einfache druck, vermindert Verletzung bei der Manipulation



Jednoduché zamknutí - velmi snadno pouze jedním prstem
Easy Lock - locking a tool with very simple Pop push by one finger.

Einfache Verschließung - sehr einfach mit einem Finger

Vysoký záběr, nástavec vyroben z vysoce kvalitní chromvanadiové oceli.

High torque, made of high grade Chrome Vanadium Steel.

Höhe Leistung, der Ansatz besteht aus einer Hochqualitäts - Chromvanadium Stahl, gemustert gegen rutschen

- Tradiční nástavec**
- Upevnění nástroje bez bezpečnostního zámku
 - Není jednoduché upevnit nástroj, nutné vynaložení větší síly
 - Je obtížné vysunout nástroj, nutné vynaložení větší síly
 - k vytažení nástroje z nástavce
 - Je zapotřebí užití obě ruce, k upevnění i vytažení nástavce

- Traditional extension bars**
- Attaching a tool without safety lock.
 - Not easy to attach a tool - expend more force to push an extension bar into a tool.
 - Hard to remove a tool - need more expenditure of force to remove a tool from an extension bar.
 - Need two hands operation - need two hands to attach or remove tools from an extension bar.

- Üblicher Ansatz**
- Befestigung des Werkzeuges ohne Sicherheitschloss
 - Es ist nicht einfach das Werkzeug einzuspannen
 - Man braucht mehr Kraft
 - Es ist Mühsam das Werkzeug herauszuziehen, man braucht mehr Kraft
 - Beide Hände sind brauchbar



Normální uzamykatelný nástavec

- Se zamykacím mechanismem, nástroje jsou pevně upevněny k nástroji
- Jednodušší upevnění nástroje, s využitím zamykacího mechanismu
- Rychlé uvolnění nástroje, s využitím zamykacího mechanismu
- I když má zamykací mechanismus, je také zapotřebí užití obě ruce k upevnění a uvolnění nástroje

- Normal locking extension bars**
- With lock mechanism - tools can be firmly attached by the lock mechanism.
 - Easier to attach a tool - easier to attach a tool if pull the lock mechanism.
 - Quick release a tool - a tool can be quick released from an extension bar as pull the lock mechanism.
 - Need two hands operation - although it has a locking mechanism, it also needs two hands simultaneously operate the attaching or removing action.

- Üblicher Abschließbare Ansatz**
- Das Mechanismus hält das Werkzeug fest
 - Einfachere Einspannung des Werkzeuges
 - Schnelle Abkoppelung
 - Obwohl das Mechanismus abschließbar ist, braucht man beide Hände.



ISO 2725-1
ISO 1174-1
DIN 3124

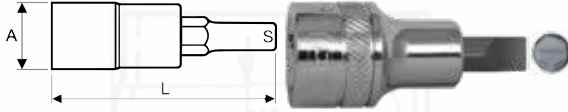

1/4" Zástrčná hlavice plochá
1/4" Slotted bit socket
1/4" Steckschlüssel-Einsatz Schlitz

kód/Code Bestellnummer	S	B	L (mm)	A (mm)	W (g)	DPC/RRP (Kč/czk)	DPC/RRP (EUR)	EAN13
4CZ-142-10-04	SL4	0,8	36,9	11,9	14	10	50,41	8592667138797
4CZ-142-10-055	SL5,5	1	37,3	11,9	14	10	50,41	8592667138803
4CZ-142-10-07	SL7	1,2	37,3	11,9	16	10	50,41	8592667138810

ISO 1174-1

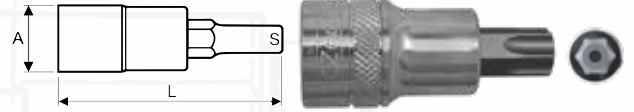

1/4" Zástrčná hlavice TRX s otvorem
1/4" TORX Bit socket with hole
1/4" Steckschlüssel-Einsatz TRX mit Loch

kód/Code Bestellnummer	S (mm)	L (mm)	A (mm)	W (g)	DPC/RRP (Kč/czk)	DPC/RRP (EUR)	EAN13
4CZ-142-06-08	TT8	36,9	11,9	14	10	72,73	8592667138650
4CZ-142-06-10	TT10	36,9	11,9	14	10	72,73	8592667138667
4CZ-142-06-15	TT15	37,1	11,9	14	10	72,73	8592667138674
4CZ-142-06-20	TT20	37,1	11,9	14	10	73,55	8592667138681
4CZ-142-06-25	TT25	37,1	11,9	14	10	72,73	8592667138698
4CZ-142-06-27	TT27	37,1	11,9	16	10	72,73	8592667138704
4CZ-142-06-30	TT30	37,1	11,9	16	10	72,73	8592667138711
4CZ-142-06-40	TT40	37,1	11,9	16	10	72,73	8592667138728

ISO 2725-1
ISO 1174-1
DIN 3124

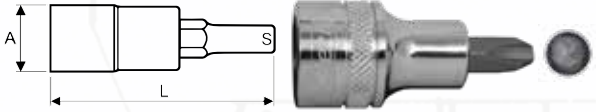

1/4" Zástrčná hlavice phillips
1/4" Phillips Bit socket
1/4" Steckschlüssel-Einsatz Phillips

kód/Code Bestellnummer	S	L (mm)	A (mm)	W (g)	DPC/RRP (Kč/czk)	DPC/RRP (EUR)	EAN13
4CZ-142-09-01	PH1	36,9	11,9	14	10	50,41	8592667138766
4CZ-142-09-02	PH2	36,9	11,9	14	10	50,41	8592667138773
4CZ-142-09-03	PH3	36,9	11,9	16	10	50,41	8592667138780

ISO 2725-1
ISO 1174-1
DIN 3124



1/4" Zástrčná hlavice čtyřhranná
1/4" Square Bit socket
1/4" Steckschlüssel-Einsatz 4-kant

kód/Code Bestellnummer	S	L (mm)	A (mm)	W (g)	DPC/RRP (Kč/czk)	DPC/RRP (EUR)	EAN13
4CZ-142-13-0	SQ0	41,9	11,9	15	10	53,72	8592667042438
4CZ-142-13-1	SQ1	41,9	11,9	16	10	53,72	8592667042445
4CZ-142-13-2	SQ2	41,9	11,9	17	10	53,72	8592667042452
4CZ-142-13-3	SQ3	41,9	11,9	17	10	53,72	8592667042469

ISO 2725-1
ISO 1174-1
DIN 3124

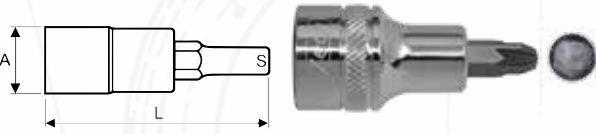

1/4" Zástrčná hlavice pozidrive
1/4" Pozidrive Bit socket
1/4" Steckschlüssel-Einsatz Pozidriv

kód/Code Bestellnummer	S	L (mm)	A (mm)	W (g)	DPC/RRP (Kč/czk)	DPC/RRP (EUR)	EAN13
4CZ-142-08-01	PZ1	36,9	11,9	14	10	50,41	8592667138735
4CZ-142-08-02	PZ2	37,3	11,9	14	10	50,41	8592667138742
4CZ-142-08-03	PZ3	37,3	11,9	16	10	50,41	8592667138759

ISO 2725-1
ISO 1174-1
DIN 3124



1/4" Zástrčná hlavice klíčová
1/4" Spanner Bit socket
1/4" Steckschlüssel-Einsatz U-Form

kód/Code Bestellnummer	S	L (mm)	A (mm)	W (g)	DPC/RRP (Kč/czk)	DPC/RRP (EUR)	EAN13
4CZ-142-14-04	U4	42,5	11,9	15	10	53,72	8592667042476
4CZ-142-14-06	U6	42,5	11,9	15	10	53,72	8592667042483
4CZ-142-14-08	U8	42,5	11,9	15	10	53,72	8592667042490
4CZ-142-14-10	U10	42,5	11,9	17	10	53,72	8592667042506

ISO 2725-1
ISO 1174-1
DIN 3124



1/4" Zástrčná hlavice imbus
1/4" HEX Bit socket
1/4" Steckschlüssel-Einsatz Imbus

kód/Code Bestellnummer	S (mm)	L (mm)	A (mm)	W (g)	DPC/RRP (Kč/czk)	DPC/RRP (EUR)	EAN13
4CZ-141-07-02	H2	37,1	11,9	14	10	50,41	8592667121485
4CZ-141-07-025	H2,5	36,7	11,9	15	10	50,41	8592667037892
4CZ-141-07-03	H3	36,7	11,9	15	10	50,41	8592667037908
4CZ-141-07-04	H4	36,7	11,9	15	10	50,41	8592667037915
4CZ-141-07-05	H5	36,7	11,9	15	10	50,41	8592667037922
4CZ-141-07-06	H6	36,7	11,9	16	10	50,41	8592667037939
4CZ-141-07-07	H7	37,4	11,9	18	10	50,41	8592667121492
4CZ-141-07-08	H8	37,9	11,9	20	10	60,33	8592667121508

ISO 2725-1
ISO 1174-1
DIN 3124



1/4" Zástrčná hlavice tříkřídlová
1/4" Tri-Wing Bit socket
1/4" Steckschlüssel-Einsatz Tri-Wing

kód/Code Bestellnummer	S	L (mm)	A (mm)	W (g)	DPC/RRP (Kč/czk)	DPC/RRP (EUR)	EAN13
4CZ-142-15-02	Y2	42	11,9	17	10	57,85	8592667042513
4CZ-142-15-03	Y3	42	11,9	17	10	57,85	8592667042520
4CZ-142-15-04	Y4	42	11,9	17	10	57,85	8592667042537
4CZ-142-15-05	Y5	42	11,9	17	10	57,85	8592667042544

ISO 1174-1



1/4" Zástrčná hlavice TRX
1/4" TORX Bit socket
1/4" Steckschlüssel-Einsatz TRX

kód/Code Bestellnummer	S	L (mm)	A (mm)	W (g)	DPC/RRP (Kč/czk)	DPC/RRP (EUR)	EAN13
4CZ-142-04-06	T6	37,1	11,9	14	10	57,85	8592667121515
4CZ-142-04-07	T7	37,1	11,9	14	10	57,85	8592667121522
4CZ-142-04-08	T8	37,1	11,9	14	10	60,33	8592667121539
4CZ-142-04-09	T9	37,1	11,9	14	10	60,33	8592667121546
4CZ-142-04-10	T10	37,1	11,9	14	10	60,33	8592667037946
4CZ-142-04-15	T15	37,1	11,9	14	10	60,33	8592667037953
4CZ-142-04-20	T20	37,1	11,9	14	10	60,33	8592667037960
4CZ-142-04-25	T25	37,7	11,9	15	10	60,33	8592667037977
4CZ-142-04-27	T27	37,4	11,9	16	10	60,33	8592667121553
4CZ-142-04-30	T30	37,4	11,9	16	10	60,33	8592667037984
4CZ-142-04-40	T40	37,4	11,9	16	10	60,33	8592667037991

ISO 2725-1
ISO 1174-1
DIN 3124



1/4" Zástrčná hlavice čtyřkřídlová
1/4" Four-Wing Bit socket
1/4" Steckschlüssel-Einsatz Four-Wing

kód/Code Bestellnummer	S	L (mm)	A (mm)	W (g)	DPC/RRP (Kč/czk)	DPC/RRP (EUR)	EAN13
4CZ-142-16-04	X4	42,3	11,9	17	10	57,85	8592667042551
4CZ-142-16-05	X5	42,3	11,9	17	10	57,85	8592667042568
4CZ-142-16-06	X6	42,3	11,9	17	10	57,85	8592667042575
4CZ-142-16-08	X8	42,3	11,9	17	10	57,85	8592667042582
4CZ-142-16-10	X10	42,3	11,9	17	10	57,85	8592667042599

i Informace o balení na straně 9
Packing information on page 9
Verpackungsinformationen auf Seite 9



POROVNÁNÍ VÝROBNÍHO PROCESU RÁČNY MEZI 4CZECH A OSTATNÍMI VÝROBCI.
THE COMPARISON OF MANUFACTURE PROCESS OF RATCHET HANDLE BETWEEN 4CZECH AND OTHER MAKERS.
VERGLEICH VON HERSTELLUNGSPROZESS ZWISCHEN 4CZECH UND ANDEREN HERSTELLERN.

**RUKOJEŤ
HANDLE
HANDGRIFF**



1. Vyřezání povrch po kování
1. Trimming surface after drop forged
1. Ausgeschnittene Oberfläche nach Schmieden
2. Synchronizované obrábění 6 děr zároveň na CNC strojích
2. Synchronized turning 6 holes at the same time by CNC machine
2. Synchronisiertes Bearbeiten von 6 Löchern gleichzeitig durch CNC-Maschine.
3. Přesný rozměr a jemné broušení
3. Precise diameter and fine grinding appeared
3. Genaue Abmessung und feines Schleifen.

- Vlastnosti:
- Proces vnějšího vyřezání a broušení otvoru pro získání hladšího povrchu
 - K získání přesného rozměru a stability komponentů uvnitř hlavy ráčny je užito synchronizované obrábění 6 děr zároveň, umožňuje větší záběr ráčny
 - Rukojeť ráčny vyrobena z vysoce kvalitní chromvanadiové oceli
- Features:
- Completely process of diameter trimming and grinding to obtain smoother products
 - To obtain precision size and to stabilize the components inside the head of the ratchet handle, synchronized turning 6 holes at the same time enable to give the handle more torque.
 - Handle made of high grade Chrome Vanadium Steel
- Eigenschaften:
- Prozess des externen Schneidens und Schleifens des Lochs, um eine glattere Oberfläche zu erhalten
 - Die synchronisierte Bearbeitung von 6 Löchern gleichzeitig wird verwendet, um die exakte Abmessung und Stabilität der Komponenten innerhalb des Knarrenkopfes zu erhalten, was einen größeren Eingriff der Knarre ermöglicht
 - Handgriff hergestellt aus hochwertigem verchromtem Stahl

**ZÁPADKA
PAW
RIEDEL**



1. Povrch po kování s užitím vysoce kvalitní SNCM (nikl-chrom-molybden) oceli
1. Drop forged using high quality SNCM (nickel-chrome-molybdeum) steel
1. Oberfläche nach Schmieden gemacht vom hoch- Qualität Nickel- Chrom- Molybdän Eisen
2. Řezání
2. Cutting
2. Schneiden
3. Výřez obráběním a přesné děrování
3. Trimming by lathe and precision punching
3. Exakte Lochung und Bearbeitung
4. Děrování čtyřhranu
4. Punching square drive
4. Vierkantlochung

5. Tepelné zpracování a černění
5. Heat treatment and black finish
5. Wärmebehandlung und Schwärzung

**PŘEVOD
GEAR
GETRIEBE**



1. Povrch po kování s užitím vysoce kvalitní SNCM (nikl-chrom-molybden) oceli
1. Drop forged using high quality SNCM (nickel-chrome-molybdeum) steel
1. Oberfläche nach Schmieden gemacht vom hoch- Qualität Nickel- Chrom- Molybdän Eisen
2. Vyřezání CNC stroji
2. Trimming by CNC machine
2. CNC Ausschneidung
3. Synchronizované děrování po frézování čtyřhranu
3. Synchronized punching holes at the same time after milling square drive
3. Synchronisierte Lochung nach dem Vierkant Fräsen
4. Rozměr pro přesné umístění do hlavy ráčny
4. Precise gear enable to fit the head of handle perfectly
4. Abmessung für genaue Platzierung ins Kopf

4CZECH

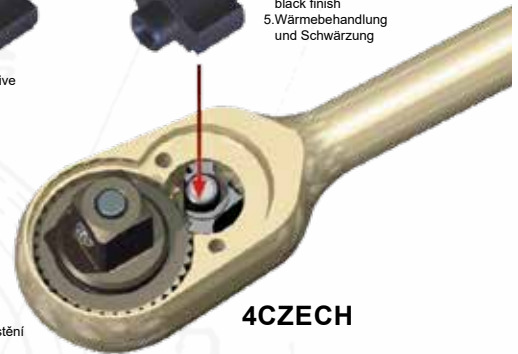

**VÍČKO
LID
KAPPE**



1. Užití technologie jemného kování k dosažení přesné a hladké hrany plus tepelné zpracování pro zajištění vysoké stabilní kvality
Vlastnost: Užitím procesu jemného kování vznikají přesné komponenty s vnitřními a vnějšími tvary, přesně vytvořené do tloušťky a plochy materiálu. Tento proces eliminuje užití dalších procesů, jako je odřezávání, frézování, vystružování, protahování a broušení.
1. Using techniques of fine blanking to cut the edge neat and smooth plus heat treatment to obtain highly stable quality
Features: Using the fine blanking process, precise finished components can be produced with inner and outer forms that are cleanly sheared over the total material thickness while achieving superior overall fitness. This process eliminated the need for costly secondary operations such shaving, milling, reaming, broaching and grinding.
1. Gebrauch von Feinschmiedetechnologie um die genaue und Glatte Kante zu erzielen plus Wärmebehandlung um hohe stabile Qualität zu garantieren.
Eigenschaft: Gebrauch von Feinschmiedeprozess entstehen präzise Komponente mit internen und externen Formen, die genau auf die Dicke von Oberfläche und Material geformt werden. Dieser Prozess eliminiert den Einsatz anderer Prozesse wie Schneiden, Fräsen, Reiben, Ziehen und Schleifen.

4CZECH

JINÉ / OTHER / ANDERE

**RUKOJEŤ
HANDLE
HANDGRIFF**



1. Částečně vyřezaný povrch
1. Partially trimming surface
1. Teilweise ausgeschnittene Oberfläche

**PŘEVOD
GEAR
GETRIEBE**



1. Bez kování, vyřezané přímo ze surového materiálu
1. Without forging, cutting from raw material directly
1. Ohne Schmieden, gleich auf dem Groben Material
2. Obrábění
2. Turning
2. Drehung

**VÍČKO
LID
KAPPE**



- K vytvoření hrany se užívá lisu, vznikají nežádoucí otěpy, některé jsou dokonce bez tepelného zpracování
- Use press machine to cut the edge and easy to get burrs, some are even without heat treatment
- Presse Benützung verursacht ungenauen Rand, manche sogar ohne Heizbearbeitung

2. Samostatné díry způsobují nepřesnou soustřednost a malý záběr ráčny, volně komponenty uvnitř hlavy ráčny snižují životnost výrobku
2. Imprecise concentricity is formed because of separately punching holes unable to give the handle more torque, besides, loosing components inside the head of handle is apt to reduce the life of product.
2. Einzellochung verursacht ungerade Kraftkonzentration und mindert den Stoß. Freie Komponenten im Kopf haben negativen Einfluss auf die die Lebensdauer

- ZÁPADKA
PAW
HERGESTELLT**
 Vyrobena z práškové metalurgie
 Made of powder metallurgy
 Hergestellt aus Pulvermetallurgie

**JINÉ ZNAČKY
OTHER BRANDS
ANDERE MARKEN**





Jednoduché a efektivní přepínání

- snadné přepínání páčky
- patentovaný přepínač
- Elegantní design hlavy**
- udržuje špínu a ostatní znečištění mimo mechanismus

Simple but Effective Switch

- easy to reverse the drive
- switch patented
- Neat head design**
- keep the dirt and contaminants out of the mechanism

Einfache und Effektive Umschaltung

- Einfache Hebel Umschaltung
- Patentierte Umschaltungs-knopf
- Elegante Design des Kopfes**
- Verschmutzungs-feste Innern Mechanismus

Precizní CNC zpracování

- precizní zpracování rukojeti na CNC stroji slouží k zajištění soustřednosti a dosažení maximálního záběru
- Vytvořená z vysoce kvalitního materiálu**
- vyrobená z vysoce kvalitní chromvanadiové oceli
- umožňuje aplikovat větší záběr

Precise process with CNC machine

- In order to form the concentricity and reach the maximum torques, synchronized turning the whole handle by CNC machine

Forged with High grade material

- made of high grade Chrome Vanadium Steel
- enable to apply more torques

Präzise CNC Bearbeitung

- Präzise Bearbeitung auf einer CNC Maschinen haftet für maximale Konzentrität

Hergestellt aus dem hoch- Qualitätät material

- Gebaut vom Chrom-Vanadium Stahl
- Ermöglicht höheren Stoß



Zabudované pojistné tlačítko

- hlavice je bezpečně upevněná a neodpojuje se, dokud se nestiskne tlačítko k uvolnění

Intrinsically safe push button

- socket is intrinsically wedged and not fallen, unless the button is pushed to release socket.

Eingebaute Sicherheitsknopf

- Der Kopf ist sicher befestigt und löst sich nicht solange Mann den Knopf drückt.



Silnější a odolnější

- 72 zubů
- každá poloha zajišťuje 11 zubů v kontaktu s převodem
- zajišťuje větší sílu a odolnost

More powerful and durable

- 72 teeth
- each turn supplies 11 teeth contacting with gear
- provide more strength and durability

Kräftiger und beständiger

- 72 Zähne
- Jede Position besorgt Kontakt von 11 Zähne mit der Übersetzung

Ergonomická rukojeť

- aerodynamický design celé ráčny
- zajišťuje pohodlné držení
- jednoduchý a hladký pohyb rukojeti v jakékoliv pozici
- pohodlné užití za každé situace

Ergonomic handle design

- whole ratchet streamline shape design
- offer comfortable holding on every position
- easily and smoothly moving from handle to every position
- offer satisfied feeling by any posture

Ergonomische Handgriff

- Aerodynamischer Design der Knarre
- Besorgt angenehme Haltung
- Einfache und reibungslose Bewegung in jeder Position
- Angenehme Benutzung in jeder Situation



PROČ SE JEDNÁ O ZÁTĚŽOVOU RÁČNU?

1. Jemné kování bez otepův, legování, víčko tepelně opracované.
2. Zařízení převodu - kování za tepla s užitím vysoce kvalitní SNCM oceli, obrobení čtyřhranu na CNC stroji, synchronizované děrování
3. Západka - kování za tepla s užitím vysoce kvalitní SNCM oceli, přesné obrobění a děrování
4. Nerezová kulička
5. Pružina
6. Držadlo ráčny - kování s užitím vysoce kvalitní CRM oceli, kvalitnější obrobění a broušení
7. Upevnění prostřednictvím nýtů
8. Přepínač

WHY IT IS HEAVY DUTY RATCHET HANDLE?

1. Fine burr-free blanking process alloy lid with heat treatment.
2. Warm drop forged high quality SNCM steel gear with CNC trimming square drive and synchronized punching holes.
3. Warm drop forged high quality SNCM steel paw precise trimming and punching
4. Stainless steel ball
5. Spring
6. Drop forged high quality CRV steel handle superior trimming and grinding
7. Tightening up with the mounted rivet
8. Switch

WIESO SICH UM EINE BELASTUNGSKNARRE HANDELT?

1. Feine Schmieden ohne Grat, Legierung, Deckel Thermisch bearbeitet.
2. Getriebe- Hoch Qualität SNCM Eisen warm geschmiedet, Viereckbearbeitung auf einer CNC Maschine, synchronisierte Lochung.
3. Der Riegel- Qualität SNCM Eisen warm geschmiedet, genaue Bearbeitung und Lochung.
4. Rostfreie Kugel
5. Feder
6. Knarre halter - Qualität CRM Eisen geschmiedet, Qualität Bearbeitung und Schleifung.
7. Befestigung durch Nieten
8. Umschalter

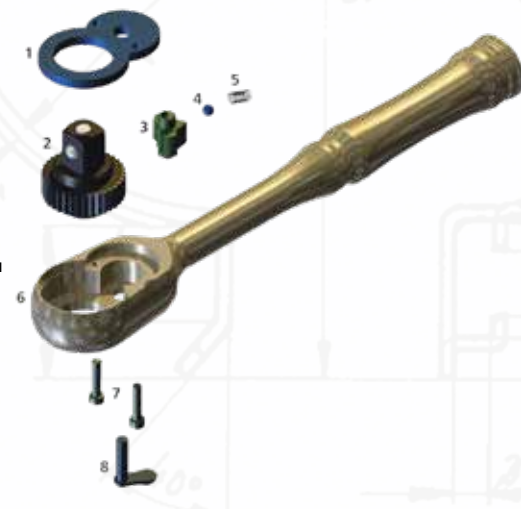

1/2" RÁČNA
1/2" RATCHET
1/2" KNARRE

VÝKON V ZÁVISLOSTI NA POČTU ZUBŮ
DIFFERENT PERFORMANCE IN DIFFERENT TEETH
LEISTUNG VERHÄLTNIS MIT ZÄHNEN ZAHL

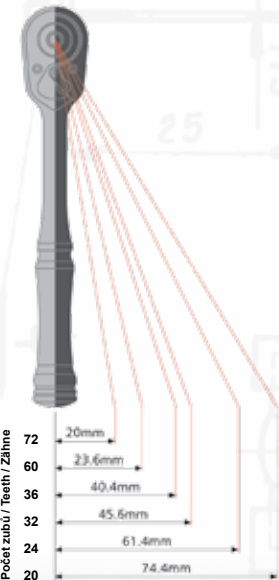

VÝSLEDKY TESTU KROUTÍCÍHO MOMENTU
TORQUE TESTING REPORT
DREHMONT TEST ERGEBNISSE

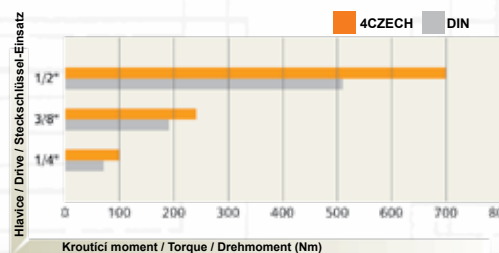

VÝSLEDKY TESTU ŽIVOTNOSTI 1/2" OVÁLNÉ RÁČNY
LIFE TIME TEST REPORT 1/2" DR. OVAL TYPE
LEBENSDAUERTEST ERGEBNIS, 1/2" DER RIEGEL-OVALER KNARRE

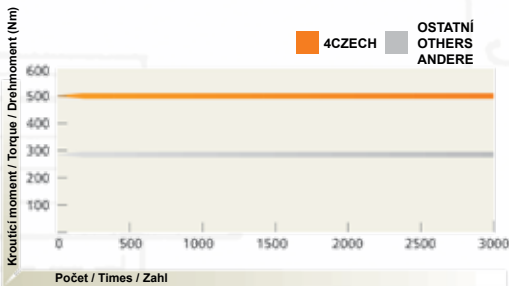



POROVNÁNÍ RÁČEN 4CZECH S OSTATNÍMI RÁČNYMI

COMPARISON OF
 4CZECH RATCHETS
 WITH OTHER ONES

VERGLEICH DER 4CZECH
 KNARREN GEGENÜBER
 ANDEREN KNARREN



4Czech®

JINÉ ZNAČKY
 OTHER BRANDS
 ANDERE MARKEN

NOVÁ REVOLUČNÍ 3D RÁČNA S VÝKYVNOU HLAVOU NEW REVOLUTIONARY 3D RATCHET WITH WOBBLE HEAD NEUE REVOLUTIONÄRE 3D-KNARRE MIT SCHWENKBAREM KOPF

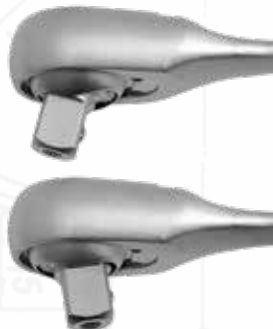

3D ráčna s patentovanou výkyvnou hlavou, která povoluje přístup k těžko dosažitelným místům, která jsou pro obvyklé ráčny zcela nepřístupná.

Vyrobena z legované oceli SCM440.

Speciálně navržená výkyvná hlava dovoluje pohyb o 30° (15° nahoru, 15° dolů).

Patented wobble head design allows access into hard to reach areas where traditional ratchets cannot reach.

Made of SCM440 Steel.

Special wobble head design provides 30° handle movement (up: 15°, down: 15°).

3D-Knarre mit einem patentierten schwenkbaren Kopf, der den Zugang zu schwer erreichbaren Stellen leistet, die für übliche Knarren ganz unzugänglich sind.

Aus legiertem SCM440-Stahl hergestellt.

Der speziell entworfene schwenkbare Kopf erlaubt Bewegung um 30° (15° nach oben, 15° nach unten).



Otáčením rukojeti ovládáte rotaci čtyřhranu hlavy ráčny

By turning the handle you control the rotation of the ratchet head square

Durch Drehen des Griffs steuern Sie die Rotation des Vierkants des Knarrenkopfes



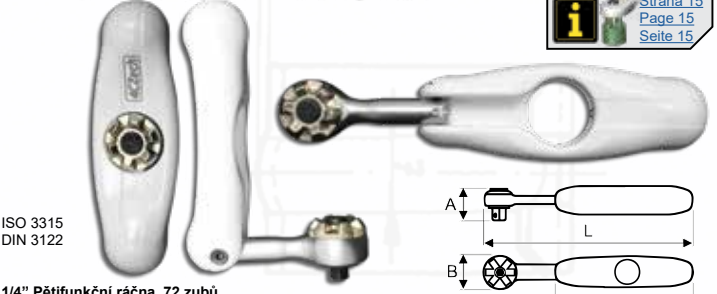

ISO 3315
DIN 3122

1/4" Pětifunkční ráčna, 72 zubů
 1/4" 5 in 1 round reversible ratchet, 72 teeth
 1/4" 5in1 Knarre, 72 Zähne

kód/Code Bestellnummer	L (mm)	I (mm)	A (mm)	B (mm)	W (g)		DPC/RRP (Kč/czk)	DPC/RRP (EUR)	EAN13
4CZ-146-06	170	118	28	26	225	10	827,27	34,47	8592667037854

Strana 15
Page 15
Seite 15

Pojistné tlačítko - na straně 15
Safe push button - on page 15
Sicherheitsknopf - auf Seite 15

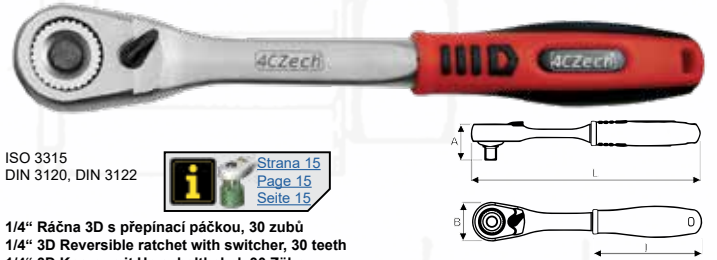

ISO 3315
DIN 3120, DIN 3122

1/4" Ráčna 3D s přepínací páčkou, 30 zubů
 1/4" 3D Reversible ratchet with switcher, 30 teeth
 1/4" 3D Knarre mit Umschalthebel, 30 Zähne

kód/Code Bestellnummer	L (mm)	I (mm)	A (mm)	B (mm)	W (g)		DPC/RRP (Kč/czk)	DPC/RRP (EUR)	EAN13
4CZ-144-08	150	75	24	23	97	10	780,99	32,54	8592667123878

Strana 15
Page 15
Seite 15



ISO 3315
DIN 3120, DIN 3122

1/4" Ráčna oválná s přepínací páčkou, 72 zubů
 1/4" Reversible oval ratchet with switcher, 72 teeth
 1/4" Ovale Knarre mit Umschalthebel, 72 Zähne

kód/Code Bestellnummer	L (mm)	I (mm)	A (mm)	B (mm)	W (g)		DPC/RRP (Kč/czk)	DPC/RRP (EUR)	EAN13
4CZ-144-01	130	62	21	22	87	10	563,64	23,48	8592667040151

Strana 15
Page 15
Seite 15



ISO 3315
DIN 3120, DIN 3122

1/4" Ráčna celokovová, 72 zubů
 1/4" Small head oval full metal ratchet, 72 teeth
 1/4" Ganzstahl-Knarre, 72 Zähne

kód/Code Bestellnummer	L (mm)	I (mm)	A (mm)	B (mm)	W (g)		DPC/RRP (Kč/czk)	DPC/RRP (EUR)	EAN13
4CZ-144-10	120	57	21	19	79	10	441,32	18,39	8592667159372

Strana 15
Page 15
Seite 15



ISO 3315
DIN 3120, DIN 3122

1/4" Ráčna s přepínacím tlačítkem, 72 zubů
 1/4" Reversible ratchet with switching button, 72 teeth
 1/4" Knarre mit Umschaltknopf, 72 Zähne

kód/Code Bestellnummer	L (mm)	I (mm)	A (mm)	B (mm)	W (g)		DPC/RRP (Kč/czk)	DPC/RRP (EUR)	EAN13
4CZ-144-02	130	60	22	22	99	10	563,64	23,48	8592667040168

Strana 15
Page 15
Seite 15

Informace o ovládání ráčny na straně 16
 See page 16 for ratchet control information
 Informationen zur Knarrensteuerung finden Sie auf Seite 16



ISO 3315
DIN 3120, DIN 3122

1/4" Ráčna s přepínacím kolečkem, 72 zubů
 1/4" Reversible ratchet with switching wheel, 72 teeth
 1/4" Knarre mit Umschaltrad, 72 Zähne

kód/Code Bestellnummer	L (mm)	I (mm)	A (mm)	B (mm)	W (g)		DPC/RRP (Kč/czk)	DPC/RRP (EUR)	EAN13
4CZ-144-03	145	63	28	24	111	10	436,36	18,18	8592667038011

Strana 15
Page 15
Seite 15



1/4" Ráčna rotační, 52 zubů
 1/4" Rotary ratchet, 52 teeth
 1/4" Rotationsknarre, 52 Zähne

kód/Code Bestellnummer	L (mm)	I (mm)	A (mm)	B (mm)	W (g)		DPC/RRP (Kč/czk)	DPC/RRP (EUR)	EAN13
4CZ-144-11	180	87	28	27	204	10	1525,62	63,57	8592667173422

Strana 15
Page 15
Seite 15



ISO 3315
DIN 3120, DIN 3122

1/4" Ráčna s přepínací páčkou, 48 zubů
 1/4" Reversible ratchet with switcher, 48 teeth
 1/4" Knarre mit Umschalthebel, 48 Zähne

kód/Code Bestellnummer	L (mm)	I (mm)	A (mm)	B (mm)	W (g)		DPC/RRP (Kč/czk)	DPC/RRP (EUR)	EAN13
4CZ-144-07	140	65	22	23	100	10	563,64	23,48	8592667109902

Strana 15
Page 15
Seite 15

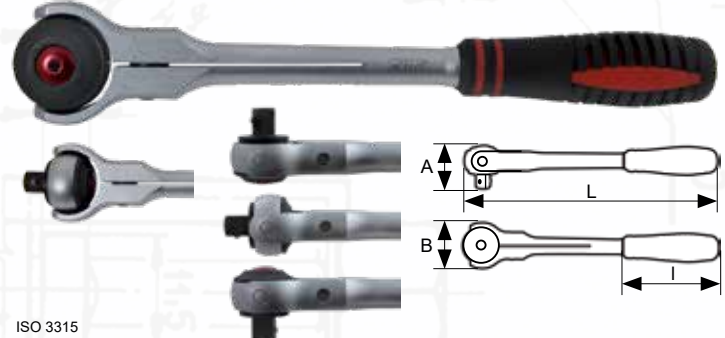

ISO 3315
DIN 3120, DIN 3122

1/4" Ráčna s výkyvnou hlavou, 72 zubů
 1/4" Ratchet with swivel head, 72 teeth
 1/4" Knarre mit schwenkbarem Kopf, 72 Zähne

kód/Code Bestellnummer	L (mm)	I (mm)	A (mm)	B (mm)	W (g)		DPC/RRP (Kč/czk)	DPC/RRP (EUR)	EAN13
4CZ-144-13	150	65	26	32	135	10	1097,52	45,73	8592667191310

Strana 15
Page 15
Seite 15

Uvedené ceny jsou DPC (doporučené prodejní ceny) v Kč a EUR bez DPH.
 All prices mentioned are DPC (RRP - recommended retail price) in CZK and EUR without VAT.
 Alle Preise sind EV-Preise (empfohlene Verkaufspreise) in CZK und EUR ohne MwSt.



i [Strana 15](#)
[Page 15](#)
[Seite 15](#)

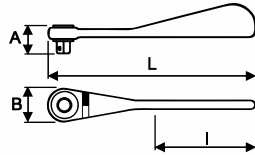

i [Strana 15](#)
[Page 15](#)
[Seite 15](#)

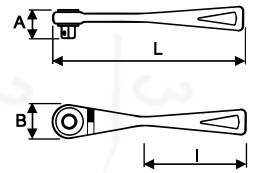

Ráčna mini přepínací s otvorem 10mm + adaptéry 1/4" NEREZ
Reverse mini ratchet with hole 10mm + adaptors 1/4" INOX
Mini-Umschaltnarre mit Loch 10mm + Adapter 1/4" EDELSTAHL

kód/Code Bestellnummer	L (mm)	A (mm)	B (mm)	W (g)	DPC/RRP (Kč/czkk)	DPC/RRP (EUR)	EAN13	
4CZ-134-10	99,2	7,9	2,4	85	50	449,59	18,73	8592667194892

Ráčna mini přepínací se čtyřhranem 1/4", kulatá rukojeť NEREZ
Reverse mini ratchet with square 1/4", round handle, INOX
Mini-Umschaltnarre mit Vierkant 1/4", runder Griff EDELSTAHL

kód/Code Bestellnummer	L (mm)	A (mm)	B (mm)	W (g)	DPC/RRP (Kč/czkk)	DPC/RRP (EUR)	EAN13	
4CZ-134-142	84,2	17,4	21,4	70	50	393,39	16,39	8592667194922



i [Strana 15](#)
[Page 15](#)
[Seite 15](#)

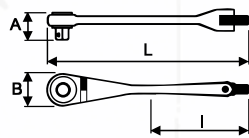

i [Strana 15](#)
[Page 15](#)
[Seite 15](#)

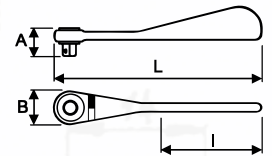

Ráčna mini přepínací s otvorem 10mm + 1/4" čtyřhranem + adaptéry 1/4" NEREZ
Reverse mini ratchet with hole 10mm + 1/4" square + adaptors 1/4" INOX
Mini-Umschaltnarre mit Loch 10mm + 1/4" Vierkant + Adapter 1/4" EDELSTAHL

kód/Code Bestellnummer	L (mm)	A (mm)	B (mm)	W (g)	DPC/RRP (Kč/czkk)	DPC/RRP (EUR)	EAN13	
4CZ-134-1014	111,7	7,9	21,4	90	50	508,26	21,18	8592667194908

Ráčna mini přepínací s otvorem 6,3mm, nízká NEREZ
Reverse mini ratchet with hole 6,3mm, low INOX
Mini-Umschaltnarre mit Loch 6,3mm, niedriger EDELSTAHL

kód/Code Bestellnummer	L (mm)	A (mm)	B (mm)	W (g)	DPC/RRP (Kč/czkk)	DPC/RRP (EUR)	EAN13	
4CZ-134-63A	98	11,1	21,4	65	50	363,64	15,15	8592667194939



i [Strana 15](#)
[Page 15](#)
[Seite 15](#)

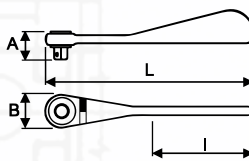

i [Strana 15](#)
[Page 15](#)
[Seite 15](#)

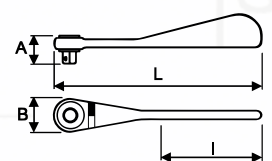

Ráčna mini přepínací se čtyřhranem 1/4" NEREZ
Reverse mini ratchet with square 1/4" INOX
Mini-Umschaltnarre mit Vierkant 1/4" EDELSTAHL

kód/Code Bestellnummer	L (mm)	A (mm)	B (mm)	W (g)	DPC/RRP (Kč/czkk)	DPC/RRP (EUR)	EAN13	
4CZ-134-14	99,6	17,5	21,4	70	50	359,50	14,98	8592667194915

Ráčna mini přepínací s otvorem 6,3mm NEREZ
Reverse mini ratchet with hole 6,3mm INOX
Mini-Umschaltnarre mit Loch 6,3mm, EDELSTAHL

kód/Code Bestellnummer	L (mm)	A (mm)	B (mm)	W (g)	DPC/RRP (Kč/czkk)	DPC/RRP (EUR)	EAN13	
4CZ-134-63B	100,2	18,5	21,4	75	50	355,37	14,81	8592667194946



4Czech®

CZECH REPUBLIC - Industry line

HLAVICE, SADY HLAVIC A RÁČNY SOCKETS, SETS OF SOCKETS AND RATCHETS STECKSCHLÜSSEL, STECKSCHLÜSSEL-SÄTZE UND KNARREN



ISO 1173 ISO 2725-1
DIN 3126 ISO 1711-2
ISO 3316 ISO 2725-2
DIN 3123 DIN 3124

4Czech ONE

1/4" Sada hlavice na liště - 4Czech ONE 5,5-6-7-8-9-10-11-12-13-14mm + kardan + adaptér na bity 1/4"
1/4" Socket set in rail - 4Czech ONE 5,5-6-7-8-9-10-11-12-13-14mm + joint + bit adapter 1/4"
1/4" Steckschlüsselsatz auf der Leiste - 4Czech One 5,5-6-7-8-9-10-11-12-13-14mm + Kardangelenken + Bitadapter 1/4"



kód/Code Bestellnummer	W (g)		DPC/RRP (Kč/czk)	DPC/RRP (EUR)	EAN13
4CZ-146-L01	226	1	664,46	27,69	8592667200685

obsah / content / Inhalt	velikost / size / Größe
1/4" hlavice 4Czech ONE / sockets 4Czech ONE / Steckschlüssel-Einsatz 4Czech ONE	5,5 - 6 - 7 - 8 - 9 - 10 - 11 - 12 - 13 - 14mm
1/4" univerzální kardan / universal joint / Universal-Kardangelenken	37mm
1/4" adaptér na bity / bit holder / Bitadapter	25mm



ISO 1173 ISO 2725-1
DIN 3126 ISO 1711-2
ISO 3316 ISO 2725-2
DIN 3123 DIN 3124

4Czech ONE

1/4" Sada hlavice prodloužených na liště - 4Czech ONE 5,5-6-7-8-9-10-11-12-13-14mm + kardan + adaptér na bity 1/4"
1/4" Deep socket set in rail - 4Czech ONE 5,5-6-7-8-9-10-11-12-13-14mm + joint + bit adapter 1/4"
1/4" Steckschlüsselsatz verlängert auf der Leiste - 4Czech One 5,5-6-7-8-9-10-11-12-13-14mm + Kardangelenken + Bitadapter 1/4"



kód/Code Bestellnummer	W (g)		DPC/RRP (Kč/czk)	DPC/RRP (EUR)	EAN13
4CZ-146-L02	380	1	846,28	35,26	8592667200692

obsah / content / Inhalt	velikost / size / Größe
1/4" Prodloužená hlavice 4Czech ONE / Long-reach socket 4Czech ONE / Steckschlüssel verlängert 4Czech ONE	5,5 - 6 - 7 - 8 - 9 - 10 - 11 - 12 - 13 - 14mm
1/4" univerzální kardan / universal joint / Universal-Kardangelenken	37mm
1/4" adaptér na bity / bit holder / Bitadapter	25mm



ISO 2725-1
ISO 1711-2
ISO 2725-2
DIN 3124

4Czech ONE

1/4" Sada hlavice na liště - 4Czech ONE 4-5-5,5-6-7-8-9-10-11-12-13-14mm
1/4" Socket set in rail - 4Czech ONE 4-5-5,5-6-7-8-9-10-11-12-13-14mm
1/4" Steckschlüsselsatz auf der Leiste - 4Czech One 4-5-5,5-6-7-8-9-10-11-12-13-14mm



kód/Code Bestellnummer	W (g)		DPC/RRP (Kč/czk)	DPC/RRP (EUR)	EAN13
4CZ-146-L06	210	1	469,42	19,56	8592667204188

obsah / content / Inhalt	velikost / size / Größe
1/4" hlavice 4Czech ONE / sockets 4Czech ONE / Steckschlüssel-Einsatz 4Czech ONE	4 - 5 - 5,5 - 6 - 7 - 8 - 9 - 10 - 11 - 12 - 13 - 14mm



ISO 2725-1
ISO 1711-2
ISO 2725-2
DIN 3124

4Czech ONE

1/4" Sada hlavice na liště - 4Czech ONE 5,5-7-8-10-13mm + Nástrčná hlavice TRX E 4-5-6-7-8-10-11
1/4" Socket set in rail - 4Czech ONE 5,5-7-8-10-13mm + Socket TORX E 4-5-6-7-8-10-11
1/4" Steckschlüsselsatz auf der Leiste - 4Czech One 5,5-7-8-10-13mm + Steckschlüssel TRX E 4-5-6-7-8-10-11



kód/Code Bestellnummer	W (g)		DPC/RRP (Kč/czk)	DPC/RRP (EUR)	EAN13
4CZ-146-L16	190	1	953,72	39,74	8592667204294

obsah / content / Inhalt	velikost / size / Größe
1/4" hlavice 4Czech ONE / sockets 4Czech ONE / Steckschlüssel-Einsatz 4Czech ONE	5,5 - 7 - 8 - 10 - 13mm
1/4" Nástrčná hlavice TRX E / Socket TORX E / Steckschlüssel TRX E	4 - 5 - 6 - 7 - 8 - 10 - 11



ISO 2725-1
ISO 1711-2
ISO 2725-2
DIN 3124

4Czech ONE

1/4" Sada hlavice prodloužených na liště - 4Czech ONE 4-5-5,5-6-7-8-9-10-11-12-13-14mm
1/4" Deep socket set in rail - 4Czech ONE 4-5-5,5-6-7-8-9-10-11-12-13-14mm
1/4" Steckschlüsselsatz verlängert auf der Leiste - 4Czech One 4-5-5,5-6-7-8-9-10-11-12-13-14mm



kód/Code Bestellnummer	W (g)		DPC/RRP (Kč/czk)	DPC/RRP (EUR)	EAN13
4CZ-146-L061	380	1	689,26	28,72	8592667204195

obsah / content / Inhalt	velikost / size / Größe
1/4" Prodloužená hlavice 4Czech ONE / Long-reach socket 4Czech ONE Steckschlüssel verlängert 4Czech ONE	4 - 5 - 5,5 - 6 - 7 - 8 - 9 - 10 - 11 - 12 - 13 - 14mm

Uvedené ceny jsou DPC (doporučené prodejní ceny) v Kč a EUR bez DPH.
All prices mentioned are DPC (RRP - recommended retail price) in CZK and EUR without VAT.
Alle Preise sind EV-Preise (empfohlene Verkaufspreise) in CZK und EUR ohne MwSt.

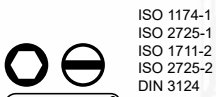

4CZech® ONE

1/4" Sada hlavice na liště - 4CZech ONE 4,5-5-5,5-6-7-8-9-10-11mm + Zástrčná hlavice plochá SL 4-5-5-7
 1/4" Socket set in rail - 4CZech ONE 4,5-5-5,5-6-7-8-9-10-11mm + Slotted bit socket SL 4-5-5-7
 1/4" Steckschlüsselsatz auf der Leiste - 4CZech One 4,5-5-5,5-6-7-8-9-10-11mm + Steckschlüssel-Einsatz Schlitz SL 4-5-5-7



kód/Code Bestellnummer	W (g)		DPC/RRP (Kč/czk)	DPC/RRP (EUR)	EAN13
4CZ-146-L07	190	1	495,04	20,63	8592667204201

obsah / content / Inhalt	velikost / size / Größe
1/4" hlavice 4CZech ONE / sockets 4CZech ONE / Steckschlüssel-Einsatz 4CZech ONE	4,5 - 5 - 5,5 - 6 - 7 - 8 - 9 - 10 - 11mm
1/4" Zástrčná hlavice plochá / Slotted bit socket / Steckschlüssel-Einsatz Schlitz	SL4 - SL5,5 - SL7

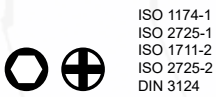

4CZech® ONE

1/4" Sada hlavice na liště - 4CZech ONE 4,5-5-5,5-6-7-8-9-10-11mm + Zástrčná hlavice phillips PH 1-2-3
 1/4" Socket set in rail - 4CZech ONE 4,5-5-5,5-6-7-8-9-10-11mm + Phillips Bit socket PH 1-2-3
 1/4" Steckschlüsselsatz auf der Leiste - 4CZech One 4,5-5-5,5-6-7-8-9-10-11mm + Steckschlüssel-Einsatz Phillips PH 1-2-3



kód/Code Bestellnummer	W (g)		DPC/RRP (Kč/czk)	DPC/RRP (EUR)	EAN13
4CZ-146-L08	190	1	495,04	20,63	8592667204218

obsah / content / Inhalt	velikost / size / Größe
1/4" hlavice 4CZech ONE / sockets 4CZech ONE / Steckschlüssel-Einsatz 4CZech ONE	4,5 - 5 - 5,5 - 6 - 7 - 8 - 9 - 10 - 11mm
1/4" Zástrčná hlavice PH / Phillips Bit socket / Steckschlüssel-Einsatz Phillips	PH1 - PH2 - PH3

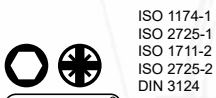

4CZech® ONE

1/4" Sada hlavice na liště - 4CZech ONE 4,5-5-5,5-6-7-8-9-10-11mm + Zástrčná hlavice pozidrive PZ 1-2-3
 1/4" Socket set in rail - 4CZech ONE 4,5-5-5,5-6-7-8-9-10-11mm + Pozidrive Bit socket PZ 1-2-3
 1/4" Steckschlüsselsatz auf der Leiste - 4CZech One 4,5-5-5,5-6-7-8-9-10-11mm + Steckschlüssel-Einsatz Pozidriv PZ 1-2-3



kód/Code Bestellnummer	W (g)		DPC/RRP (Kč/czk)	DPC/RRP (EUR)	EAN13
4CZ-146-L09	190	1	495,04	20,63	8592667204225

obsah / content / Inhalt	velikost / size / Größe
1/4" hlavice 4CZech ONE / sockets 4CZech ONE / Steckschlüssel-Einsatz 4CZech ONE	4,5 - 5 - 5,5 - 6 - 7 - 8 - 9 - 10 - 11mm
1/4" Zástrčná hlavice PZ / Pozidrive Bit socket / Steckschlüssel-Einsatz Pozidriv	PZ1 - PZ2 - PZ3

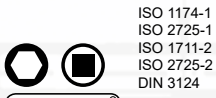

4CZech® ONE

1/4" Sada hlavice na liště - 4CZech ONE 4,5-5-5,5-6-7-8-9-10mm + Zástrčná hlavice čtyřhranná SQ 0-1-2-3
 1/4" Socket set in rail - 4CZech ONE 4,5-5-5,5-6-7-8-9-10mm + Square Bit socket SQ 0-1-2-3
 1/4" Steckschlüsselsatz auf der Leiste - 4CZech One 4,5-5-5,5-6-7-8-9-10mm + Steckschlüssel-Einsatz 4-kant SQ 0-1-2-3



kód/Code Bestellnummer	W (g)		DPC/RRP (Kč/czk)	DPC/RRP (EUR)	EAN13
4CZ-146-L10	190	1	524,79	21,87	8592667204232

obsah / content / Inhalt	velikost / size / Größe
1/4" hlavice 4CZech ONE / sockets 4CZech ONE / Steckschlüssel-Einsatz 4CZech ONE	4,5 - 5 - 5,5 - 6 - 7 - 8 - 9 - 10mm
1/4" Zástrčná hlavice čtyřhranná / Square Bit socket / Steckschlüssel-Einsatz 4-kant	SQ0 - SQ1 - SQ2 - SQ3

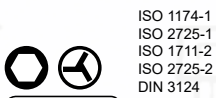

4CZech® ONE

1/4" Sada hlavice na liště - 4CZech ONE 4,5-5-5,5-6-7-8-9-10mm + Zástrčná hlavice tříkřídlová Y 1-2-3-4
 1/4" Socket set in rail - 4CZech ONE 4,5-5-5,5-6-7-8-9-10mm + Tri-Wing Bit socket Y 1-2-3-4
 1/4" Steckschlüsselsatz auf der Leiste - 4CZech One 4,5-5-5,5-6-7-8-9-10mm + Steckschlüssel-Einsatz Tri-Wing Y 1-2-3-4



kód/Code Bestellnummer	W (g)		DPC/RRP (Kč/czk)	DPC/RRP (EUR)	EAN13
4CZ-146-L11	190	1	541,32	22,56	8592667204249

obsah / content / Inhalt	velikost / size / Größe
1/4" hlavice 4CZech ONE / sockets 4CZech ONE / Steckschlüssel-Einsatz 4CZech ONE	4,5 - 5 - 5,5 - 6 - 7 - 8 - 9 - 10mm
1/4" Zástrčná hlavice tříkřídlová / Tri-Wing Bit socket / Steckschlüssel-Einsatz Tri-Wing	Y2 - Y3 - Y4 - Y5

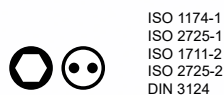

ISO 1174-1
 ISO 2725-1
 ISO 1711-2
 ISO 2725-2
 DIN 3124



1/4" Sada hlavic na liště - 4Czech ONE 4,5-5-5,5-6-7-8-9-10mm + Zástrčná hlavice klíčová U 4-6-8-10
 1/4" Socket set in rail - 4Czech ONE 4,5-5-5,5-6-7-8-9-10mm + Spanner Bit socket U 4-6-8-10
 1/4" Steckschlüsselsatz auf der Leiste - 4Czech One 4,5-5-5,5-6-7-8-9-10mm + Steckschlüssel-Einsatz U-Form U 4-6-8-10

kód/Code Bestellnummer	W (g)		DPC/RRP (Kč/czk)	DPC/RRP (EUR)	EAN13
4CZ-146-L12	190	1	524,79	21,87	8592667204256

obsah / content / Inhalt	velikost / size / Größe
1/4" hlavice 4Czech ONE / sockets 4Czech ONE / Steckschlüssel-Einsatz 4Czech ONE	4,5 - 5 - 5,5 - 6 - 7 - 8 - 9 - 10mm
1/4" Zástrčná hlavice klíčová / Spanner Bit socket / Steckschlüssel-Einsatz U-Form	U4 - U6 - U8 - U10

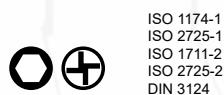

ISO 1174-1
 ISO 2725-1
 ISO 1711-2
 ISO 2725-2
 DIN 3124



1/4" Sada hlavic na liště - 4Czech ONE 5-5,5-6-7-8-9-10mm + Zástrčná hlavice čtyřkřídlová X 4-5-6-8-10
 1/4" Socket set in rail - 4Czech ONE 5-5,5-6-7-8-9-10mm + Four-Wing Bit socket X 4-5-6-8-10
 1/4" Steckschlüsselsatz auf der Leiste - 4Czech One 5-5,5-6-7-8-9-10mm + Steckschlüssel-Einsatz Four-Wing X 4-5-6-8-10

kód/Code Bestellnummer	W (g)		DPC/RRP (Kč/czk)	DPC/RRP (EUR)	EAN13
4CZ-146-L13	195	1	567,77	23,66	8592667204263

obsah / content / Inhalt	velikost / size / Größe
1/4" hlavice 4Czech ONE / sockets 4Czech ONE / Steckschlüssel-Einsatz 4Czech ONE	5 - 5,5 - 6 - 7 - 8 - 9 - 10mm
1/4" Zástrčná hlavice čtyřkřídlová / Four-Wing Bit socket / Steckschlüssel-Einsatz Four-Wing	X4 - X5 - X6 - X8 - X10



ISO 1174-1



1/4" Sada hlavic na liště - 6HR 3-4-5-6-7-8 TRX s otvorem 10-15-20-25-30-40
 1/4" Socket set in rail - HEX 3-4-5-6-7-8 TRX with hole 10-15-20-25-30-40
 1/4" Steckschlüsselsatz auf der Leiste - Imbus 3-4-5-6-7-8 TRX mit Loch 10-15-20-25-30-40

kód/Code Bestellnummer	W (g)		DPC/RRP (Kč/czk)	DPC/RRP (EUR)	EAN13
4CZ-146-L03	216	1	800,83	33,37	8592667200708

obsah / content / Inhalt	velikost / size / Größe
1/4" hlavice zástrčná imbus / HEX Bit socket / Steckschlüssel-Einsatz Imbus	H3 - H4 - H5 - H6 - H7 - H8
1/4" hlavice zástrčná TRX s otvorem / TORX Bit socket with hole / Steckschlüssel-Einsatz TRX mit Loch	TT10 - TT15 - TT20 - TT25 - TT30 - TT40



ISO 1174-1
 ISO 2725-1
 DIN 3124



1/4" Sada hlavic na liště - 6HR 2-2,5-3-4 TRX 6-7-8-9-10-15-20-25
 1/4" Socket set in rail - HEX bit socket 2-2,5-3-4 TORX 6-7-8-9-10-15-20-25
 1/4" Steckschlüsselsatz auf der Leiste - Imbus 2-2,5-3-4 TRX 6-7-8-9-10-15-20-25

kód/Code Bestellnummer	W (g)		DPC/RRP (Kč/czk)	DPC/RRP (EUR)	EAN13
4CZ-146-L14	210	1	730,58	30,44	8592667204270

obsah / content / Inhalt	velikost / size / Größe
1/4" hlavice zástrčná imbus / HEX Bit socket / Steckschlüssel-Einsatz Imbus	H2 - H2,5 - H3 - H4
1/4" hlavice zástrčná TRX / TORX Bit socket / Steckschlüssel-Einsatz TRX	T6 - T7 - T8 - T9 - T10 - T15 - T20 - T25



ISO 1174-1



1/4" Sada hlavic na liště - TRX 15-20-25-27-30-40 TRX s otvorem 15-20-25-27-30-40
 1/4" Socket set in rail - TORX 15-20-25-27-30-40 TRX with hole 15-20-25-27-30-40
 1/4" Steckschlüsselsatz auf der Leiste - TRX 15-20-25-27-30-40 TRX mit Loch 15-20-25-27-30-40

kód/Code Bestellnummer	W (g)		DPC/RRP (Kč/czk)	DPC/RRP (EUR)	EAN13
4CZ-146-L15	220	1	850,41	35,43	8592667204287

obsah / content / Inhalt	velikost / size / Größe
1/4" hlavice zástrčná TRX / TORX Bit socket / Steckschlüssel-Einsatz TRX	T15 - T20 - T25 - T27 - T30 - T40
1/4" hlavice zástrčná TRX s otvorem / TORX Bit socket with hole / Steckschlüssel-Einsatz TRX mit Loch	TT15 - TT20 - TT25 - TT27 - TT30 - TT40



ISO 2725-1
ISO 1174-1
DIN 3124

1/4" Sada hlavice zástrčných na liště - SL 4-5,5-7 PH 1-2 PZ 1-2-3 TRX 10-15-20-30

1/4" Hex socket set in rail - SL 4-5,5-7 PH 1-2 PZ 1-2-3 TRX 10-15-20-30

1/4" Steckschlüssel-Einsatz-Satz auf der Leiste - SL 4-5,5-7 PH 1-2 PZ 1-2-3 TRX 10-15-20-30

kód/Code Bestellnummer	W (g)		DPC/RRP (Kč/czk)	DPC/RRP (EUR)	EAN13
4CZ-146-L04	203	1	695,87	28,99	8592667200715

obsah / content / Inhalt	velikost / size / Größe
1/4" Zástrčná hlavice plochá / Slotted bit socket / Steckschlüssel-Einsatz Schlitz	SL4 - SL5,5 - SL7
1/4" Zástrčná hlavice PH / Phillips Bit socket / Steckschlüssel-Einsatz Phillips	PH1 - PH2
1/4" Zástrčná hlavice PZ / Pozidrive Bit socket / Steckschlüssel-Einsatz Pozidriv	PZ1 - PZ2 - PZ3
1/4" hlavice zástrčná TRX / TORX Bit socket / Steckschlüssel-Einsatz TRX	T10 - T15 - T20 - T30



ISO 2725-1
ISO 1174-1
DIN 3124

1/4" Sada hlavice zástrčných na liště - SQ 1-2-3 U 4-6-8 Y 2-3-4 X 5-6-8

1/4" Hex socket set in rail - SQ 1-2-3 U 4-6-8 Y 2-3-4 X 5-6-8

1/4" Steckschlüssel-Einsatz-Satz auf der Leiste - SQ 1-2-3 U 4-6-8 Y 2-3-4 X 5-6-8

kód/Code Bestellnummer	W (g)		DPC/RRP (Kč/czk)	DPC/RRP (EUR)	EAN13
4CZ-146-L05	226	1	720,66	30,03	8592667200722

obsah / content / Inhalt	velikost / size / Größe
1/4" Zástrčná hlavice čtyřhranná / Square Bit socket / Steckschlüssel-Einsatz 4-kant	SQ1 - SQ2 - SQ3
1/4" Zástrčná hlavice klíčová / Spanner Bit socket / Steckschlüssel-Einsatz U-Form	U4 - U6 - U8
1/4" Zástrčná hlavice tříkřídlová / Tri-Wing Bit socket / Steckschlüssel-Einsatz Tri-Wing	Y2 - Y3 - Y4
1/4" Zástrčná hlavice čtyřkřídlová / Four-Wing Bit socket / Steckschlüssel-Einsatz Four-Wing	X5 - X6 - X8



1/4" Držák hlavice - lišta 190mm pro 12 hlavice

1/4" Socket holder - rail 190mm for 12 sockets

1/4" Steckschlüsselhalter - Leiste 190mm für 12 Steckschlüssel

kód/Code Bestellnummer	S (mm)	L (mm)	A (mm)	W (g)		DPC/RRP (Kč/czk)	DPC/RRP (EUR)	EAN13
4CZ-145-90	12	190	20	29	1	51,24	2,13	8592667193277





4CZech® ONE

Rozměr / dimensions / Dimensionen:
220x110x40mm

1/4" 15dílná sada nástrčných hlavice 4-14mm + ráčna 72 zubů
 1/4" 15 pcs socket set 4-14mm + reversible ratchet 72 teeth
 1/4" 15-teiliger Steckschlüsselsatz 4-14mm + Knarre 72 Zähne

kód/Code Bestellnummer	W (g)		DPC/RRP (Kč/czk)	DPC/RRP (EUR)	EAN13
4CZ-146-15	940	10	1068,60	44,52	8592667038028

obsah / content / Inhalt	velikost / size / Größe
1/4" ráčna / ratchet / Knarre	130mm
1/4" nástavec / extension bar / Verlängerung	50, 150mm
1/4" vratidlo / sliding bar (T handle) / Gleitgriff	115mm
1/4" hlavice 4CZech ONE / sockets 4CZech ONE / Steckschlüssel-Einsatz 4CZech ONE	4,5,6,7,8,9,10,11,12,13,14mm

ISO 2725-1
 DIN 3124
 ISO 2725-2
 ISO 3315
 DIN 3122
 ISO 3120



4CZech® ONE

Rozměr / dimensions / Dimensionen:
250x130x40mm

1/4" 32-dílná sada nářadí 4-13mm + pětifunkční ráčna 72 zubů
 1/4" 32 piece socket set 4-13mm + five functional reversible ratchet 72 teeth
 1/4" 32-teiliger Steckschlüsselsatz 4-13mm + 5in1 Knarre 72 Zähne

kód/Code Bestellnummer	W (g)		DPC/RRP (Kč/czk)	DPC/RRP (EUR)	EAN13
4CZ-146-32	1480	10	1678,51	69,94	8592667042605

obsah / content / Inhalt	velikost / size / Größe
1/4" pětifunkční ráčna / 5 in 1 round reversible ratchet / 5in1 Knarre	170mm
1/4" nástavec / extension bar / Verlängerung	75, 150mm
1/4" adaptér na bity / bit holder / Bitadapter	25mm
1/4" hlavice 4CZech ONE / sockets 4CZech ONE	4,5,6,7,8,9,10,11,12,13mm
bit křížový phillips / bit phillips / Bit Phillips	PH1, PH2
bit křížový pozidrive / bit pozidrive / Bit Pozidriv	PZ1, PZ2
bit plochý / bit slotted / Bit Schlitz	SL4, SL5.5, SL6.5
bit šestihřanný imbus / bit hexagon imbus / Bit Sechskant Imbus	H3, H4, H5, H6
bit TRX / bit TORX / Bit TORX	T10, T15, T20, T25, T27, T30, T40

ISO 2725-1
 DIN 3124
 ISO 2725-2
 ISO 3315
 DIN 3122
 ISO 3120

1/4"

4CZech®

CZECH REPUBLIC - Industry Line

HLAVICE, SADY HLAVIC A RÁČNY
SOCKETS, SETS OF SOCKETS AND RATCHETS
STECKSCHLÜSSEL, STECKSCHLÜSSEL-SÄTZE UND KNARREN



4CZech ONE

Rozměr / dimensions / Dimensionen:
270x170x60mm

1/4" 42-dílná sada nářadí 4-14mm + ráčna 72 zubů
 1/4" 42 pcs socket set 4-14mm + reversible ratchet 72 teeth
 1/4" 42-teiliger Steckschlüsselsatz 4-14mm + Knarre 72 Zähne

kód/Code Bestellnummer	W (g)	DPC/RRP (Kč/czk)	DPC/RRP (EUR)	EAN13
4CZ-146-42	1440	10	2009,92	8592667036673

obsah / content / Inhalt	velikost / size / Größe
1/4" ráčna / ratchet / Knarre	130mm
1/4" nástavec / extension bar / Verlängerung	50,100,150mm
1/4" nástavec s rukojetí / Spinner Handle / Verlängerung mit Handgriff	150mm
1/4" univerzální kardan / universal joint / Universal-Kardangelenk	37mm
1/4" vratidlo / sliding bar (T handle) / Gleitgriff	115mm
1/4" adaptér na bity / bit holder / Bitadapter	25mm
1/4" hlavice 4CZech ONE / sockets 4CZech ONE / Steckschlüssel-Einsatz 4CZech ONE	4,4.5,5.5,6,7,8,9,10,11,12,13,14mm
bit křížový phillips / bit phillips / Bit Phillips	PH1, PH2, PH3
bit křížový pozidrive / bit pozidrive / Bit Pozidriv	PZ1, PZ2, PZ3
bit plochý / bit slotted / Bit Schlitz	SL4, SL5.5, SL7
bit šestihranný imbus / bit hexagon imbus / Bit Sechskant Imbus	H3, H4, H5, H6, H7, H8
bit TRX / bit TORX / Bit TORX	T10, T15, T20, T25, T30, T45

ISO 2725-1
 DIN 3124
 ISO 2725-2
 ISO 3315
 DIN 3122
 ISO 3120



Kód / Code / Bestellnummer 4CZ-38	3/8" Industry line	CrV	ISO 1174-1 ISO 1711-2 ISO 2725-1 ISO 2725-2	ISO 1173 ISO 3315 ISO 3316	DIN 3120 DIN 3122 DIN 3123 DIN 3124
---------------------------------------------	------------------------------	-----	------------------------------------------------------	----------------------------------	----------------------------------------------

POUŽITÍ	USABILITY	VERWENDUNG
----------------	------------------	-------------------

Nabízíme ucelený sortiment utahovacího nářadí. Klasické hlavice nástrčné, zástrčné, prodloužené, kardany, prodlužovací nástavce, redukce, adaptéry, sady hlavic a další příslušenství - velikosti 3/8". Speciální hlavice s patentovanou technologií 4CZech ONE pro perfektní kontakt s maticí umožňující povolit i zcela poškozené matice a zabránit jejímu poškození. Zátěžové ráčny vysoké kvality s revolučním převodem.

We offer a complete range of tightening tools. Classic hex bit and torx sockets, prolonged sockets, universal joints, extension bars, coupler adaptors, bit couplers, socket sets and other accessories - sizes 3/8". Special sockets with patented technology 4CZech ONE for perfect contact with a nut enabling to loosen even completely damaged nuts and prevent their damage. High-quality heavy-duty ratchets with the revolutionary gear.

Wir bieten eine umfassende Palette von Handwerkzeugen. Klassische-Steckschlüssel, Einsätze, verlängerte Steckschlüssel, Kardangelenke, Verlängerungen, Reduktionen, Adapter, Steckschlüsselsätze und anderes Zubehör - 3/8". Spezieller Steckschlüssel mit patentierter 4CZech-ONE-Technologie für perfekten Kontakt mit Mutter ermöglicht das Lösen auch komplett beschädigter Muttern und verhindert deren Beschädigung. Hochwertige Belastungsknarren mit revolutionärem Getriebe.

ISO 2725-1
ISO 1711-2
ISO 2725-2
DIN 3124

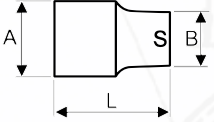

4CZech® ONE

3/8" Hlavice 4CZech ONE
3/8" Socket 4CZech ONE
3/8" Steckschlüssel 4CZech ONE

[Strana 9](#)
[Page 9](#)
[Seite 9](#)

kód/Code Bestellnummer	S (mm)	L (mm)	A (mm)	B (mm)	W (g)		DPC/RRP (Kč/czk)	DPC/RRP (EUR)	EAN13
4CZ-381-02-06	6	30	16,8	9,8	20	10	57,85	2,41	8592667038493
4CZ-381-02-07	7	30	16,8	10,7	22	10	59,50	2,48	8592667038509
4CZ-381-02-08	8	30	16,8	11,9	22	10	59,50	2,48	8592667038516
4CZ-381-02-09	9	30	16,8	13,2	23	10	59,50	2,48	8592667038523
4CZ-381-02-10	10	30	16,8	14,4	24	10	59,50	2,48	8592667038530
4CZ-381-02-11	11	30	16,8	15,7	25	10	59,50	2,48	8592667038547
4CZ-381-02-12	12	30	16,8	16,8	25	10	61,16	2,55	8592667038554
4CZ-381-02-13	13	30	16,8	17,8	27	10	61,16	2,55	8592667038561
4CZ-381-02-14	14	30	17,5	19,8	32	10	61,16	2,55	8592667038578
4CZ-381-02-15	15	30	18	20,8	34	10	61,98	2,58	8592667038585
4CZ-381-02-16	16	30	18	21,8	36	10	61,98	2,58	8592667038592
4CZ-381-02-17	17	30	19	23,9	43	10	61,98	2,58	8592667038608
4CZ-381-02-18	18	30	20	24,5	47	10	63,64	2,65	8592667038615
4CZ-381-02-19	19	30	20	25,7	50	10	63,64	2,65	8592667038622
4CZ-381-02-20	20	30	24	26,9	64	10	66,12	2,75	8592667038639
4CZ-381-02-21	21	30	24	27,9	65	10	66,94	2,79	8592667038646
4CZ-381-02-22	22	30	24	29,9	72	10	71,90	3,00	8592667038653
4CZ-381-02-23	23	30	24	30,9	77	10	119,83	4,99	8592667038660
4CZ-381-02-24	24	30	24	31,8	72	10	119,83	4,99	8592667038677



[Strana 9](#)
[Page 9](#)
[Seite 9](#)

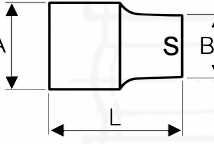

UNI
3/8" - 1/2" Hlavice univerzální
3/8" - 1/2" Universal socket
3/8" - 1/2" Universals Steckschlüssel

kód/Code Bestellnummer	S (mm)	L (mm)	A (mm)	B (mm)	W (g)		DPC/RRP (Kč/czk)	DPC/RRP (EUR)	EAN13
4CZ-381-02-UN19	7-19	52,4	25,8	26,0	130	10	427,27	17,80	8592667145771

[Informace o balení na straně 9](#)
[Packing information on page 9](#)
[Verpackungsinformationen auf Seite 9](#)



ISO 3315
DIN 3120, DIN 3122

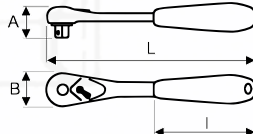

3/8" Ráčna oválná s prepínací páčkou, 72 zubů
 3/8" Reversible oval ratchet with switcher, 72 teeth
 3/8" Ovale Knarre mit Umschalthebel, 72 Zähne

kód/Code Bestellnummer	L (mm)	I (mm)	A (mm)	B (mm)	W (g)		DPC/RRP (Kč/czck)	DPC/RRP (EUR)	EAN13
4CZ-384-01	200	84	30	32	265	5	694,21	28,93	8592667040175



ISO 3315
DIN 3122

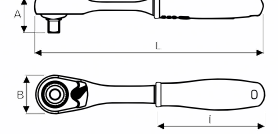

3/8" Ráčna celokovová, 72 zubů
 3/8" Small head oval full metal ratchet, 72 teeth
 3/8" Ganzstahl-Knarre, 72 Zähne

kód/Code Bestellnummer	L (mm)	I (mm)	A (mm)	B (mm)	W (g)		DPC/RRP (Kč/czck)	DPC/RRP (EUR)	EAN13
4CZ-384-10	195	95	27	26	210	10	543,80	22,66	8592667159389



ISO 3315
DIN 3120, DIN 3122

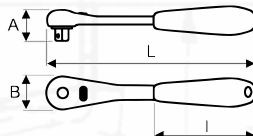

3/8" Ráčna s prepínacím tlačítkem, 72 zubů
 3/8" Reversible ratchet with switching button, 72 teeth
 3/8" Knarre mit Umschaltknopf, 72 Zähne

kód/Code Bestellnummer	L (mm)	I (mm)	A (mm)	B (mm)	W (g)		DPC/RRP (Kč/czck)	DPC/RRP (EUR)	EAN13
4CZ-384-02	200	91	30	32	297	5	694,21	28,93	8592667038684



ISO 3315
DIN 3120, DIN 3122

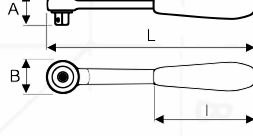

3/8" Ráčna s prepínacím kolečkem, 72 zubů
 3/8" Reversible ratchet with switching wheel, 72 teeth
 3/8" Knarre mit Umschaltrad, 72 Zähne

kód/Code Bestellnummer	L (mm)	I (mm)	A (mm)	B (mm)	W (g)		DPC/RRP (Kč/czck)	DPC/RRP (EUR)	EAN13
4CZ-384-03	200	86	33	30	219	10	528,10	22,00	8592667038691



ISO 3315
DIN 3120, DIN 3122

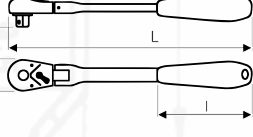

3/8" Ráčna kloubová s prepínací páčkou, 44 zubů
 3/8" Reversible hinged ratchet with switcher, 44 teeth
 3/8" Gelenknarre mit Umschalthebel, 44 Zähne

kód/Code Bestellnummer	L (mm)	I (mm)	A (mm)	B (mm)	W (g)		DPC/RRP (Kč/czck)	DPC/RRP (EUR)	EAN13
4CZ-384-04	265	87	30	32	412	10	1004,96	41,87	8592667038714



ISO 3315
DIN 3120, DIN 3122

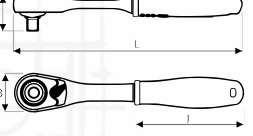

3/8" Ráčna 3D s prepínací páčkou, 30 zubů
 3/8" 3D Reversible ratchet with switcher, 30 teeth
 3/8" 3D Knarre mit Umschalthebel, 30 Zähne

kód/Code Bestellnummer	L (mm)	I (mm)	A (mm)	B (mm)	W (g)		DPC/RRP (Kč/czck)	DPC/RRP (EUR)	EAN13
4CZ-384-08	190	90	29	32	228	10	1046,28	43,60	8592667123861



ISO 3316
DIN 3123

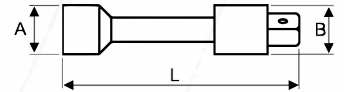

3/8" Nástavec zajišťovací
 3/8" Locking extension bar
 3/8" Schließvorrichtungen

kód/Code Bestellnummer	L (mm)	A (mm)	B (mm)	W (g)		DPC/RRP (Kč/czck)	DPC/RRP (EUR)	EAN13
4CZ-385-02-100	100	17,9	17,9	116	10	236,36	9,85	8592667038721
4CZ-385-02-275	275	17,9	17,9	275	10	307,44	12,81	8592667038738

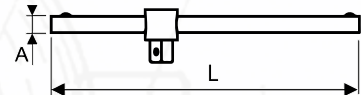

ISO 3315
DIN 3122



3/8" Vratidlo
 3/8" Sliding bar (T handle)
 3/8" Gleitgriff

kód/Code Bestellnummer	L (mm)	A (mm)	W (g)		DPC/RRP (Kč/czck)	DPC/RRP (EUR)	EAN13
4CZ-385-05-200	200	10,4	178	10,0	242,15	10,09	8592667038745

ISO 3316
DIN 3123



3/8" Univerzální kardan
 3/8" Universal Joint
 3/8" Universal-Kardangelenk

kód/Code Bestellnummer	L (mm)	I (mm)	A (mm)	W (g)		DPC/RRP (Kč/czck)	DPC/RRP (EUR)	EAN13
4CZ-385-07-51	56	45	18,8	64	10,0	221,49	9,23	8592667038769

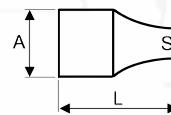

ISO 1173
DIN 3123



3/8" Adaptér na bity
 3/8" Bit holder
 3/8" Bittadapter

kód/Code Bestellnummer	S	L (mm)	A (mm)	W (g)		DPC/RRP (Kč/czck)	DPC/RRP (EUR)	EAN13
4CZ-385-11-140	1/4"	29,2	16,8	24	10	71,90	3,00	8592667038752

ISO 3316
DIN 3123



3/8" Redukce
 3/8" Coupler
 3/8" Reduktion

kód/Code Bestellnummer	S	L (mm)	A (mm)	W (g)		DPC/RRP (Kč/czck)	DPC/RRP (EUR)	EAN13
4CZ-385-01-120	1/2"	35,4	17,7	44	10	108,26	4,51	8592667038486
4CZ-385-01-140	1/4"	26,3	16,8	20	10	108,26	4,51	8592667038479

Pojistné tlačítko - na straně 15
 Safe push button - on page 15
 Sicherheitsknopf - auf Seite 15

Zajišťovací nástavce - na straně 12
 Locking extension bars - on page 12
 Verriegelbare Verlängerung - auf Seite 12

Informace o balení na straně 9
 Packing information on page 9
 Verpackungsinformationen auf Seite 9



Kód / Code / Bestellnummer
4CZ-12

1/2"

Industry line

CrV

ISO 1174
 ISO 1174-1
 ISO 1711-2
 ISO 2725-1
 ISO 2725-2

ISO 3315
 ISO 3316

DIN 3120
 DIN 3121
 DIN 3122

DIN 3123
 DIN 3124



POUŽITÍ

Nabízíme ucelený sortiment utahovacího nářadí. Klasické hlavice nástrčné, zástrčné, prodloužené, kardany, prodlužovací nástavce, redukce, vratidla, adaptéry, sady hlavice a další příslušenství - velikosti 1/2". Speciální hlavice s patentovanou technologií 4CZech ONE pro perfektní kontakt s maticí umožňující povolit i zcela poškozené matici a zabránit jejímu poškození. Zátěžové ráčny vysoké kvality s revolučním převodem.

USABILITY

We offer a complete range of tightening tools. Classic hex bit and torx sockets, prolonged sockets, universal joints, extension bars, bit couplers, adapters, sliding T handle bars, bit couplers, socket sets and other accessories - sizes 1/2". Special sockets with patented technology 4CZech ONE for perfect contact with a nut enabling to loosen even completely damaged nuts and prevent their damage. High-quality heavy-duty ratchets with the revolutionary gear.

VERWENDUNG

Wir bieten eine umfassende Palette von Handwerkzeugen. Klassische-Steckschlüssel, Einsätze, verlängerte Steckschlüssel, Kardangelenke, Verlängerungen, Reduktionen, Gleitgriffen, Adapter, Steckschlüsselsätze und anderes Zubehör - 1/2". Spezieller Steckschlüssel mit patentierter 4CZech-ONE-Technologie für perfekten Kontakt mit Mutter ermöglicht das Lösen auch komplett beschädigter Muttern und verhindert deren Beschädigung. Hochwertige Belastungsknarren mit revolutionärem Getriebe.

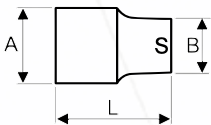

ISO 2725-1
 ISO 2725-2
 ISO 1711-2
 DIN 3124



1/2" Hlavice 4CZech ONE / * Drive
 1/2" Socket 4CZech ONE / * Drive
 1/2" Steckschlüssel 4CZech ONE / * Drive

kód/Code Bestellnummer	S (mm)	L (mm)	A (mm)	B (mm)	W (g)		DPC/RRP (Kč/czk)	DPC/RRP (EUR)	EAN13
4CZ-121-02-08	8	38	22,1	13,2	46	10	59,50	2,48	8592667036437
4CZ-121-02-09	9	38	22,1	14,2	48	10	59,50	2,48	8592667036444
4CZ-121-02-10	10	38	22,1	15,3	49	10	59,50	2,48	8592667036451
4CZ-121-02-11	11	38	22,1	16,5	51	10	59,50	2,48	8592667036468
4CZ-121-02-12	12	38	22,1	17,8	52	10	59,50	2,48	8592667036475
4CZ-121-02-13	13	38	22,1	19	54	10	59,50	2,48	8592667036482
4CZ-121-02-14	14	38	22,1	20,3	55	10	59,50	2,48	8592667036499
4CZ-121-02-15	15	38	22,1	21,5	56	10	59,50	2,48	8592667036505
4CZ-121-02-16	16	38	22,1	22,9	62	10	59,50	2,48	8592667036512
4CZ-121-02-17	17	38	22,5	24	62	10	59,50	2,48	8592667036529
4CZ-121-02-18	18	38	23	24,8	67	10	59,50	2,48	8592667036536
4CZ-121-02-19	19	38	23	26,5	74	10	60,33	2,51	8592667036543
4CZ-121-02-20	20	38	24	27,8	85	10	62,81	2,62	8592667036550
4CZ-121-02-21	21	38	24	29	87	10	62,81	2,62	8592667036567
4CZ-121-02-22	22	40	25	29,8	97	10	62,81	2,62	8592667036574
4CZ-121-02-23	23	40	26	30,8	105	10	62,81	2,62	8592667036581
4CZ-121-02-24	24	40	26	33	113	10	63,64	2,65	8592667036598
4CZ-121-02-25	25	42	27	33,5	121	10	65,29	2,72	8592667121386
4CZ-121-02-26	26	42	27	34,9	131	10	65,29	2,72	8592667036604
4CZ-121-02-27	27	45	28	36	138	10	71,90	3,00	8592667036611
4CZ-121-02-28	28	45	28	37,9	155	10	71,90	3,00	8592667036628
4CZ-121-02-29	29	45	28	39	155	10	71,90	3,00	8592667036635
4CZ-121-02-30	30	45	28	39,9	160	10	98,35	4,10	8592667036642
4CZ-121-02-32	32	45	28	41,8	166	10	98,35	4,10	8592667036659
4CZ-121-02-34	34	45	32	43,8	190	10	121,49	5,06	8592667121393
4CZ-121-02-36	36	50	36	50	345	10	344,63	14,36	8592667121409

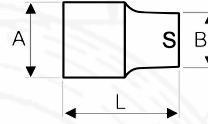

ISO 2725-1
 ISO 2725-2
 ISO 1711-2
 DIN 3124



1/2" Hlavice 4CZech ONE
 1/2" Socket 4CZech ONE
 1/2" Einsatz 4CZech ONE

kód/Code Bestellnummer	S (inch)	S (mm)	L (mm)	A (mm)	B (mm)	W (g)		DPC/RRP (Kč/czk)	DPC/RRP (EUR)	EAN13
4CZ-121-02-15/16"	5/16"	7,94	38	13,2	22,1	48	10	60,33	2,51	8592667191471
4CZ-121-02-13/8"	3/8"	9,53	38	14,7	22,1	47	10	59,50	2,48	8592667191457
4CZ-121-02-17/16"	7/16"	11,11	38	18	22,1	54	10	59,50	2,48	8592667191495
4CZ-121-02-11/2"	1/2"	12,70	38	19	22,1	55	10	60,33	2,51	8592667191372
4CZ-121-02-19/16"	9/16"	14,29	38	20,5	22,1	55	10	60,33	2,51	8592667191518
4CZ-121-02-119/32"	19/32"	15,08	38	21,5	22,1	57	10	60,33	2,51	8592667191419
4CZ-121-02-15/8"	5/8"	15,88	38	22,1	22,1	57	10	60,33	2,51	8592667191488
4CZ-121-02-121/32"	21/32"	16,67	38	23,8	22,4	62	10	60,33	2,51	8592667191426
4CZ-121-02-111/16"	11/16"	17,46	38	23,8	23	67	10	60,33	2,51	8592667191389
4CZ-121-02-13/4"	3/4"	19,05	38	26,5	23	75	10	60,33	2,51	8592667191440
4CZ-121-02-125/32"	25/32"	19,84	38	27,8	24	84	10	61,16	2,55	8592667191433
4CZ-121-02-113/16"	13/16"	20,64	38	28,9	24	90	10	61,98	2,58	8592667191396
4CZ-121-02-17/8"	7/8"	22,23	40	29,8	25	93	10	64,46	2,69	8592667191501
4CZ-121-02-115/16"	15/16"	23,81	40	32,8	26	115	10	69,42	2,89	8592667191402
4CZ-121-02-131/32"	31/32"	24,61	42	33,8	27	133	10	79,34	3,31	8592667191464
4CZ-121-02-11"	1"	25,40	42	33,8	27	129	10	79,34	3,31	8592667191365
4CZ-121-02-11/16"	1 1/16"	26,99	45	35,8	28	150	10	84,30	3,51	8592667191327
4CZ-121-02-11/8"	1 1/8"	28,58	45	38,9	28	162	10	91,74	3,82	8592667191341
4CZ-121-02-11 3/16"	1 3/16"	30,16	45	39,8	28	168	10	101,65	4,24	8592667191358
4CZ-121-02-11 1/4"	1 1/4"	31,75	45	41,9	28	170	10	111,57	4,65	8592667191334

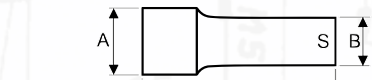

ISO 2725-1
 ISO 2725-2
 ISO 1711-2
 DIN 3124



1/2" Prodloužená hlavice 4CZech ONE
 1/2" Long-reach socket 4CZech ONE
 1/2" Steckschlüssel verlängert 4CZech ONE

kód/Code Bestellnummer	S (mm)	L (mm)	A (mm)	B (mm)	W (g)		DPC/RRP (Kč/czk)	DPC/RRP (EUR)	EAN13
4CZ-121-03-08	8	76,4	22	15	70	10	152,89	6,37	8592667124424
4CZ-121-03-10	10	76,4	22	15,3	79	10	152,89	6,37	8592667036680
4CZ-121-03-12	12	76,4	22	17,8	93	10	152,89	6,37	8592667036697
4CZ-121-03-13	13	76,4	22	19	102	10	152,89	6,37	8592667036703
4CZ-121-03-14	14	76,4	22	20,3	106	10	152,89	6,37	8592667036710
4CZ-121-03-15	15	76,4	22	21,3	112	10	160,33	6,68	8592667036727
4CZ-121-03-16	16	76,4	22	22	108	10	160,33	6,68	8592667036734
4CZ-121-03-17	17	76,4	22,5	23,8	129	10	160,33	6,68	8592667036741
4CZ-121-03-18	18	76,4	23	25,9	156	10	160,33	6,68	8592667036758
4CZ-121-03-19	19	76,4	23	25,9	144	10	160,33	6,68	8592667036765
4CZ-121-03-21	21	76,4	24	28	164	10	160,33	6,68	8592667036772
4CZ-121-03-22	22	76,4	25	30	198	10	170,25	7,09	8592667036789
4CZ-121-03-24	24	76,4	26	31,8	216	10	170,25	7,09	8592667036796
4CZ-121-03-27	27	76,4	28	35,9	285	10	175,21	7,30	8592667036802
4CZ-121-03-30	30	76,4	28	39,9	338	10	190,91	7,95	8592667036819

[Informace o balení na straně 9](#)
[Packing information on page 9](#)
[Verpackungsinformationen auf Seite 9](#)

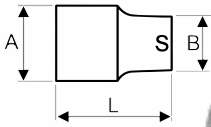

ISO 2725
DIN 3124



1/2" Hlavice 12-ti hranná
1/2" Socket Bi-hexagonal
1/2" Steckschlüssel 12-kant

[Strana 9](#)
[Page 9](#)
[Seite 9](#)

kód/Code Bestellnummer	S (mm)	L (mm)	A (mm)	B (mm)	W (g)		DPC/RRP (Kč/czk)	DPC/RRP (EUR)	EAN13
4CZ-121-04-08	8	38	22	13	45	10	59,50	2,48	8592667159396
4CZ-121-04-09	9	38	22	14	44	10	59,50	2,48	8592667159402
4CZ-121-04-10	10	38	22	15	48	10	59,50	2,48	8592667159419
4CZ-121-04-11	11	38	22	16	48	10	59,50	2,48	8592667159426
4CZ-121-04-12	12	38	22	17	50	10	59,50	2,48	8592667159433
4CZ-121-04-13	13	38	22	19	52	10	59,50	2,48	8592667159440
4CZ-121-04-14	14	38	22	20	54	10	59,50	2,48	8592667159457
4CZ-121-04-15	15	38	22	21	54	10	59,50	2,48	8592667159464
4CZ-121-04-16	16	38	22	23	61	10	59,50	2,48	8592667159471
4CZ-121-04-17	17	38	22	24	61	10	59,50	2,48	8592667159488
4CZ-121-04-18	18	38	22	25	69	10	59,50	2,48	8592667159495
4CZ-121-04-19	19	38	22	26	74	10	61,16	2,55	8592667159501
4CZ-121-04-20	20	38	24	27	79	10	62,81	2,62	8592667159518
4CZ-121-04-21	21	38	24	29	83	10	62,81	2,62	8592667159525
4CZ-121-04-22	22	39	25	29	90	10	62,81	2,62	8592667159532
4CZ-121-04-23	23	40	26	31	99	10	62,81	2,62	8592667159549
4CZ-121-04-24	24	40	26	32	111	10	63,64	2,65	8592667159556
4CZ-121-04-25	25	42	26	33	113	10	66,12	2,75	8592667159563
4CZ-121-04-26	26	42	27	35	134	10	65,29	2,72	8592667159570
4CZ-121-04-27	27	45	27	35	142	10	71,90	3,00	8592667159587
4CZ-121-04-28	28	45	27	37	157	10	71,90	3,00	8592667159594
4CZ-121-04-29	29	45	27	38	160	10	71,90	3,00	8592667159600
4CZ-121-04-30	30	45	28	39	154	10	98,35	4,10	8592667159617
4CZ-121-04-32	32	45	28	42	150	10	98,35	4,10	8592667159624
4CZ-121-04-36	36	50	35	49	300	10	344,63	14,36	8592667159631

ISO 1174-1

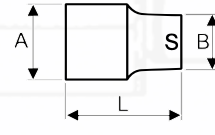

1/2" Nástrčná hlavice TRX
1/2" Socket TORX
1/2" Steckschlüssel TRX

[Strana 9](#)
[Page 9](#)
[Seite 9](#)

kód/Code Bestellnummer	S	L	A	B	W		DPC/RRP (Kč/czk)	DPC/RRP (EUR)	EAN13
4CZ-123-07-08	E 8	38	23,9	11	52	10	189,26	7,89	8592667037274
4CZ-123-07-10	E 10	38	23,9	12,5	56	10	190,91	7,95	8592667037281
4CZ-123-07-11	E 11	38	23,9	14	56	10	190,91	7,95	8592667037298
4CZ-123-07-12	E 12	38	23,9	15	58	10	190,91	7,95	8592667037304
4CZ-123-07-14	E 14	38	23,9	17	60	10	190,91	7,95	8592667037311
4CZ-123-07-16	E 16	38	23,9	19	63	10	190,91	7,95	8592667037328
4CZ-123-07-18	E 18	38	23,9	21	68	10	196,69	8,20	8592667037335
4CZ-123-07-20	E 20	38	23,9	23,5	72	10	196,69	8,20	8592667037342
4CZ-123-07-22	E 22	38	23,9	26	85	10	211,57	8,82	8592667037359
4CZ-123-07-24	E 24	38	23,9	28	98	10	230,58	9,61	8592667037366

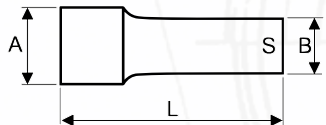

ISO 2725-1
DIN 3124



1/2" Prodloužená hlavice 12-ti hranná
1/2" Long-reach socket Bi-hexagonal
1/2" Steckschlüssel verlängert 12-kant

[Strana 9](#)
[Page 9](#)
[Seite 9](#)

kód/Code Bestellnummer	S (mm)	L (mm)	A (mm)	B (mm)	W (g)		DPC/RRP (Kč/czk)	DPC/RRP (EUR)	EAN13
4CZ-121-05-08	8	76	22	13	73	10	161,98	6,75	8592667159648
4CZ-121-05-09	9	76	22	14	94	10	161,98	6,75	8592667159655
4CZ-121-05-10	10	76	22	15	82	10	152,89	6,37	8592667159662
4CZ-121-05-11	11	76	22	16	84	10	152,89	6,37	8592667159679
4CZ-121-05-12	12	76	22	17	91	10	152,89	6,37	8592667159686
4CZ-121-05-13	13	76	22	18	99	10	152,89	6,37	8592667159693
4CZ-121-05-14	14	76	22	20	104	10	152,89	6,37	8592667159709
4CZ-121-05-15	15	76	22	22	110	10	160,33	6,68	8592667159716
4CZ-121-05-16	16	76	22	22	104	10	160,33	6,68	8592667159723
4CZ-121-05-17	17	76	22	24	127	10	160,33	6,68	8592667159730
4CZ-121-05-18	18	76	23	26	154	10	160,33	6,68	8592667159747
4CZ-121-05-19	19	76	23	26	137	10	160,33	6,68	8592667159754
4CZ-121-05-20	20	76	24	28	167	10	159,50	6,65	8592667159761
4CZ-121-05-21	21	76	24	28	150	10	160,33	6,68	8592667159778
4CZ-121-05-22	22	76	25	30	186	10	170,25	7,09	8592667159785
4CZ-121-05-23	23	76	26	32	222	10	170,25	7,09	8592667159792
4CZ-121-05-24	24	76	26	32	203	10	170,25	7,09	8592667159808
4CZ-121-05-25	25	76	27	33	224	10	173,55	7,23	8592667159815
4CZ-121-05-26	26	76	27	36	285	10	173,55	7,23	8592667159822
4CZ-121-05-27	27	76	27	36	270	10	175,21	7,30	8592667159839
4CZ-121-05-28	28	76	28	38	308	10	190,08	7,92	8592667159846
4CZ-121-05-29	29	76	28	39	265	10	190,08	7,92	8592667159853
4CZ-121-05-30	30	76	28	40	327	10	190,91	7,95	8592667159860
4CZ-121-05-32	32	76	28	42	350	10	195,04	8,13	8592667159877

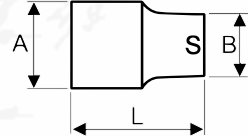

1/2" Hlavice univerzální
1/2" Universal socket
1/2" Universal Steckschlüssel

[Strana 9](#)
[Page 9](#)
[Seite 9](#)

kód/Code Bestellnummer	S (mm)	L (mm)	A (mm)	B (mm)	W (g)		DPC/RRP (Kč/czk)	DPC/RRP (EUR)	EAN13
4CZ-121-02-UN27	9-27	68	36	33	320	10	597,52	24,90	8592667145757
4CZ-121-02-UN32	10-32	74	43	39	510	10	714,88	29,79	8592667145764

[Informace o balení na straně 9](#)
[Packing information on page 9](#)
[Verpackungsinformationen auf Seite 9](#)

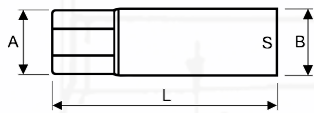

DIN 3121



ISO 1173
DIN 3126

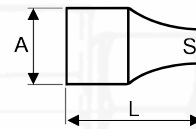

1/2" Adaptér na bity
1/2" Bit holder
1/2" Bittadapter

[Strana 9](#)
[Page 9](#)
[Seite 9](#)

kód/Code Bestellnummer	S	L (mm)	A (mm)	W (g)		DPC/RRP (Kč/czk)	DPC/RRP (EUR)	EAN13
4CZ-125-11-10	10mm	37,8	21,8	50	10	164,46	6,85	8592667124417
4CZ-125-11-516	5/16"	37,8	21,8	48	10	164,46	6,85	8592667037472



1/2" Hlavice na svíčky
1/2" Spark plug
1/2" Steckschlüssel für Zündkerzen

[Strana 9](#)
[Page 9](#)
[Seite 9](#)

kód/Code Bestellnummer	S (mm)	L (mm)	A (mm)	B (mm)	W (g)		DPC/RRP (Kč/czk)	DPC/RRP (EUR)	EAN13
4CZ-121-01-16S	16	64,5	21,7	21,7	90	10	211,57	8,82	8592667138629
4CZ-121-01-21S	21	64,5	23,5	27,6	140	10	211,57	8,82	8592667138636

ISO 3316
DIN 3123

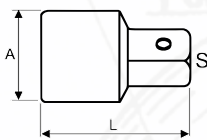

1/2" Redukce
1/2" Coupler
1/2" Reduktion

[Strana 9](#)
[Page 9](#)
[Seite 9](#)

kód/Code Bestellnummer	S	L (mm)	A (mm)	W (g)		DPC/RRP (Kč/czk)	DPC/RRP (EUR)	EAN13
4CZ-125-01-340	3/4"	45	26	120	10	216,53	9,02	8592667036420
4CZ-125-01-380	3/8"	36	21,8	50	10	109,92	4,58	8592667036413

ISO 3316
DIN 3123

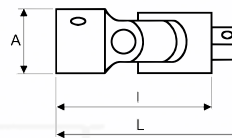

1/2" Univerzální kardan
1/2" Universal Joint
1/2" Universal-Kardangelen

[Strana 9](#)
[Page 9](#)
[Seite 9](#)

kód/Code Bestellnummer	L (mm)	I (mm)	A (mm)	W (g)		DPC/RRP (Kč/czk)	DPC/RRP (EUR)	EAN13
4CZ-125-07-70	77	62	24,9	162	10	307,44	12,81	8592667037489

[Informace o balení na straně 9](#)
[Packing information on page 9](#)
[Verpackungsinformationen auf Seite 9](#)

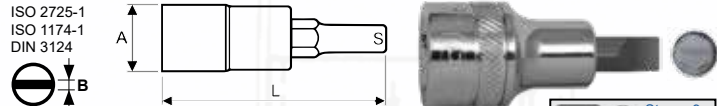

ISO 2725-1
ISO 1174-1
DIN 3124
1/2" Zástrčná hlavice plochá
1/2" Slotted bit socket
1/2" Steckschlüssel-Einsatz Schlitz

kód/Code Bestellnummer	S	B	L (mm)	A (mm)	W (g)		DPC/RRP (Kč/czk)	DPC/RRP (EUR)	EAN13
4CZ-122-10-055	SL5,5	1	55	23,9	72	10	80,17	3,34	8592667042377
4CZ-122-10-08	SL8	1,2	55	23,9	75	10	80,17	3,34	8592667042384
4CZ-122-10-10	SL10	1,6	55	23,9	86	10	84,30	3,51	8592667042391
4CZ-122-10-12	SL12	2	55	23,9	89	10	93,39	3,89	8592667042407
4CZ-122-10-14	SL14	2,5	55	23,9	103	10	109,09	4,55	8592667042414
4CZ-122-10-16	SL16	3	55	23,9	105	10	118,18	4,92	8592667042421

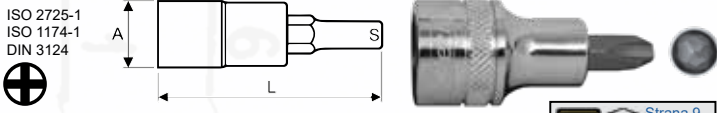

ISO 2725-1
ISO 1174-1
DIN 3124
1/2" Zástrčná hlavice phillips
1/2" PH Bit socket
1/2" Steckschlüssel-Einsatz Phillips

kód/Code Bestellnummer	S	L (mm)	A (mm)	W (g)		DPC/RRP (Kč/czk)	DPC/RRP (EUR)	EAN13
4CZ-122-09-01	PH1	55	23,9	73	10	80,17	3,34	8592667042339
4CZ-122-09-02	PH2	55	23,9	74	10	80,17	3,34	8592667042346
4CZ-122-09-03	PH3	55	23,9	74	10	80,17	3,34	8592667042353
4CZ-122-09-04	PH4	55	23,9	75	10	80,99	3,37	8592667042360

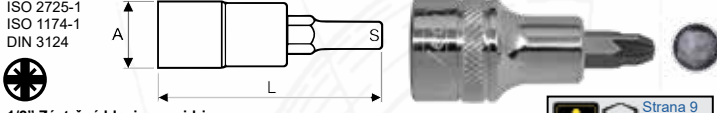

ISO 2725-1
ISO 1174-1
DIN 3124
1/2" Zástrčná hlavice pozidrive
1/2" PZ Bit socket
1/2" Steckschlüssel-Einsatz Pozidriv

kód/Code Bestellnummer	S	L (mm)	A (mm)	W (g)		DPC/RRP (Kč/czk)	DPC/RRP (EUR)	EAN13
4CZ-122-08-01	PZ1	55	23,9	72	10	80,17	3,34	8592667042292
4CZ-122-08-02	PZ2	55	23,9	72	10	80,17	3,34	8592667042308
4CZ-122-08-03	PZ3	55	23,9	74	10	80,17	3,34	8592667042315
4CZ-122-08-04	PZ4	55	23,9	75	10	80,99	3,37	8592667042322

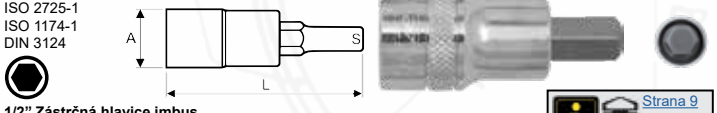

ISO 2725-1
ISO 1174-1
DIN 3124
1/2" Zástrčná hlavice imbus
1/2" HEX Bit socket
1/2" Steckschlüssel-Einsatz imbus

kód/Code Bestellnummer	S (mm)	L (mm)	A (mm)	W (g)		DPC/RRP (Kč/czk)	DPC/RRP (EUR)	EAN13
4CZ-122-01-04	H4	55	23,9	73	10	90,91	3,79	8592667121416
4CZ-122-01-05	H5	55	23,9	73	10	99,17	4,13	8592667036826
4CZ-122-01-06	H6	55	23,9	75	10	99,17	4,13	8592667036833
4CZ-122-01-07	H7	55	23,9	76	10	102,48	4,27	8592667036840
4CZ-122-01-08	H8	55	23,9	78	10	102,48	4,27	8592667036857
4CZ-122-01-09	H9	55	23,9	88	10	108,26	4,51	8592667121423
4CZ-122-01-10	H10	55	23,9	90	10	108,26	4,51	8592667036864
4CZ-122-01-12	H12	55	23,9	94	10	118,18	4,92	8592667036871
4CZ-122-01-14	H14	55	23,9	112	10	190,91	7,95	8592667036888
4CZ-122-01-17	H17	55	27,9	175	10	205,79	8,57	8592667036895
4CZ-122-01-19	H19	55	32,2	234	10	219,01	9,13	8592667036901

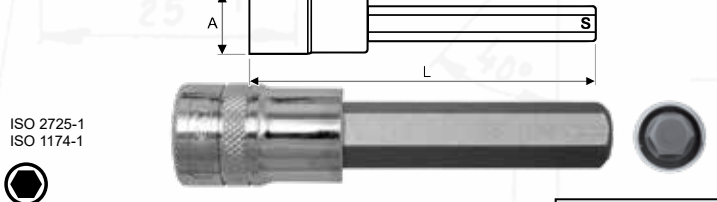

ISO 2725-1
ISO 1174-1
1/2" Zástrčná hlavice imbus prodloužená
1/2" HEX Bit socket long-reach type
1/2" Steckschlüssel-Einsatz imbus verlängert

kód/Code Bestellnummer	S (mm)	L (mm)	A (mm)	W (g)		DPC/RRP (Kč/czk)	DPC/RRP (EUR)	EAN13
4CZ-122-03-04	H4	100	23,9	93	10	123,97	5,17	8592667121430
4CZ-122-03-05	H5	100	23,9	93	10	123,97	5,17	8592667036918
4CZ-122-03-06	H6	100	23,9	95	10	123,97	5,17	8592667036925
4CZ-122-03-07	H7	100	23,9	95	10	130,58	5,44	8592667036932
4CZ-122-03-08	H8	100	23,9	96	10	130,58	5,44	8592667036949
4CZ-122-03-10	H10	100	23,9	120	10	130,58	5,44	8592667036956
4CZ-122-03-12	H12	100	23,9	138	10	138,84	5,79	8592667036963
4CZ-122-03-14	H14	100	23,9	172	10	184,30	7,68	8592667036970

[Informace o balení na straně 9](#)
[Packing information on page 9](#)
[Verpackungsinformationen auf Seite 9](#)

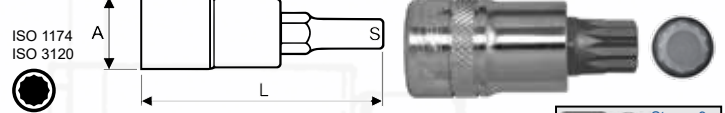

ISO 1174
ISO 3120
1/2" Zástrčná hlavice XZN
1/2" XZN Bit socket
1/2" Steckschlüssel-Einsatz XZN

kód/Code Bestellnummer	S	L (mm)	A (mm)	W (g)		DPC/RRP (Kč/czk)	DPC/RRP (EUR)	EAN13
4CZ-122-11-05	M 5	55	23,9	73	10	93,39	3,89	8592667037168
4CZ-122-11-06	M 6	55	23,9	75	10	93,39	3,89	8592667037175
4CZ-122-11-08	M 8	55	23,9	76	10	99,17	4,13	8592667037182
4CZ-122-11-10	M 10	55	23,9	89	10	108,26	4,51	8592667037199
4CZ-122-11-12	M 12	55	23,9	91	10	130,58	5,44	8592667037205
4CZ-122-11-14	M 14	55	23,9	106	10	158,68	6,61	8592667037212
4CZ-122-11-16	M 16	55	23,9	114	10	170,25	7,09	8592667037229

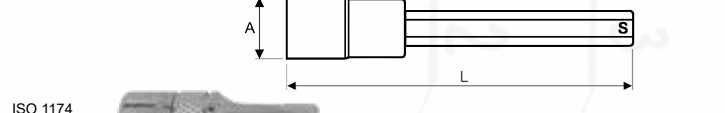

ISO 1174
ISO 3120
1/2" Zástrčná hlavice XZN prodloužená
1/2" XZN Bit socket long-reach type
1/2" Steckschlüssel-Einsatz XZN verlängert

kód/Code Bestellnummer	S	L (mm)	A (mm)	W (g)		DPC/RRP (Kč/czk)	DPC/RRP (EUR)	EAN13
4CZ-122-12-08	M 8	100	23,9	93	10	175,21	7,30	8592667037236
4CZ-122-12-10	M 10	100	23,9	118	10	175,21	7,30	8592667037243
4CZ-122-12-12	M 12	100	23,9	127	10	227,27	9,47	8592667037250
4CZ-122-12-14	M 14	100	23,9	165	10	225,62	9,40	8592667037267

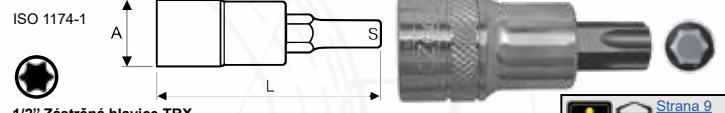

ISO 1174-1
1/2" Zástrčná hlavice TRX
1/2" TORX Bit socket
1/2" Steckschlüssel-Einsatz TRX

kód/Code Bestellnummer	S	L (mm)	A (mm)	W (g)		DPC/RRP (Kč/czk)	DPC/RRP (EUR)	EAN13
4CZ-122-04-20	T20	55	23,9	72	10	102,48	4,27	8592667121447
4CZ-122-04-25	T25	55	23,9	72	10	102,48	4,27	8592667121454
4CZ-122-04-27	T27	55	23,9	73	10	102,48	4,27	8592667036987
4CZ-122-04-30	T30	55	23,9	74	10	102,48	4,27	8592667036994
4CZ-122-04-40	T40	55	23,9	85	10	102,48	4,27	8592667037007
4CZ-122-04-45	T45	55	23,9	86	10	123,97	5,17	8592667121461
4CZ-122-04-50	T50	55	23,9	86	10	123,97	5,17	8592667121478
4CZ-122-04-55	T55	55	23,9	89	10	170,25	7,09	8592667037014
4CZ-122-04-60	T60	55	23,9	92	10	180,17	7,51	8592667037021



ISO 1174-1
1/2" Zástrčná hlavice TRX prodloužená
1/2" TORX Bit socket long-reach type
1/2" Steckschlüssel-Einsatz TRX verlängert

kód/Code Bestellnummer	S	L (mm)	A (mm)	W (g)		DPC/RRP (Kč/czk)	DPC/RRP (EUR)	EAN13
4CZ-122-05-30	T30	100	23,9	91	10	160,33	6,68	8592667191945
4CZ-122-05-40	T40	100	23,9	115	10	160,33	6,68	8592667037038
4CZ-122-05-45	T45	100	23,9	117	10	160,33	6,68	8592667037045
4CZ-122-05-50	T50	100	23,9	117	10	180,17	7,51	8592667037052
4CZ-122-05-55	T55	100	23,9	120	10	205,79	8,57	8592667037069

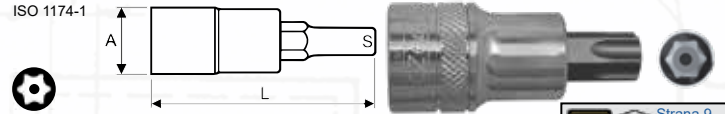

ISO 1174-1
1/2" Zástrčná hlavice TRX s otvorem
1/2" TORX Bit socket with hole
1/2" Steckschlüssel-Einsatz TRX mit Loch

kód/Code Bestellnummer	S	L (mm)	A (mm)	W (g)		DPC/RRP (Kč/czk)	DPC/RRP (EUR)	EAN13
4CZ-122-06-20	TT20	55	23,9	72	10	102,48	4,27	8592667037076
4CZ-122-06-25	TT25	55	23,9	73	10	102,48	4,27	8592667037083
4CZ-122-06-27	TT27	55	23,9	73	10	102,48	4,27	8592667037090
4CZ-122-06-30	TT30	55	23,9	73	10	102,48	4,27	8592667037106
4CZ-122-06-40	TT40	55	23,9	84	10	102,48	4,27	8592667037113
4CZ-122-06-45	TT45	55	23,9	85	10	123,97	5,17	8592667037120
4CZ-122-06-50	TT50	55	23,9	86	10	123,97	5,17	8592667037137
4CZ-122-06-55	TT55	55	23,9	89	10	170,25	7,09	8592667037144
4CZ-122-06-60	TT60	55	23,9	91	10	180,17	7,51	8592667037151



ISO 3315
DIN 3120, DIN 3122

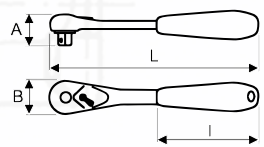

1/2" Ráčna oválná s prepínací páčkou, 60 zubů
 1/2" Reversible oval ratchet with switcher, 60 teeth
 1/2" Ovale Knarre mit Umschalthebel, 60 Zähne

kód/Code Bestellnummer	L (mm)	I (mm)	A (mm)	B (mm)	W (g)		DPC/RRP (Kč/cz)	DPC/RRP (EUR)	EAN13
4CZ-124-01	257	109	37	41	568	3	774,38	32,27	8592667040144



ISO 3315
DIN 3120, DIN 3122

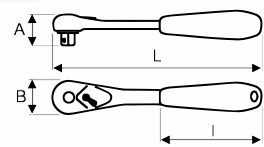

1/2" Ráčna s prepínacím kolečkem, 48 zubů
 1/2" Reversible ratchet with flex head, 48 teeth
 1/2" Knarre mit Umschaltrad, 48 Zähne

kód/Code Bestellnummer	L (mm)	I (mm)	A (mm)	B (mm)	W (g)		DPC/RRP (Kč/cz)	DPC/RRP (EUR)	EAN13
4CZ-124-07	257	105	38	42	530	5	774,38	32,27	8592667109896



ISO 3315
DIN 3120, DIN 3122

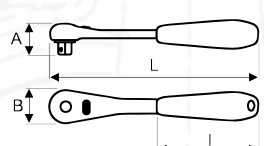

1/2" Ráčna s prepínacím tlačítkem, 72 zubů
 1/2" Reversible ratchet with switching button, 72 teeth
 1/2" Knarre mit Umschaltnopf, 72 Zähne

kód/Code Bestellnummer	L (mm)	I (mm)	A (mm)	B (mm)	W (g)		DPC/RRP (Kč/cz)	DPC/RRP (EUR)	EAN13
4CZ-124-02	250	115	37	41	496	3	774,38	32,27	8592667037373



ISO 3315
DIN 3120, DIN 3122

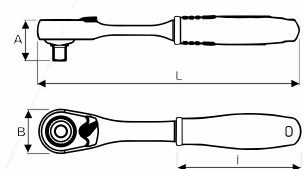

1/2" Ráčna 3D s prepínací páčkou, 30 zubů
 1/2" 3D Reversible ratchet with switcher, 30 teeth
 1/2" 3D Knarre mit Umschalthebel, 30 Zähne

kód/Code Bestellnummer	L (mm)	I (mm)	A (mm)	B (mm)	W (g)		DPC/RRP (Kč/cz)	DPC/RRP (EUR)	EAN13
4CZ-124-08	250	110	44	39	442	10	1175,21	48,97	8592667123854



ISO 3315
DIN 3120, DIN 3122

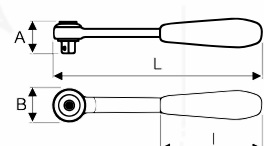
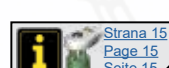

1/2" Ráčna s prepínacím kolečkem, 72 zubů
 1/2" Reversible ratchet with switching wheel, 72 teeth
 1/2" Knarre mit Umschaltrad, 72 Zähne

kód/Code Bestellnummer	L (mm)	I (mm)	A (mm)	B (mm)	W (g)		DPC/RRP (Kč/cz)	DPC/RRP (EUR)	EAN13
4CZ-124-03	250	107	45	38	475	5	589,26	24,55	8592667037380



ISO 3315
DIN 3120, DIN 3122

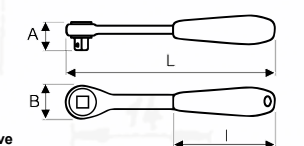

1/2" Ráčna přesuvná, 270mm, 30 zubů, bez čtyřhranu
 1/2" Push-Thru Ratchet, 270mm 30 teeth, without square drive
 1/2" Durchsteckknarre, 30 Zähne, ohne Verbindungsvierkant

kód/Code Bestellnummer	L (mm)	I (mm)	A (mm)	B (mm)	W (g)		DPC/RRP (Kč/cz)	DPC/RRP (EUR)	EAN13
4CZ-124-09	270	109	-	43	519	10	849,59	35,40	8592667123977



ISO 3315
DIN 3120, DIN 3122

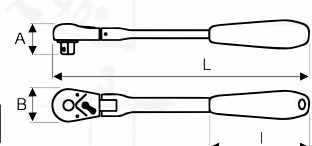

1/2" Ráčna s prepínacím kolečkem, 44 zubů
 1/2" Reversible ratchet with flex head, 44 teeth
 1/2" Gelenk-Knarre mit Umschalthebel, 44 Zähne

kód/Code Bestellnummer	L (mm)	I (mm)	A (mm)	B (mm)	W (g)		DPC/RRP (Kč/cz)	DPC/RRP (EUR)	EAN13
4CZ-124-04	300	111	37	43	738	5	1132,23	47,18	8592667037403

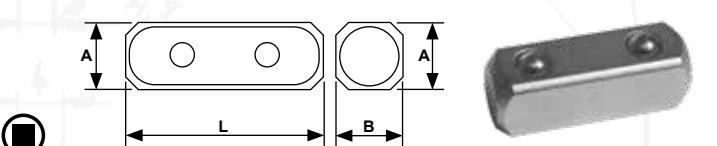

Čtyřhran do přesuvné ráčny 1/2"
 Square to Push-Thru ratchet 1/2"
 1/2" Verbindungsvierkant für Durchsteckknarre 1/2"

kód/Code Bestellnummer	L (mm)	A (mm)	B (mm)	W (g)		DPC/RRP (Kč/cz)	DPC/RRP (EUR)	EAN13
4CZ-124-09-NN	38	13	13	10	10	164,46	6,85	8592667123984

Pojistné tlačítko - na straně 15
 Safe push button - on page 15
 Sicherheitsknopf - auf Seite 15



Strana 15
Page 15
Seite 15

ISO 3315
DIN 3122

1/2" Ráčna celokovová, 72 zubů
1/2" Small head oval full metal ratchet, 72 teeth
1/2" Ganzstahl-Knarre, 72 Zähne

kód/Code Bestellnummer	L (mm)	I (mm)	A (mm)	B (mm)	W (g)		DPC/RRP (Kč/czk)	DPC/RRP (EUR)	EAN13
4CZ-124-10	244	115	36	31	382	5	585,12	24,38	8592667159365

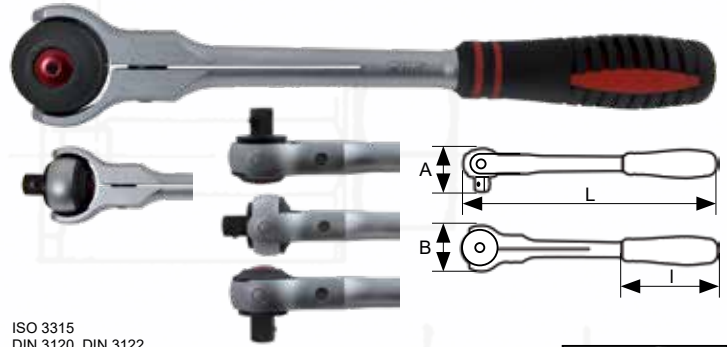
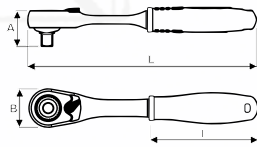

ISO 3315
DIN 3120, DIN 3122

1/2" Ráčna s výkyvnou hlavou, 72 zubů
1/2" Ratchet with swivel head, 72 teeth
1/2" Knarre mit schwenkbarem Kopf, 72 Zähne

kód/Code Bestellnummer	L (mm)	I (mm)	A (mm)	B (mm)	W (g)		DPC/RRP (Kč/czk)	DPC/RRP (EUR)	EAN13
4CZ-124-13	280	106	44	48	645	5	1420,66	59,19	8592667191303



Strana 15
Page 15
Seite 15

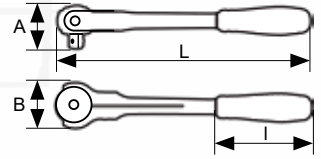

ISO 3315
DIN 3120, DIN 3122

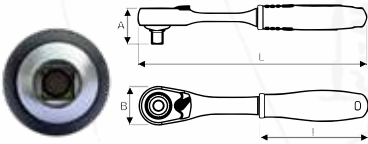

1/2" Ráčna rotační, 52 zubů
1/2" Rotary ratchet, 52 teeth
1/2" Rotationsknarre, 52 Zähne

kód/Code Bestellnummer	L (mm)	I (mm)	A (mm)	B (mm)	W (g)		DPC/RRP (Kč/czk)	DPC/RRP (EUR)	EAN13
4CZ-124-11	292	140	44	43	729	5	1859,50	77,48	8592667173415



Strana 15
Page 15
Seite 15

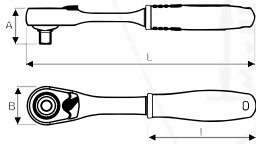

1/2" Vratidlo zajišťovací
1/2" Sliding bar (T handle)
1/2" Gleitgriff

kód/Code Bestellnummer	L (mm)	A (mm)	W (g)		DPC/RRP (Kč/czk)	DPC/RRP (EUR)	EAN13
4CZ-125-05-300	300	13,3	401	10	322,31	13,43	8592667037441

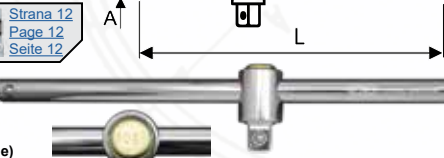

ISO 3315
DIN 3122

ISO 3316
DIN 3123

1/2" Nástavec zajišťovací
1/2" Locking extension bar
1/2" Verriegelbare Verlängerung

kód/Code Bestellnummer	L (mm)	A (mm)	B (mm)	W (g)		DPC/RRP (Kč/czk)	DPC/RRP (EUR)	EAN13
4CZ-125-02-105	105	23,9	22	212	10	230,58	9,61	8592667037410
4CZ-125-02-155	155	23,9	22	299	10	241,32	10,06	8592667037427
4CZ-125-02-280	280	23,9	22	506	10	307,44	12,81	8592667037434



Strana 12
Page 12
Seite 12



Strana 9
Page 9
Seite 9

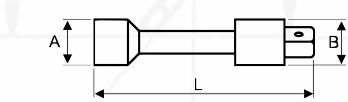

ISO 3316
DIN 3123

1/2" Nástavec pružinový
1/2" Flexible Extension Bar
1/2" Flexible Verlängerung

kód/Code Bestellnummer	L (mm)	A (mm)	W (g)		DPC/RRP (Kč/czk)	DPC/RRP (EUR)	EAN13
4CZ-125-03-200	200	23,9	130	10	550,41	22,93	8592667138643



Strana 9
Page 9
Seite 9

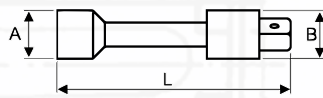

ISO 1174
DIN 3122

1/2" Ohnutá rukojeť
1/2" Angle bar, square drive
1/2" Gebogener Handgriff

kód/Code Bestellnummer	L (mm)	A (mm)	W (g)		DPC/RRP (Kč/czk)	DPC/RRP (EUR)	EAN13
4CZ-125-08-200	200	16,2	370	10	246,28	10,26	8592667037496
4CZ-125-09-300	300	16,2	532	10	450,41	18,77	8592667037502

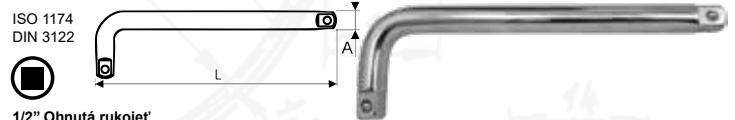

ISO 3315
ISO 1174-1
DIN 3122

1/2" Kolovrátek
1/2" Speed brace
1/2" Kurbel

kód/Code Bestellnummer	L (mm)	A (mm)	W (g)		DPC/RRP (Kč/czk)	DPC/RRP (EUR)	EAN13
4CZ-125-10-407	407	12	478	5	392,56	16,36	8592667037519

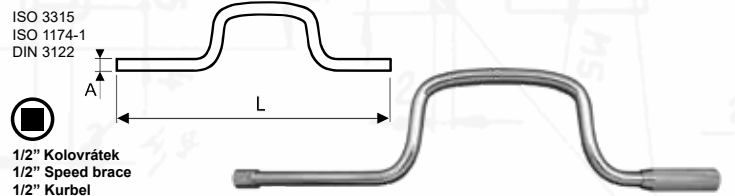

ISO 3315
DIN 3122

1/2" Kloubové vratidlo
1/2" Hinged handle
1/2" Gelenkegriff

kód/Code Bestellnummer	L (mm)	A (mm)	B (mm)	W (g)		DPC/RRP (Kč/czk)	DPC/RRP (EUR)	EAN13
4CZ-125-06-380	380	40,7	20,4	704	5	861,16	35,88	8592667037458
4CZ-125-06-600	600	41	34	1282	3	924,79	38,53	8592667037465

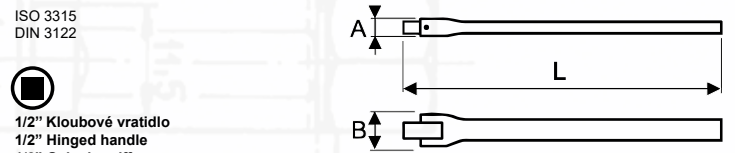



ISO 2725-1
 ISO 1711-2
 ISO 2725-2
 DIN 3124

4CZech® ONE

1/2" Sada hlavice na liště - 4CZech ONE 8-10-12-13-14-16-17-18-19-21mm
 1/2" Socket set in rail - 4CZech ONE 8-10-12-13-14-16-17-18-19-21mm
 1/2" Steckschlüsselsatz auf der Leiste - 4CZech ONE 8-10-12-13-14-16-17-18-19-21mm

kód/Code Bestellnummer	W (g)		DPC/RRP (Kč/czk)	DPC/RRP (EUR)	EAN13
4CZ-126-L01	657	1	664,46	27,69	8592667200609

i **Metrické**
Metric
Metrisch



obsah / content / Inhalt	velikost / size / Größe
1/2" hlavice 4CZech ONE / sockets 4CZech ONE / Steckschlüssel-Einsatz 4CZech ONE	8 - 10 - 12 - 13 - 14 - 16 - 17 - 18 - 19 - 21mm



1/2" Sada hlavice na liště - 4CZech 12ti hranné 8-10-12-13-14-16-17-18-19-21mm
 1/2" Socket set in rail - 4CZech Bi-hexagonal 8-10-12-13-14-16-17-18-19-21mm
 1/2" Steckschlüsselsatz auf der Leiste - 4CZech 12-kant 8-10-12-13-14-16-17-18-19-21mm

kód/Code Bestellnummer	W (g)		DPC/RRP (Kč/czk)	DPC/RRP (EUR)	EAN13
4CZ-126-L011	646	1	665,29	27,72	8592667201071

i **Metrické**
Metric
Metrisch

obsah / content / Inhalt	velikost / size / Größe
1/2" hlavice 12-ti hranné / socket Bi-hexagonal / Steckschlüssel-Einsatz 12-kant	8 - 10 - 12 - 13 - 14 - 16 - 17 - 18 - 19 - 21mm



1/2" Sada hlavice na liště - 4CZech ONE palcové 5/16"-3/8"-7/16"-1/2"-9/16"-5/8"-21/32"-11/16"-3/4"-7/8"
 1/2" Socket set in rail - 4CZech ONE Inch 8-10-12-13-14-16-17-18-19-21mm
 1/2" Steckschlüsselsatz auf der Leiste - 4CZech ONE Zoll 8-10-12-13-14-16-17-18-19-21mm

kód/Code Bestellnummer	W (g)		DPC/RRP (Kč/czk)	DPC/RRP (EUR)	EAN13
4CZ-126-LI01	662	1	671,07	27,96	8592667201088

i **Palcové**
Inch
Zoll

obsah / content / Inhalt	velikost / size / Größe
1/2" hlavice 4CZech ONE / sockets 4CZech ONE / Steckschlüssel-Einsatz 4CZech ONE	5/16" - 3/8" - 7/16" - 1/2" - 9/16" - 5/8" - 21/32" - 11/16" - 3/4" - 7/8"



ISO 2725-1 ISO 1173
 ISO 1711-2 DIN 3126
 ISO 2725-2 ISO 3316
 DIN 3124 DIN 3123

4CZech® ONE

1/2" Sada hlavice na liště - 4CZech ONE 8-9-10-11-12-13-14-15-16-17-18-19-20-21-22-23-24-25-26-27-28-29-30-32-34, 36 mm + Adaptér na bity 10mm-5/16" + Redukce 3/8" + Redukce 3/4" + kardan
 1/2" Socket set in rail - 4CZech ONE 8-9-10-11-12-13-14-15-16-17-18-19-20-21-22-23-24-25-26-27-28-29-30-32-34, 36mm + Bit holder 10mm-5/16" + Coupler 3/8" + Coupler 3/4" + Joint
 1/2" Steckschlüsselsatz auf der Leiste - 4CZech ONE 8-9-10-11-12-13-14-15-16-17-18-19-20-21-22-23-24-25-26-27-28-29-30-32-34, 36mm + Bittadapter 10mm-5/16" + Reduktion 3/8" + Reduktion 3/4" + Kardangelenk

kód/Code Bestellnummer	W (g)		DPC/RRP (Kč/czk)	DPC/RRP (EUR)	EAN13
4CZ-126-L10	3343	1	3262,81	135,95	8592667204027

i **Metrické**
Metric
Metrisch

obsah / content / Inhalt	velikost / size / Größe
1/2" hlavice 4CZech One / sockets 4CZech One / Steckschlüssel-Einsatz 4CZech One	8 - 9 - 10 - 11 - 12 - 13 - 14 - 15 - 16 - 17 - 18 - 19 - 20 - 21 - 22 - 23 - 24 - 25 - 26 - 27 - 28 - 29 - 30 - 32 - 34mm
1/2" hlavice / sockets / Steckschlüssel-Einsatz	36mm
1/2" Adaptér na bity / Bit holder / Bitadapter	10mm - 5/16"
1/2" redukce / sliding adapter / Reduktion	3/8" - 3/4"
1/2" Univerzální kardan / Universal joint / Universal-Kardangelenk	77mm

1/2" Sada hlavice na liště - 4CZech 12ti hranné 8-9-10-11-12-13-14-15-16-17-18-19-20-21-22-23-24-25-26-27-28-29-30-32-36mm + Adaptér na bity 10mm-5/16" + Redukce 3/8" + Redukce 3/4" + kardan
 1/2" Socket set in rail - 4CZech Bi-hexagonal 8-9-10-11-12-13-14-15-16-17-18-19-20-21-22-23-24-25-26-27-28-29-30-32-36mm + Bit holder 10mm-5/16" + Coupler 3/8" + Coupler 3/4" + Joint
 1/2" Steckschlüsselsatz auf der Leiste - 4CZech 12-kant 8-9-10-11-12-13-14-15-16-17-18-19-20-21-22-23-24-25-26-27-28-29-30-32-36mm + Bittadapter 10mm-5/16" + Reduktion 3/8" + Reduktion 3/4" + Kardangelenk



kód/Code Bestellnummer	W (g)		DPC/RRP (Kč/czk)	DPC/RRP (EUR)	EAN13
4CZ-126-L101	3070	1	3142,98	130,96	8592667204034

i **Metrické**
Metric
Metrisch

obsah / content / Inhalt	velikost / size / Größe
1/2" hlavice 12-ti hranné / socket Bi-hexagonal / Steckschlüssel-Einsatz 12-kant	8 - 9 - 10 - 11 - 12 - 13 - 14 - 15 - 16 - 17 - 18 - 19 - 20 - 21 - 22 - 23 - 24 - 25 - 26 - 27 - 28 - 29 - 30 - 32 - 36mm
1/2" Adaptér na bity / Bit holder / Bitadapter	10mm - 5/16"
1/2" redukce / sliding adapter / Reduktion	3/8" - 3/4"
1/2" Univerzální kardan / Universal joint / Universal-Kardangelenk	77mm



ISO 2725-1
 ISO 1711-2
 ISO 2725-2
 DIN 3124

4CZech®
ONE



1/2" Sada hlavic prodloužených na liště - 4CZech ONE 8-10-12-13-14-16-17-18-19-21mm
 1/2" Deep socket set in rail - 4CZech ONE 8-10-12-13-14-16-17-18-19-21mm
 1/2" Steckschlüsselsatz verlängert auf der Leiste - 4CZech ONE 8-10-12-13-14-16-17-18-19-21mm

kód/Code Bestellnummer	W (g)		DPC/RRP (Kč/czk)	DPC/RRP (EUR)	EAN13
4CZ-126-L02	1200	1	1631,40	67,98	8592667200616

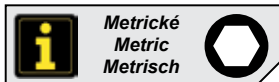

**Metrické
 Metric
 Metrisch**

obsah / content / Inhalt	velikost / size / Größe
1/2" Prodloužená hlavice 4CZech ONE / Long-reach socket 4CZech ONE / Steckschlüssel verlängert 4CZech ONE	8 - 10 - 12 - 13 - 14 - 16 - 17 - 18 - 19 - 21mm



1/2" Sada hlavic prodloužených na liště - 4CZech 12ti hranné 8-10-12-13-14-16-17-18-19-21mm
 1/2" Deep socket set in rail - 4CZech Bi-hexagonal 8-10-12-13-14-16-17-18-19-21mm
 1/2" Steckschlüsselsatz verlängert auf der Leiste - 4CZech 12-kant 8-10-12-13-14-16-17-18-19-21mm

kód/Code Bestellnummer	W (g)		DPC/RRP (Kč/czk)	DPC/RRP (EUR)	EAN13
4CZ-126-L021	1150	1	1640,50	68,35	8592667204010

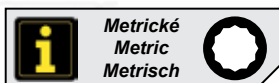

**Metrické
 Metric
 Metrisch**

obsah / content / Inhalt	velikost / size / Größe
1/2" Prodloužená hlavice 12-ti hranné / Long-reach socket Bi-hexagonal / Steckschlüssel verlängert 12-kant	8 - 10 - 12 - 13 - 14 - 16 - 17 - 18 - 19 - 21mm



ISO 2725-1 ISO 1173
 ISO 1711-2 DIN 3126
 ISO 2725-2 ISO 3316
 DIN 3124 DIN 3123

4CZech®
ONE

1/2" Sada hlavic prodloužených na liště - 4CZech One 8-10-12-13-14-15-16-17-18-19-21-22-24-27-30mm + Adaptér na bity 10mm-5/16" + Redukce 3/8" + Redukce 3/4" + kardan
 1/2" Deep socket set in rail - 4CZech One 8-10-12-13-14-15-16-17-18-19-21-22-24-27-30mm + Bit holder 10mm-5/16" + Coupler 3/8" + Coupler 3/4" + Joint
 1/2" Steckschlüsselsatz verlängert auf der Leiste - 4CZech One 8-10-12-13-14-15-16-17-18-19-21-22-24-27-30mm + Bittadapter 10mm-5/16" + Reduktion 3/8" + Reduktion 3/4" + Kardangelen

kód/Code Bestellnummer	W (g)		DPC/RRP (Kč/czk)	DPC/RRP (EUR)	EAN13
4CZ-126-L18	2870	1	3526,45	146,94	8592667204119

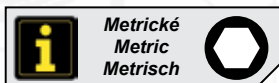

**Metrické
 Metric
 Metrisch**

obsah / content / Inhalt	velikost / size / Größe
1/2" Prodloužená hlavice 4CZech ONE / Long-reach socket 4CZech ONE / Steckschlüssel verlängert 4CZech ONE	8 - 10 - 12 - 13 - 14 - 15 - 16 - 17 - 18 - 19 - 21 - 22 - 24 - 27 - 30mm
1/2" Adaptér na bity / Bit holder / Bitadapter	10mm - 5/16"
1/2" redukce / sliding adapter / Reduktion	3/8" - 3/4"
1/2" Univerzální kardan / Universal joint / Universal-Kardangelen	77mm

1/2" Sada hlavic prodloužených na liště - 4CZech 12ti hranné 8-10-12-13-14-15-16-17-18-19-21-22-24-27-30mm + Adaptér na bity 10mm-5/16" + Redukce 3/8" + Redukce 3/4" + kardan
 1/2" Deep socket set in rail - 4CZech Bi-hexagonal 8-10-12-13-14-15-16-17-18-19-21-22-24-27-30mm + Bit holder 10mm-5/16" + Coupler 3/8" + Coupler 3/4" + Joint
 1/2" Steckschlüsselsatz verlängert auf der Leiste - 4CZech 12-kant 8-10-12-13-14-15-16-17-18-19-21-22-24-27-30mm + Bittadapter 10mm-5/16" + Reduktion 3/8" + Reduktion 3/4" + Kardangelen



kód/Code Bestellnummer	W (g)		DPC/RRP (Kč/czk)	DPC/RRP (EUR)	EAN13
4CZ-126-L181	2730	1	3535,54	147,31	8592667204126

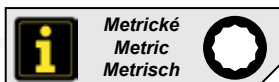

**Metrické
 Metric
 Metrisch**

obsah / content / Inhalt	velikost / size / Größe
1/2" Prodloužená hlavice 12-ti hranné / Long-reach socket Bi-hexagonal / Steckschlüssel verlängert 12-kant	8 - 10 - 12 - 13 - 14 - 15 - 16 - 17 - 18 - 19 - 21 - 22 - 24 - 27 - 30mm
1/2" Adaptér na bity / Bit holder / Bitadapter	10mm - 5/16"
1/2" redukce / sliding adapter / Reduktion	3/8" - 3/4"
1/2" Univerzální kardan / Universal joint / Universal-Kardangelen	77mm



ISO 2725-1
 ISO 1171-2
 ISO 2725-2
 DIN 3124



1/2" Sada hlavic prodloužených na liště - 4Czech 12ti hranné 8-9-10-11-12-13-14-15-16-17-18-19-20-21-22-23-24-25-26-27-28-29-30-32mm
 1/2" Deep socket set in rail - 4Czech Bi-hexagonal 8-9-10-11-12-13-14-15-16-17-18-19-20-21-22-23-24-25-26-27-28-29-30-32mm
 1/2" Steckschlüsselsatz verlängert auf der Leiste - 4CZech 12-kant 8-9-10-11-12-13-14-15-16-17-18-19-20-21-22-23-24-25-26-27-28-29-30-32mm

kód/Code	W (g)		DPC/RRP (Kč/czk)	DPC/RRP (EUR)	EAN13
4CZ-126-L191	4320	1	4204,96	175,21	8592667204133

obsah / content / Inhalt	velikost / size / Größe
1/2" Prodloužená hlavice 12-ti hranné / Long-reach socket Bi-hexagonal / Steckschlüssel verlängert 12-kant	8 - 9 - 10 - 11 - 12 - 13 - 14 - 15 - 16 - 17 - 18 - 19 - 20 - 21 - 22 - 23 - 24 - 25 - 26 - 27 - 28 - 29 - 30 - 32mm

ISO 2725-1
 ISO 1171-2
 ISO 2725-2
 DIN 3124



1/2" Sada hlavic na liště - nástrčná hlavice TRX E 8-10-11-12-14-16-18-20-22-24
 1/2" Socket set in rail - Socket TORX E 8-10-11-12-14-16-18-20-22-24
 1/2" Steckschlüsselsatz auf der Leiste - Steckschlüssel TRX E 8-10-11-12-14-16-18-20-22-24

kód/Code	W (g)		DPC/RRP (Kč/czk)	DPC/RRP (EUR)	EAN13
4CZ-126-L13	720	1	2044,63	85,19	8592667204065

obsah / content / Inhalt	velikost / size / Größe
1/2" Nástrčná hlavice TRX E / Socket TORX E / Steckschlüssel TRX E	8 - 10 - 11 - 12 - 14 - 16 - 18 - 20 - 22 - 24



ISO 2725-1
 ISO 1174-1
 DIN 3124



1/2" Sada hlavic zástrčných na liště - 6HR 4-5-6-7-8-9-10-12-14-17mm (délka 55mm)
 1/2" Hex socket set in rail - 4-5-6-7-8-9-10-12-14-17mm (length 55mm)
 1/2" Steckschlüssel-Einsatz-Satz auf der Leiste - 6HR 4-5-6-7-8-9-10-12-14-17mm (Länge 55mm)

kód/Code	W (g)		DPC/RRP (Kč/czk)	DPC/RRP (EUR)	EAN13
4CZ-126-L03	983	1	1290,91	53,79	8592667200623

obsah / content / Inhalt	velikost / size / Größe
1/2" Zástrčná hlavice imbus / HEX Bit socket / Steckschlüssel-Einsatz imbus	H4 - H5 - H6 - H7 - H8 - H9 - H10 - H12 - H14 - H17



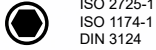

ISO 2725-1
 ISO 1174-1
 DIN 3124
 1/2" Sada hlavic zástrčných na liště - 6HR 4-5-6-7-8-10-12-14mm (délka 100mm)
 1/2" Hex socket set in rail - 4-5-6-7-8-10-12-14mm (length 100mm)
 1/2" Steckschlüssel-Einsatz-Satz auf der Leiste - 6HR 4-5-6-7-8-10-12-14mm (Länge 100mm)

kód/Code Bestellnummer	W (g)		DPC/RRP (Kč/czk)	DPC/RRP (EUR)	EAN13
4CZ-126-L04	951	1	1152,07	48,00	8592667200630

obsah / content / Inhalt	velikost / size / Größe
1/2" Zástrčná hlavice imbus prodloužená / HEX Bit socket long-reach type / Steckschlüssel-Einsatz imbus verlängert	H4 - H5 - H6 - H7 - H8 - H10 - H12 - H14



ISO 2725-1
 ISO 1174-1
 DIN 3124
 1/2" Sada hlavic zástrčných na liště - SL 5,5-8-10-12 PH 2-3-4 PZ 2-3-4
 1/2" Hex socket set in rail - SL 5,5-8-10-12 PH 2-3-4 PZ 2-3-4
 1/2" Steckschlüssel-Einsatz-Satz auf der Leiste - SL 5,5-8-10-12 PH 2-3-4 PZ 2-3-4

kód/Code Bestellnummer	W (g)		DPC/RRP (Kč/czk)	DPC/RRP (EUR)	EAN13
4CZ-126-L05	815	1	885,95	36,91	8592667200647

obsah / content / Inhalt	velikost / size / Größe
1/2" Zástrčná hlavice plochá / Slotted bit socket / Steckschlüssel-Einsatz Schlitz	SL5,5 - SL8 - SL10
1/2" Zástrčná hlavice phillips / PH Bit socket / Steckschlüssel-Einsatz Phillips	PH2 - PH3 - PH4
1/2" Zástrčná hlavice pozidrive / PZ Bit socket / Steckschlüssel-Einsatz Pozidriv	PZ2 - PZ3 - PZ4



ISO 1174-1
 1/2" Sada hlavic zástrčných na liště - TRX 25-30-40-45-50-55 TRX prodloužené 40-45-50-55
 1/2" Hex socket set in rail - TRX 25-30-40-45-50-55 deep TRX 40-45-50-55
 1/2" Steckschlüssel-Einsatz-Satz auf der Leiste - TRX 25-30-40-45-50-55 TRX verlängert 40-45-50-55

kód/Code Bestellnummer	W (g)		DPC/RRP (Kč/czk)	DPC/RRP (EUR)	EAN13
4CZ-126-L06	1010	1	1497,52	62,40	8592667200654

obsah / content / Inhalt	velikost / size / Größe
1/2" Zástrčná hlavice TRX / TORX Bit socket / Steckschlüssel-Einsatz TRX	T25 - T30 - T40 - T45 - T50 - T55
1/2" Zástrčná hlavice TRX prodloužená / TORX Bit socket long-reach type / Steckschlüssel-Einsatz TRX verlängert	T40 - T45 - T50 - T55

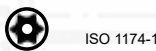

ISO 1174-1
 1/2" Sada hlavic zástrčných na liště - TRX s otvorem 20-25-27-30-40-45-50-55-60
 1/2" Hex socket set in rail - TRX with hole 20-25-27-30-40-45-50-55-60
 1/2" Steckschlüssel-Einsatz-Satz auf der Leiste - TRX mit Loch 20-25-27-30-40-45-50-55-60

kód/Code Bestellnummer	W (g)		DPC/RRP (Kč/czk)	DPC/RRP (EUR)	EAN13
4CZ-126-L07	775	1	1176,86	49,04	8592667200661

obsah / content / Inhalt	velikost / size / Größe
1/2" Zástrčná hlavice TRX s otvorem / TORX Bit socket with hole / Steckschlüssel-Einsatz TRX mit Loch	TT20 - TT25 - TT27 - TT30 - TT40 - TT45 - TT50 - TT55 ,TT60

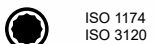

ISO 1174
 ISO 3120
 1/2" Sada hlavic zástrčných na liště - XZN M5-M6-M8-M10-M12-M14 XZN prodloužené M8-M10-M12-M14
 1/2" Hex socket set in rail - XZN M5-M6-M8-M10-M12-M14 deep XZN M8-M10-M12-M14
 1/2" Steckschlüssel-Einsatz-Satz auf der Leiste - XZN M5-M6-M8-M10-M12-M14 XZN verlängert M8-M10-M12-M14

kód/Code Bestellnummer	W (g)		DPC/RRP (Kč/czk)	DPC/RRP (EUR)	EAN13
4CZ-126-L08	1062	1	1552,07	64,67	8592667200678

obsah / content / Inhalt	velikost / size / Größe
1/2" Zástrčná hlavice XZN / XZN Bit socket / Steckschlüssel-Einsatz XZN	M5 - M6 - M8 - M10 - M12 - M14
1/2" Zástrčná hlavice XZN prodloužená / XZN Bit socket long-reach type / Steckschlüssel-Einsatz XZN verlängert	M8 - M10 - M12 - M14



ISO 2725-1 ISO 1173
ISO 1711-2 DIN 3126
ISO 2725-2 ISO 3316
DIN 3124 DIN 3123

4CZech®
ONE



1/2" Sada hlavice na liště - 4CZech ONE 8-10-13-17-19-22mm + Hlavice na svičky 21mm + Adaptér na bity 10mm-5/16" + Redukce 3/8" + Redukce 3/4" + kardan

1/2" Socket set in rail - 4CZech ONE 8-10-13-17-19-22mm + Spark plug 21mm + Bit holder 10mm-5/16" + Coupler 3/8" + Coupler 3/4" + Joint

1/2" Steckschlüsselsatz auf der Leiste - 4CZech ONE 8-10-13-17-19-22mm + Steckschlüssel für Zündkerzen 21mm + Bittadapter 10mm-5/16" + Reduktion 3/8" + Reduktion 3/4" + Kardangelenk

kód/Code Bestellnummer	W (g)		DPC/RRP (Kč/czk)	DPC/RRP (EUR)	EAN13
4CZ-126-L11	832	1	1274,38	53,10	8592667204041

obsah / content / Inhalt	velikost / size / Größe
1/2" hlavice 4CZech One / sockets 4CZech One / Steckschlüssel-Einsatz 4CZech One	8 - 10 - 13 - 17 - 19 - 22mm
1/2" hlavice na svičky / Spark plug / Steckschlüssel für Zündkerzen	21mm
1/2" Adaptér na bity / Bit holder / Bitadapter	10mm - 5/16"
1/2" redukce / sliding adapter / Reduktion	3/8" - 3/4"
1/2" Univerzální kardan / Universal joint / Universal-Kardangelenk	77mm

1/2" Sada hlavice na liště - 4CZech ONE 8-10-13-17-19-22mm + Hlavice na svičky 16mm + Adaptér na bity 10mm-5/16" + Redukce 3/8" + Redukce 3/4" + kardan

1/2" Socket set in rail - 4CZech ONE 8-10-13-17-19-22mm + Spark plug 16mm + Bit holder 10mm-5/16" + Coupler 3/8" + Coupler 3/4" + Joint

1/2" Steckschlüsselsatz auf der Leiste - 4CZech ONE 8-10-13-17-19-22mm + Steckschlüssel für Zündkerzen 16mm + Bittadapter 10mm-5/16" + Reduktion 3/8" + Reduktion 3/4" + Kardangelenk

kód/Code Bestellnummer	W (g)		DPC/RRP (Kč/czk)	DPC/RRP (EUR)	EAN13
4CZ-126-L12	780	1	1274,38	53,10	8592667204058

obsah / content / Inhalt	velikost / size / Größe
1/2" hlavice 4CZech One / sockets 4CZech One / Steckschlüssel-Einsatz 4CZech One	8 - 10 - 13 - 17 - 19 - 22mm
1/2" hlavice na svičky / Spark plug / Steckschlüssel für Zündkerzen	16mm
1/2" Adaptér na bity / Bit holder / Bitadapter	10mm - 5/16"
1/2" redukce / sliding adapter / Reduktion	3/8" - 3/4"
1/2" Univerzální kardan / Universal joint / Universal-Kardangelenk	77mm



ISO 1173
DIN 3126
ISO 2725-1
ISO 1711-2
ISO 2725-2
DIN 3124

4CZech®
ONE



1/2" Sada hlavice na liště - 4CZech ONE 8-9-10-11-33-34, 36mm + Adaptér na bity 10mm-5/16"

1/2" Socket set in rail - 4CZech ONE 8-9-10-11-33-34, 36mm + Bit holder 10mm-5/16"

1/2" Steckschlüsselsatz auf der Leiste - 4CZech ONE 8-9-10-11-33-34, 36mm + Bittadapter 10mm-5/16"

kód/Code Bestellnummer	W (g)		DPC/RRP (Kč/czk)	DPC/RRP (EUR)	EAN13
4CZ-126-L26	1022	1	1196,69	49,86	8592667204164

obsah / content / Inhalt	velikost / size / Größe
1/2" hlavice 4CZech One / sockets 4CZech One / Steckschlüssel-Einsatz 4CZech One	8 - 9 - 10 - 11 - 32 - 34mm
1/2" hlavice / sockets / Steckschlüssel-Einsatz	36mm
1/2" Adaptér na bity / Bit holder / Bitadapter	10mm - 5/16"

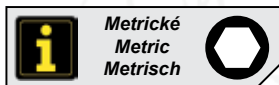

Rozšíření pro sadu 4CZ-126-26
Extension for set 4CZ-126-26
Erweiterung für den Satz 4CZ-126-26



1/2" Sada hlavice na liště - 4CZech 12ti hranné 8-9-10-11-33-34-36mm + Adaptér na bity 10mm-5/16"
1/2" Socket set in rail - 4CZech Bi-hexagonal 8-9-10-11-33-34-36mm + Bit holder 10mm-5/16"
1/2" Steckschlüsselsatz auf der Leiste - 4CZech ONE 8-9-10-11-33-34, 36mm + Bittadapter 10mm-5/16"

kód/Code Bestellnummer	W (g)		DPC/RRP (Kč/czk)	DPC/RRP (EUR)	EAN13
4CZ-126-L27	820	1	1075,21	44,80	8592667204171

obsah / content / Inhalt	velikost / size / Größe
1/2" hlavice 12-ti hranné / socket Bi-hexagonal / Steckschlüssel-Einsatz 12-kant	8 - 9 - 10 - 11 - 32 - 36mm
1/2" Adaptér na bity / Bit holder / Bitadapter	10mm - 5/16"

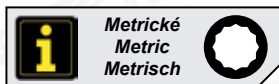

Rozšíření pro sadu 4CZ-127-26
Extension for set 4CZ-127-26
Erweiterung für den Satz 4CZ-127-26



ISO 1173
DIN 3126
ISO 2725-1
ISO 1711-2
ISO 2725-2
DIN 3124

4CZech®
ONE



1/2" Sada hlavice na liště - 4CZech ONE 20-25-26-28-29, 36mm + Adaptér na bity 10mm-5/16"

1/2" Socket set in rail - 4CZech ONE 20-25-26-28-29, 36mm + Bit holder 10mm-5/16"

1/2" Steckschlüsselsatz auf der Leiste - 4CZech 12-kant 20-25-26-28-29, 36mm + Bittadapter 10mm-5/16"

kód/Code Bestellnummer	W (g)		DPC/RRP (Kč/czk)	DPC/RRP (EUR)	EAN13
4CZ-126-L23	1230	1	852,89	35,54	8592667204140

obsah / content / Inhalt	velikost / size / Größe
1/2" hlavice 4CZech One / sockets 4CZech One / Steckschlüssel-Einsatz 4CZech One	20 - 25 - 26 - 28 - 29mm
1/2" hlavice / sockets / Steckschlüssel-Einsatz	36mm
1/2" Adaptér na bity / Bit holder / Bitadapter	10mm - 5/16"

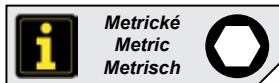

Rozšíření pro sadu 4CZ-126-23
Extension for set 4CZ-126-23
Erweiterung für den Satz 4CZ-126-23



1/2" Sada hlavice na liště - 4CZech 12ti hranné 20-25-26-28-29-36mm + Adaptér na bity 10mm-5/16"
1/2" Socket set in rail - 4CZech Bi-hexagonal 20-25-26-28-29-36mm + Bit holder 10mm-5/16"
1/2" Steckschlüsselsatz auf der Leiste - 4CZech 12-kant 20-25-26-28-29-36mm + Bittadapter 10mm-5/16"

kód/Code Bestellnummer	W (g)		DPC/RRP (Kč/czk)	DPC/RRP (EUR)	EAN13
4CZ-126-L231	1190	1	1076,86	44,87	8592667204157

obsah / content / Inhalt	velikost / size / Größe
1/2" hlavice 12-ti hranné / socket Bi-hexagonal / Steckschlüssel-Einsatz 12-kant	20 - 25 - 26 - 28 - 29 - 36mm
1/2" Adaptér na bity / Bit holder / Bitadapter	10mm - 5/16"

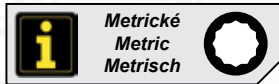

Rozšíření pro sadu 4CZ-127-23
Extension for set 4CZ-127-23
Erweiterung für den Satz 4CZ-127-23



ISO 1174-1
 ISO 2725-1
 ISO 1711-2
 ISO 2725-2
 DIN 3124



1/2" Sada hlavic na liště - 4CZech ONE 10-13-17-19mm + Zástrčná hlavice plochá SL 5,5-8-10-12-14-16
 1/2" Socket set in rail - 4CZech ONE 10-13-17-19mm + Slotted bit socket SL 5,5-8-10-12-14-16
 1/2" Steckschlüsselsatz auf der Leiste - 4CZech One 10-13-17-19mm + Steckschlüssel-Einsatz Schlitz SL 5,5-8-10-12-14-16

kód/Code Bestellnummer	W (g)		DPC/RRP (Kč/czk)	DPC/RRP (EUR)	EAN13
4CZ-126-L14	820	1	869,42	36,23	8592667204072

obsah / content / Inhalt		velikost / size / Größe	
1/2" hlavice 4CZech One / sockets 4CZech One / Steckschlüssel-Einsatz 4CZech One		10 - 13 - 17 - 19mm	
1/2" Zástrčná hlavice plochá / Slotted bit socket / Steckschlüssel-Einsatz Schlitz		SL5,5 - SL8 - SL10 - SL12 - SL14 - SL16	



ISO 1174-1
 ISO 2725-1
 ISO 1711-2
 ISO 2725-2
 DIN 3124



1/2" Sada hlavic na liště - 4CZech ONE 8-10-13-16-17-19mm + Zástrčná hlavice phillips PH 1-2-3-4
 1/2" Socket set in rail - 4CZech ONE 8-10-13-16-17-19mm + Phillips Bit socket PH 1-2-3-4
 1/2" Steckschlüsselsatz auf der Leiste - 4CZech One 8-10-13-16-17-19mm + Steckschlüssel-Einsatz Phillips PH 1-2-3-4

kód/Code Bestellnummer	W (g)		DPC/RRP (Kč/czk)	DPC/RRP (EUR)	EAN13
4CZ-126-L15	690	1	744,63	31,03	8592667204089

obsah / content / Inhalt		velikost / size / Größe	
1/2" hlavice 4CZech One / sockets 4CZech One / Steckschlüssel-Einsatz 4CZech One		8 - 10 - 13 - 16 - 17 - 19mm	
1/2" Zástrčná hlavice phillips / PH Bit socket / Steckschlüssel-Einsatz Phillips		PH1 - PH2 - PH3 - PH4	



ISO 1174-1
 ISO 2725-1
 ISO 1711-2
 ISO 2725-2
 DIN 3124



1/2" Sada hlavic na liště - 4CZech ONE 8-10-13-16-17-19mm + Zástrčná hlavice pozidrive PZ 1-2-3-4
 1/2" Socket set in rail - 4CZech ONE 8-10-13-16-17-19mm + Pozidriv Bit socket PZ 1-2-3-4
 1/2" Steckschlüsselsatz auf der Leiste - 4CZech One 8-10-13-16-17-19mm + Steckschlüssel-Einsatz Pozidriv PZ 1-2-3-4

kód/Code Bestellnummer	W (g)		DPC/RRP (Kč/czk)	DPC/RRP (EUR)	EAN13
4CZ-126-L16	690	1	744,63	31,03	8592667204096

obsah / content / Inhalt		velikost / size / Größe	
1/2" hlavice 4CZech One / sockets 4CZech One / Steckschlüssel-Einsatz 4CZech One		8 - 10 - 13 - 16 - 17 - 19mm	
1/2" Zástrčná hlavice pozidrive / PZ Bit socket / Steckschlüssel-Einsatz Pozidriv		PZ1 - PZ2 - PZ3 - PZ4	



ISO 1174
 ISO 3120
 ISO 2725-1
 ISO 1711-2
 ISO 2725-2
 DIN 3124



1/2" Sada hlavic na liště - 4CZech ONE 10-13-17-19mm + Zástrčná hlavice XZN 5-6-8-10-12-14-16
 1/2" Socket set in rail - 4CZech ONE 10-13-17mm + XZN Bit socket 5-6-8-10-12-14-16
 1/2" Steckschlüsselsatz auf der Leiste - 4CZech One 10-13-17mm + Steckschlüssel-Einsatz XZN 5-6-8-10-12-14-16

kód/Code Bestellnummer	W (g)		DPC/RRP (Kč/czk)	DPC/RRP (EUR)	EAN13
4CZ-126-L17	840	1	1097,52	45,73	8592667204102

obsah / content / Inhalt		velikost / size / Größe	
1/2" hlavice 4CZech One / sockets 4CZech One / Steckschlüssel-Einsatz 4CZech One		10 - 13 - 17mm	
1/2" Zástrčná hlavice XZN / XZN Bit socket / Steckschlüssel-Einsatz XZN		M5 - M6 - M8 - M10 - M12 - M14 - M16	

1/2" Držák hlavic - lišta 260mm pro 10 hlavic
 1/2" Socket holder - rail 260mm for 10 sockets
 1/2" Steckschlüsselhalter - Leiste 260mm für 10 Steckschlüssel

kód/Code Bestellnummer	S (mm)	L (mm)	A (mm)	W (g)		DPC/RRP (Kč/czk)	DPC/RRP (EUR)	EAN13
4CZ-125-90	10	260	20	49	1	65,29	2,72	8592667193260





ISO 2725-1
 DIN 3124
 ISO 2725-2
 ISO 3315
 DIN 3122
 ISO 3120

Rozměr / dimensions / Dimensionen:
 420x250x90mm



1/2" 23-dílná sada nářadí 8-32mm + ráčna 72 zubů
 1/2" 23 pcs socket set 8-32mm + reversible ratchet 72 teeth
 1/2" 23-teiliger Steckschlüsselsatz 8-32mm + Knarre 72 Zähne

kód/Code Bestellnummer	W (g)		DPC/RRP (Kč/czsk)	DPC/RRP (EUR)	EAN13
4CZ-126-23	4360	5	2361,98	98,42	8592667037397

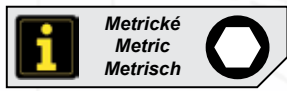

obsah / content / Inhalt	velikost / size / Größe
1/2" hlavice 4CZech ONE / sockets 4CZech ONE / Steckschlüssel-Einsatz 4CZech ONE	8,9,10,11,12,13,14,15,16,17,18,19,21,22,23,24,27,30,32mm
1/2" ráčna / ratchet / Knarre	250mm
1/2" zajišťovací nástavec / locking extension bar / Verriegelbare Verlängerung	155,280mm
1/2" univerzální kardan / universal joint / Universal-Kardangelen	77mm

1/2" 23-dílná sada nářadí 8-32mm 12-ti hranné + ráčna 72 zubů
 1/2" 23 pcs socket set 8-32mm bi-hexagonal + reversible ratchet 72 teeth
 1/2" 23-teiliger Steckschlüsselsatz 8-32mm 12-kant + Knarre 72 Zähne

kód/Code Bestellnummer	W (g)		DPC/RRP (Kč/czsk)	DPC/RRP (EUR)	EAN13
4CZ-127-23	4360	5	2368,60	98,69	8592667750159

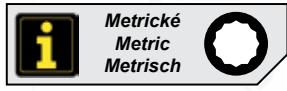

obsah / content / Inhalt	velikost / size / Größe
1/2" hlavice 4CZech ONE / sockets 4CZech ONE / Steckschlüssel-Einsatz 4CZech ONE	8,9,10,11,12,13,14,15,16,17,18,19,21,22,23,24,27,30,32mm
1/2" ráčna / ratchet / Knarre	250mm
1/2" zajišťovací nástavec / locking extension bar / Verriegelbare Verlängerung	155,280mm
1/2" univerzální kardan / universal joint / Universal-Kardangelen	77mm

1/2" 23-dílná sada nářadí 5/16" - 1 3/16" + ráčna 72 zubů
 1/2" 23 pcs socket set 5/16" - 1 3/16" + reversible ratchet 72 teeth
 1/2" 23-teiliger Steckschlüsselsatz 5/16" - 1 3/16" + Knarre 72 Zähne

kód/Code Bestellnummer	W (g)		DPC/RRP (Kč/czsk)	DPC/RRP (EUR)	EAN13
4CZ-126-123	4438	5	2547,93	106,16	8592667191525

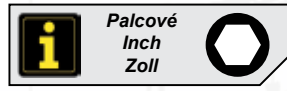

obsah / content / Inhalt	velikost / size / Größe
1/2" hlavice 4CZech ONE / sockets 4CZech ONE / Steckschlüssel-Einsatz 4CZech ONE	5/16";3/8";7/16";1/2";9/16";19/32";5/8";21/32";11/16";3/4"; 25/32";13/16";7/8";15/16";31/32";1";1-1/16";1-1/8";1-3/16"
1/2" ráčna / ratchet / Knarre	250mm
1/2" zajišťovací nástavec / locking extension bar / Verriegelbare Verlängerung	155,280mm
1/2" univerzální kardan / universal joint / Universal-Kardangelen	77mm

4CZech®

CZECH REPUBLIC - Industry line

HLAVICE, SADY HLAVIC A RÁČNY SOCKETS, SETS OF SOCKETS AND RATCHETS STECKSCHLÜSSEL, STECKSCHLÜSSEL-SÄTZE UND KNARREN



Rozměr
dimensions
Dimensionen:
450x185x50mm



1/2" 26-dílná sada nářadí 12-32mm + ráčna 72 zubů
1/2" 26 pcs socket set 12-32mm + reversible ratchet 72 teeth
1/2" 23-teiligiger Steckschlüsselsatz 12-32mm + Knarre 72 Zähne

4CZech® ONE

kód/Code Bestellnummer	W (g)		DPC/RRP (Kč/czk)	DPC/RRP (EUR)	EAN13
4CZ-126-26	6240	4	3382,64	140,94	8592667038462

obsah / content / Inhalt	velikost / size / Größe
1/2" nástavec / extension bar / Verlängerung	250mm
1/2" vratidlo / sliding bar (T handle) / Gleitgriff	125,250,300mm
1/2" univerzální kardan / universal joint / Universal-Kardangelen	77mm
1/2" hlavice na svíčky 21mm / spark plug 21mm / Steckschlüssel für Zündkerzen 21mm	64mm
1/2" kolovrátek / speed brace / Kurbel	407mm
1/2" hlavice 4CZech ONE / sockets 4CZech ONE / Steckschlüssel-Einsatz 4CZech ONE	12,13,14,15,16,17,18,19,20,21,22,23,24,25,26,27,28,30,32mm

ISO 2725-1
DIN 3124
ISO 2725-2
ISO 3315
DIN 3122
ISO 3120

1/2" 26-dílná sada nářadí 12-32mm 12-ti hranné + ráčna 72 zubů
1/2" 26 pcs socket set 12-32mm bi-hexagonal + reversible ratchet 72 teeth
1/2" 23-teiligiger Steckschlüsselsatz 12-32mm 12-kant + Knarre 72 Zähne

kód/Code Bestellnummer	W (g)		DPC/RRP (Kč/czk)	DPC/RRP (EUR)	EAN13
4CZ-127-26	6240,00	4	3386,78	141,12	8592667194892

obsah / content / Inhalt	velikost / size / Größe
1/2" nástavec / extension bar / Verlängerung	250mm
1/2" vratidlo / sliding bar (T handle) / Gleitgriff	125,250,300mm
1/2" univerzální kardan / universal joint / Universal-Kardangelen	77mm
1/2" hlavice na svíčky 21mm / spark plug 21mm / Steckschlüssel für Zündkerzen 21mm	64mm
1/2" kolovrátek / speed brace / Kurbel	407mm
1/2" hlavice 12-ti hranné / socket Bi-hexagonal / Steckschlüssel-Einsatz 12-kant	12,13,14,15,16,17,18,19,20,21,22,23,24,25,26,27,28,30,32mm



Rozměr
dimensions
Dimensionen:
510x310x90mm

1/4" + 1/2" 59-dílná sada nářadí 4-32mm + 2 ráčny 72 zubů
1/4" + 1/2" 59 pcs socket set 4-32mm + 2 reversible ratchets 72 teeth
1/4" + 1/2" 59-teiligiger Steckschlüsselsatz 4-32mm + 2 Knarren 72 Zähne

4CZech® ONE

kód/Code Bestellnummer	W (g)		DPC/RRP (Kč/czk)	DPC/RRP (EUR)	EAN13
4CZ-146-59-120	5880	2	4762,81	198,45	8592667037885

obsah / content / Inhalt	velikost / size / Größe
1/2" zajišťovací nástavec / locking extension bar / Verriegelbare Verlängerung	250mm
1/2" vratidlo / sliding bar (T handle) / Gleitgriff	280mm
1/2" univerzální kardan / universal joint / Universal-Kardangelen	125,300mm
1/2" hlavice na svíčky / spark plug / Steckschlüssel für Zündkerzen	77mm
1/2" hlavice 4CZech ONE / sockets 4CZech ONE / Steckschlüssel-Einsatz 4CZech ONE	16,21mm
1/4" ráčna / ratchet / Knarre	10,11,12,13,14,15,16,17,18,19, 21,22,24,27,30,32mm
1/4" zajišťovací nástavec / locking extension bar / Verriegelbare Verlängerung	130mm
1/4" vratidlo / sliding bar (T handle) / Gleitgriff	140mm
1/4" univerzální kardan / universal joint / Universal-Kardangelen	75,115mm
1/4" hlavice 4CZech ONE / sockets 4CZech ONE / Steckschlüssel-Einsatz 4CZech ONE	37mm
1/4" adapter na bity / bit holder / Bithalter	4,5,6,7,8,9,10,11,12,13mm
magnetický držák s rukojetí / magnetic spinner handle / Magnetischer Bithalter mit Handgriff	1/4"
bit křížový phillips / bit phillips / Bit Phillips	200mm
bit plochý / bit slotted / Bit Schlitz	PH1, PH2
bit šestihranný imbus / bit hexagon imbus / Bit Sechskant Imbus	SL4, SL5,5
bit TRX / bit TORX / Bit TORX	H3, H4, H5, H6
šestihranné zástrčné klíče / hexagon allen key wrench / 6-kant-Winkelschraubendreher	T10, T15, T20, T25, T30, T45
bit šestihranný imbus / bit hexagon imbus / Bit Sechskant Imbus	1.25, 1.5, 2.0, 2.5, 3.0mm
bit TRX / bit TORX / Bit TORX	H3, H4, H5, H6
šestihranné zástrčné klíče / hexagon allen key wrench / 6-kant-Winkelschraubendreher	T10, T15, T20, T25, T30, T45
	1.25, 1.5, 2.0, 2.5, 3.0mm



ISO 2725-1
DIN 3124
ISO 2725-2
ISO 3315
DIN 3122
ISO 3120

Uvedené ceny jsou DPC (doporučené prodejní ceny) v Kč a EUR bez DPH.
All prices mentioned are DPC (RRP - recommended retail price) in CZK and EUR without VAT.
Alle Preise sind EV-Preise (empfohlene Verkaufspreise) in CZK und EUR ohne MwSt.

1/2"



HLAVICE, SADY HLAVIC A RÁČNY
SOCKETS, SETS OF SOCKETS AND RATCHETS
STECKSCHLÜSSEL, STECKSCHLÜSSEL-SÄTZE UND KNARREN

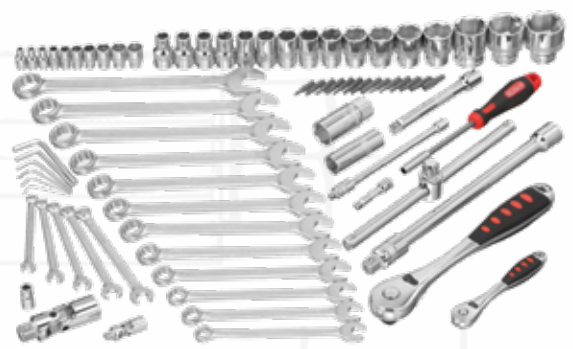

Rozměr / dimensions / Dimensionen:
510x310x90mm



1/4" + 1/2" 76-dílná sada nářadí 4-32mm + 2 ráčny 72 zubů + klíče
 1/4" + 1/2" 76 pcs socket set 4-32mm + 2 reversible ratchets 72 teeth + wrenches
 1/4" + 1/2" 76-teiliger Steckschlüsselsatz 4-32mm + 2 Knarren 72 Zähne + Schlüssel



kód/Code Bestellnummer	W (g)		DPC/RRP (Kč/czkc)	DPC/RRP (EUR)	EAN13
4CZ-146-76-120	8000	1	7063,64	294,32	8592667138858

ISO 2725-1, DIN 3124,
 ISO 2725-2, ISO 3315,
 DIN 3122, ISO 691,
 ISO 1711-1, ISO 3318,
 ISO 7738, DIN 3113
 ISO 3120

obsah / content / Inhalt	velikost / size / Größe
1/2" ráčna / ratchet / Knarre	250mm
1/2" zajišťovací nástavec / locking extension bar / Verriegelbare Verlängerung	280mm
1/2" nástavec / extension bar / Verlängerung	125mm
1/2" vratidlo / sliding bar (T handle) / Gleitgriff	300mm
1/2" univerzální kardan / universal joint / Universal-Kardangelenk	77mm
1/2" hlavice na svíčky / spark plug / Steckschlüssel für Zündkerzen	16,21mm
1/2" hlavice 4Czech ONE / sockets 4Czech ONE / Steckschlüssel-Einsatz 4Czech ONE	10,11,12,13,14,15,16,17,18,19,21,22,24,27,30,32mm
1/4" ráčna / ratchet / Knarre	130mm
1/4" zajišťovací nástavec / locking extension bar / Verriegelbare Verlängerung	140mm
1/4" nástavec / extension bar / Verlängerung	75mm
1/4" vratidlo / sliding bar (T handle) / Gleitgriff	115mm
1/4" univerzální kardan / universal joint / Universal-Kardangelenk	37mm
1/4" adapter na bity / bit holder / Bithalter	1/4"
1/4" hlavice 4Czech ONE / sockets 4Czech ONE / Steckschlüssel-Einsatz 4Czech ONE	4,5,6,7,8,9,10,11,12,13mm
bit křížový phillips / bit phillips / Bit Phillips	PH1, PH2
bit plochý / bit slotted / Bit Schlitz	SL4, SL5,5
bit šestihřanný imbus / bit hexagon imbus / Bit Sechskant Imbus	H3, H4, H5, H6
bit TRX / bit TORX / Bit TORX	T10, T15, T20, T25, T30, T45
šestihřanný zástrčný klíč / hexagon allen key wrench / 6-kant-Winkelschraubendreher	1,25, 1,5, 2,0, 2,5, 3,0mm
magnetický držák s rukojetí / magnetic spinner handle / Magnetischer Bithalter mit Handgriff	1/4" - 200mm
očkoplochý klíč / combination spanner / Ring-Maulschlüssel	6,7,8,9,10,11,12,13,14,15,16,17,18,19,20,21,22mm



4Czech®

CZECH REPUBLIC - Industry line

HLAVICE, SADY HLAVIC A RÁČNY
SOCKETS, SETS OF SOCKETS AND RATCHETS
STECKSCHLÜSSEL, STECKSCHLÜSSEL-SÄTZE UND KNARREN

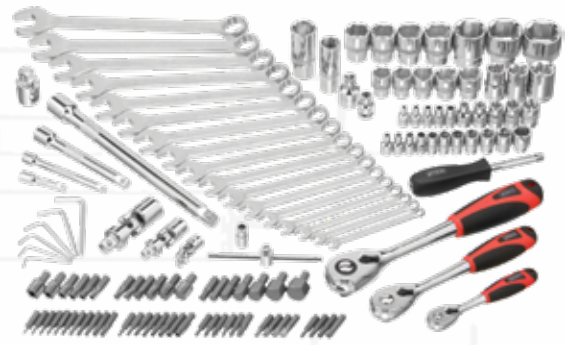

Rozměr / dimensions / Dimensionen:
510x310x90mm

ISO 2725-1, DIN 3124,
ISO 2725-2, ISO 3315,
DIN 3122, ISO 691,
ISO 1711-1, ISO 3318,
ISO 7738, DIN 3113
ISO 3120



1/4" + 3/8" + 1/2" 130-dílná sada nářadí 4-32mm + 3 ráčny 72 zubů + klíče
 1/4" + 3/8" + 1/2" 130 pcs socket set 4-32mm + 3 reversible ratchets 72 teeth + wrenches
 1/4" + 3/8" + 1/2" 130-teiliger Steckschlüsselsatz 4-32mm + 3 Knarren 72 Zähne + Schlüssel

4Czech® ONE

kód/Code Bestellnummer	W (g)		DPC/RRP (Kč/czk)	DPC/RRP (EUR)	EAN13
4CZ-146-130-380-120	7380	1	8901,65	370,90	8592667138841

obsah / content / Inhalt	velikost / size / Größe
1/2" Ráčna oválná / Oval Ratchet Handle / Ovale Knarre	257mm
1/2" nástavec / Extension bar / Verlängerung	250mm
1/2" Univerzální kardan / Universal joint / Universal-Kardangelen	77
1/2" Adaptér na bity 5/16" / Bit holder for 5/16" / Bitadapter 5/16"	1/2" - 5/16"
1/2" hlavice 4Czech One / sockets 4Czech One / Steckschlüssel-Einsatz 4Czech One	20, 21, 22, 24, 27, 30, 32mm
1/2" hlavice na svíčky / spark plug / Steckschlüssel für Zündkerzen	16, 21mm
1/2" nástrčná hlavice / E-Star sockets / Steckschlüssel TRX E	E18, E20, E24
1/2" bit šestihřanný imbus 30mm / bit hexagon imbus 30mm / Bit Sechskant Imbus 30mm	H7, H8, H10, H12, H14, H17, H19
1/2" bit TRX 30mm / T-Star Bit without tamperproof 30mm / Bit TORX 30mm	T40, T45, T50, T55, T60, T70
1/2" bit TRX s otvorem 30mm / T-Star Bit tamperproof 30mm / Bit TORX mit Loch 30mm	TT40, TT45, TT50, TT55,
3/8" Ráčna oválná / Oval Ratchet Handle / Ovale Knarre	200mm
3/8" nástavec / Extension bar / Verlängerung	125mm
3/8" Univerzální kardan / Universal joint / Universal-Kardangelen	55mm
3/8" hlavice 4Czech One / sockets 4Czech One / Steckschlüssel-Einsatz 4Czech One	15, 16, 17, 18, 19mm
3/8" nástrčná hlavice / E-Star sockets / Steckschlüssel TRX E	E8, E10, E12, E14, E16
3/8" Adaptér na bity / Bit holder / Bitadapter	3/8" x 5/16"
3/8" - 1/2" redukce / 3/8" - 1/2" sliding adapter / 3/8" - 1/2" Reduktion	35mm
1/4" vratidlo / 1/4" Sliding T bar / Gleitgriff	110mm
1/4" nástavec s rukojetí / Spinner handle / Verlängerung mit Handgriff	150mm
1/4" ráčna oválná / Oval Ratchet Handle / Ovale Knarre	130mm
1/4" nástavec / Extension bar / Verlängerung	50mm, 100mm
1/4" Univerzální kardan / Universal joint / Universal-Kardangelen	37mm
1/4" Adaptér na bity 1/4" HexF / Bit holder 1/4" dr x 1/4" / Bitadapter 1/4" HexF	25mm
1/4" hlavice 4Czech One / sockets 4Czech One / Steckschlüssel-Einsatz 4Czech One	4,5,6,7,8,9,10,11,12,13,14mm
1/4" nástrčná hlavice / E-Star sockets / Steckschlüssel TRX E	E4, E5, E6, E7, E8
1/4" bit křížový phillips 30mm / bit phillips 30mm / Bit Phillips 30mm	PH0, PH1, PH2
1/4" bit křížový pozidrive 30mm / bit pozidrive 30mm / Bit Pozidrív 30mm	PZ0, PZ1, PZ2
1/4" bit plochý 30mm / Bit slotted 30mm / Bit Schlitz 30mm	PL4, PL5, PL6,5, PL7
1/4" bit šestihřanný imbus 30mm / bit hexagon imbus 30mm / Bit Sechskant Imbus 30mm	H3, H4, H5, H6
1/4" bit TRX 30mm / T-Star Bit without tamperproof 30mm / Bit TORX 30mm	T5, T6, T7, T8, T9, T10, T15, T20, T25, T27, T30
1/4" bit TRX s otvorem 30mm / T-Star Bit tamperproof 30mm / Bit TORX mit Loch 30mm	TT10, TT15, TT20, TT25, TT27,
očkoplochý klíč / combination spanner / Ring-Maulschlüssel	6,7,8,9,10,11,12,13,14,15,16,17,18,19,20,21,22mm
šestihřanný zástrčný klíč / hexagon allen key wrench / 6-kant-Winkelschraubendreher	1,0, 1.5, 2, 2.5, 3, 4, 5mm

Uvedené ceny jsou DPC (doporučené prodejní ceny) v Kč a EUR bez DPH.
 All prices mentioned are DPC (RRP - recommended retail price) in CZK and EUR without VAT.
 Alle Preise sind EV-Preise (empfohlene Verkaufspreise) in CZK und EUR ohne MwSt.



Kód / Code / Bestellnummer

4CZ-34

3/4"

Industry
line

CrV

ISO 2725-1

ISO 3315
ISO 3316DIN 3122
DIN 3123
DIN 3124

POUŽITÍ

Nabízíme ucelený sortiment utahovacího nářadí. Klasické hlavice nástrčné, zástrčné, prodloužené, kardany, prodlužovací nástavce, redukce, vratidla, adaptéry, sady hlavíc a další příslušenství - velikosti 3/4". Zátěžové ráčny vysoké kvality s revolučním převodem.



USABILITY

We offer a complete range of tightening tools. Classic hex bit and torx sockets, prolonged sockets, universal joints, extension bars, coupler adaptors, sliding T handle bars, bit couplers, socket sets and other accessories - sizes 3/4". High-quality heavy-duty ratchets with the revolutionary gear.



VERWENDUNG

Wir bieten eine umfassende Palette von Handwerkzeugen. Klassische-Steckschlüssel, Einsätze, verlängerte Steckschlüssel, Kardangelenke, Verlängerungen, Reduktionen, Gleitgriffen, Adapter, Steckschlüsselsätze und anderes Zubehör - 3/4". Hochwertige Belastungsknarren mit revolutionärem Getriebe.

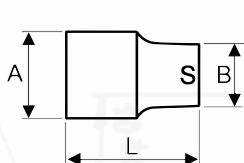
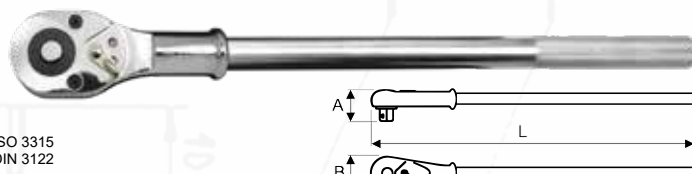
ISO 2725-1
DIN 31243/4" Hlavice
3/4" Socket
3/4" SteckschlüsselISO 3315
DIN 31223/4" Ráčna - komplet s rukojetí, zamykací, 24 zubů
3/4" Ratchet with handle, locking, 24 teeth
3/4" Knarre - komplett mit Griff, 24 Zähne

kód/Code Bestellnummer	S (mm)	L (mm)	A (mm)	B (mm)	W (g)		DPC/RRP (Kč/czk)	DPC/RRP (EUR)	EAN13
4CZ-341-01-19	19	50	29,2	32,9	167	5	277,69	11,57	8592667038134
4CZ-341-01-21	21	50	31,2	33	172	5	282,64	11,78	8592667038141
4CZ-341-01-22	22	50	32,2	36,0	215	5	287,60	11,98	8592667038158
4CZ-341-01-23	23	50	33,2	36,0	215	5	291,74	12,16	8592667038165
4CZ-341-01-24	24	51	34,2	36,1	222	5	346,28	14,43	8592667038172
4CZ-341-01-26	26	52	35,9	37,1	224	5	331,40	13,81	8592667038189
4CZ-341-01-27	27	52	36	37,8	228	5	346,28	14,43	8592667038196
4CZ-341-01-28	28	52	36	39,6	241	5	322,31	13,43	8592667038202
4CZ-341-01-29	29	52	36	40,6	242	5	346,28	14,43	8592667038219
4CZ-341-01-30	30	53	36	41,9	267	5	346,28	14,43	8592667038226
4CZ-341-01-32	32	56	36	44,3	280	5	357,85	14,91	8592667038233
4CZ-341-01-33	33	56	36	46,1	301	5	361,98	15,08	8592667038240
4CZ-341-01-34	34	56	36	47,2	315	5	392,56	16,36	8592667038257
4CZ-341-01-35	35	58	38	48,1	351	5	396,69	16,53	8592667038264
4CZ-341-01-36	36	58	38	50,2	384	5	404,96	16,87	8592667038271
4CZ-341-01-38	38	60	38	52,2	416	5	423,97	17,67	8592667038288
4CZ-341-01-40	40	62	40,1	54,2	444	5	476,86	19,87	8592667038295
4CZ-341-01-41	41	64	40,1	56,2	495	5	492,56	20,52	8592667038301
4CZ-341-01-42	42	64	40,1	57,2	495	5	533,88	22,25	8592667038318
4CZ-341-01-44	44	66	40,1	60,2	550	5	586,78	24,45	8592667038325
4CZ-341-01-46	46	66	40,1	62,2	595	5	589,26	24,55	8592667038332
4CZ-341-01-50	50	70	40,1	68,2	723	5	662,81	27,62	8592667038349
4CZ-341-01-54	54	74	45,1	72,2	897	5	828,93	34,54	8592667038356
4CZ-341-01-55	55	76	45,1	74,2	964	5	827,27	34,47	8592667038363

kód/Code Bestellnummer	L (mm)	A (mm)	B (mm)	W (g)		DPC/RRP (Kč/czk)	DPC/RRP (EUR)	EAN13
4CZ-344-01	500	58	63	2600	1	3028,93	126,21	8592667038387

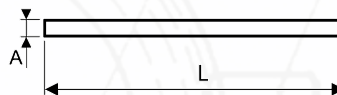
ISO 3315
DIN 31223/4" Rukojeť ráčny
3/4" Handle for ratchet
3/4" Knarregriff

kód/Code Bestellnummer	L (mm)	A (mm)	W (g)		DPC/RRP (Kč/czk)	DPC/RRP (EUR)	EAN13
4CZ-344-05	385	23,9	1353	2	636,36	26,52	8592667038394

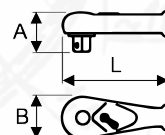
ISO 3315
DIN 31223/4" Hlava ráčny, zamykací, 24 zubů
3/4" Ratchet head, locking, 24 teeth
3/4" Knarrenkopf, 24 Zähne

kód/Code Bestellnummer	L (mm)	A (mm)	B (mm)	W (g)		DPC/RRP (Kč/czk)	DPC/RRP (EUR)	EAN13
4CZ-344-07	155	58	63	1245	2	2266,94	94,46	8592667038370

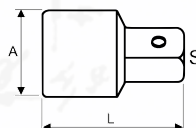
ISO 3316
DIN 31233/4" Redukce
3/4" Coupler
3/4" Reduktion

kód/Code Bestellnummer	S	L (mm)	A (mm)	W (g)		DPC/RRP (Kč/czk)	DPC/RRP (EUR)	EAN13
4CZ-345-01-100	1"	56	35,8	257	5	533,88	22,25	8592667038127
4CZ-345-01-120	1/2"	51,9	33,9	174	10	431,40	17,98	8592667038110

 Informace o balení - na straně 9
 Packing information on page 9
 Verpackungsinformationen auf Seite 9

 Pojistné tlačítko - na straně 15
 Safe push button - on page 15
 Sicherheitsknopf - auf Seite 15



ISO 3315
DIN 3122

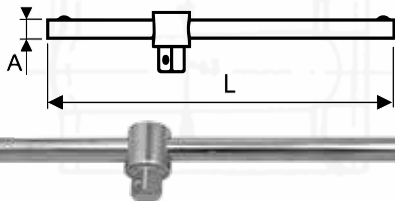

3/4" Vratidlo
3/4" Sliding bar (T handle)
3/4" Gleitgriff

kód/Code Bestellnummer	L (mm)	A (mm)	W (g)		DPC/RRP (Kč/czk)	DPC/RRP (EUR)	EAN13
4CZ-345-05-500	500	19,8	1521	2	969,42	40,39	8592667038431

ISO 3315
DIN 3122

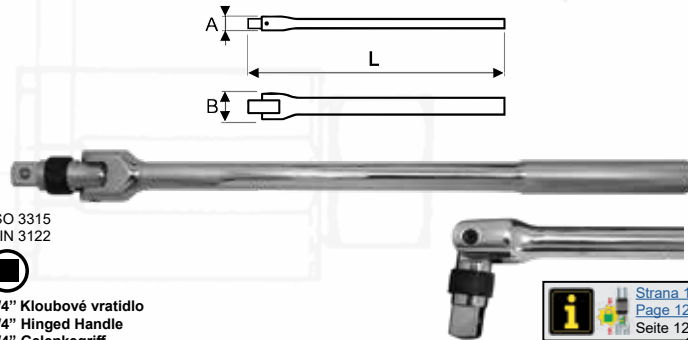

3/4" Kloubové vratidlo
3/4" Hinged Handle
3/4" Gelenkgriff

kód/Code Bestellnummer	L (mm)	A (mm)	B (mm)	W (g)		DPC/RRP (Kč/czk)	DPC/RRP (EUR)	EAN13
4CZ-345-06-525	525	80	40	1882	1	3369,42	140,39	8592667038448

[Strana 12](#)
[Page 12](#)
[Seite 12](#)

ISO 3316
DIN 3123

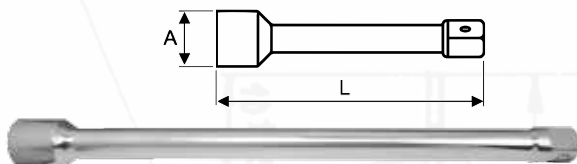

3/4" Nástavec
3/4" Extension bar
3/4" Verlängerung

kód/Code Bestellnummer	L (mm)	A (mm)	W (g)		DPC/RRP (Kč/czk)	DPC/RRP (EUR)	EAN13
4CZ-345-02-100	100	35,5	399	2	742,98	30,96	8592667038400
4CZ-345-02-200	200	35,5	714	2	804,96	33,54	8592667038417
4CZ-345-02-400	400	35,5	1359	2	1025,62	42,73	8592667038424

[Strana 9](#)
[Page 9](#)
[Seite 9](#)

ISO 3316
DIN 3123

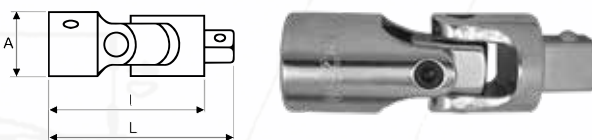

3/4" Univerzální kardan
3/4" Universal Joint
3/4" Universal-Kardangelen

kód/Code Bestellnummer	L (mm)	A (mm)	W (g)		DPC/RRP (Kč/czk)	DPC/RRP (EUR)	EAN13	
4CZ-345-07-106	106	86	40	578	2	1758,68	73,28	8592667038455

[Strana 9](#)
[Page 9](#)
[Seite 9](#)



ISO 2725-1
DIN 3124
ISO 2725-2
ISO 3315
DIN 3122
ISO 3120

3/4" 18-dílná sada nářadí 19-55mm + ráčna 24 zubů
3/4" 18 pcs socket set 19-55mm + reversible ratchet 24 teeth
3/4" 18-teiliger Steckschlüsselsatz 19-55mm + Knarre 24 Zähne

kód/Code Bestellnummer	W (g)		DPC/RRP (Kč/czk)	DPC/RRP (EUR)	EAN13
4CZ-346-18	14780	2	12831,40	534,64	8592667038004



Rozměr
dimensions
Dimensionen:
540x180x80mm



obsah / content / Inhalt	velikost / size / Größe
3/4" ráčna oválná / oval ratchet / Ovale Knarre	500mm
3/4" nástavec / extension bar / Verlängerung	200, 400mm
3/4" univerzální kardan / universal joint / Universal-Kardangelen	106mm
3/4" vratidlo / sliding bar (T handle) / Gleitgriff	450mm
3/4" hlavice / sockets / Steckschlüssel-Einsatz	19,21,22,24,27,30,32,34,36,41,46,50,55mm

[Informace o balení na straně 9](#)
[Packing information on page 9](#)
[Verpackungsinformationen auf Seite 9](#)

[Zajišťovací nástavce - na straně 12](#)
[Locking extension bars - on page 12](#)
[Verriegelbare Verlängerung - auf Seite 12](#)



Kód / Code / Bestellnummer

4CZ-10**1"**Industry
line**CrV**

ISO 2725-1

ISO 3315
ISO 3316DIN 3122
DIN 3123
DIN 3124**POUŽITÍ**

Nabízíme ucelený sortiment utahovacího nářadí. Klasické hlavice nástrčné, zástrčné, prodloužené, kardany, prodlužovací nástavce, redukce, vratidla, adaptéry, sady hlavice a další příslušenství - velikosti 1". Zátěžové ráčny vysoké kvality s revolučním převodem.

**USABILITY**

We offer a complete range of tightening tools. Classic hex bit and torx sockets, prolonged sockets, universal joints, extension bars, coupler adaptors, sliding T handle bars, bit couplers, socket sets and other accessories - sizes 1". High-quality heavy-duty ratchets with the revolutionary gear.

**VERWENDUNG**

Wir bieten eine umfassende Palette von Handwerkzeugen. Klassische-Steckschlüssel, Einsätze, verlängerte Steckschlüssel, Kardangelenke, Verlängerungen, Reduktionen, Gleitgriffen, Adapter, Steckschlüsselsätze und anderes Zubehör - 1". Hochwertige Belastungsknarren mit revolutionärem Getriebe.

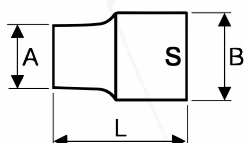
ISO 2725-1
DIN 31241" Hlavice
1" Socket
1" SteckschlüsselW Hmotnost
Weight
Gewicht

kód/Code Bestellnummer	S (mm)	L (mm)	A (mm)	B (mm)	W (g)		DPC/RRP (Kč/czk)	DPC/RRP (EUR)	EAN13
4CZ-101-01-41	41	70	45	57	585	1	768,60	32,02	8592667036307
4CZ-101-01-46	46	75	50	65	857	1	897,52	37,40	8592667036314
4CZ-101-01-50	50	75	50	70	928	1	1019,83	42,49	8592667036321
4CZ-101-01-55	55	80	55	76	1181	1	1225,62	51,07	8592667036338
4CZ-101-01-60	60	84	55	82	1379	1	1452,07	60,50	8592667036345
4CZ-101-01-65	65	87	55	87	1575	1	1804,13	75,17	8592667036352
4CZ-101-01-70	70	93	60	94	1983	1	2081,82	86,74	8592667036369
4CZ-101-01-75	75	97	60	100	2190	1	2367,77	98,66	8592667036376
4CZ-101-01-77	77	103	60	102	2390	1	2591,74	107,99	8592667573444
4CZ-101-01-80	80	104	60	105	2464	1	2612,40	108,85	8592667036383

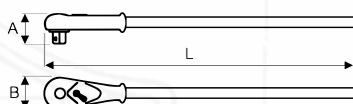
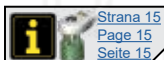
ISO 3315
DIN 31221" Ráčna oválná s prepínací páčkou, zamykací, 24 zubů
1" Reversible oval ratchet with switcher, locking, 24 teeth
1" Ovale Knarre mit Umschalthebel, 24 Zähne

kód/Code Bestellnummer	L (mm)	A (mm)	B (mm)	W (g)		DPC/RRP (Kč/czk)	DPC/RRP (EUR)	EAN13
4CZ-104-01	670	67	70	4676	1	5063,64	210,98	8592667040137

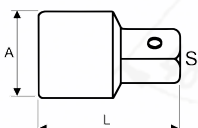
ISO 3316
DIN 31231" Redukce
1" Coupler
1" Reduktion

kód/Code Bestellnummer	S	L (mm)	A (mm)	W (g)		DPC/RRP (Kč/czk)	DPC/RRP (EUR)	EAN13
4CZ-105-01-340	3/4"	70	48	493	2	623,14	25,96	8592667036291



Pojistné tlačítko - na straně 15
Safe push button - on page 15
Sicherheitsknopf - auf Seite 15

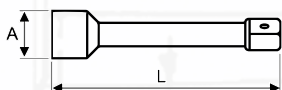

ISO 3316
DIN 3123



1" Nástavec
1" Extension bar
1" Verlängerung

kód/Code Bestellnummer	L (mm)	A (mm)	W (g)		DPC/RRP (Kč/czk)	DPC/RRP (EUR)	EAN13
4CZ-105-02-200	200	48,2	1120	1	1243,80	51,83	8592667036390
4CZ-105-02-400	400	48,2	1899	1	1858,68	77,44	8592667036406

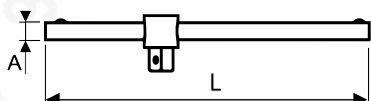

ISO 3315
DIN 3122



1" Vratidlo
1" Sliding bar (T handle)
1" Gleitgriff

kód/Code Bestellnummer	L (mm)	A (mm)	W (g)		DPC/RRP (Kč/czk)	DPC/RRP (EUR)	EAN13
4CZ-105-05-550	550	27,9	3400	1	2246,28	93,60	8592667042285



Rozměr
dimensions
Dimensionen:
645x205x95mm

ISO 2725-1
DIN 3124
ISO 2725-2
ISO 3315
DIN 3122
ISO 3120



1" 13-dílná sada nářadí 41-80mm + ráčna 24 zubů
1" 13 pcs socket set 41-80mm + reversible ratchet 24 teeth
1" 13-teiliger Steckschlüsselsatz 41-80mm + Knarre 24 Zähne

kód/Code Bestellnummer	W (g)		DPC/RRP (Kč/czk)	DPC/RRP (EUR)	EAN13
4CZ-106-13	26350	1	25115,70	1046,49	8592667036666

obsah / content / Inhalt	velikost / size / Größe
1" oválná hlava ráčny / oval ratchet head / Ovale Knarrenkopf	205mm
1" univerzální rukojeť / universal handle / Universal-Knarrengriff	540mm
1" nástavec / extension bar / Verlängerung	200, 400mm
1" hlavice / sockets / Steckschlüssel-Einsatz	42,46,50,55,60,65,70,75,80mm



Kód / Code / Bestellnummer

4CZ-P12

1/2"

Industry
line

CrMo

ISO 2725-2

**POUŽITÍ**

Nabízíme ucelený sortiment utahovacího nářadí. Průmyslové hlavice nástrčné, zástrčné, prodloužené, kardany, prodlužovací nástavce, redukce, adaptéry a další příslušenství - velikosti 1/2". Zá-
těžové ráčny vysoké kvality s revolučním převo-
dem. Průmyslové hlavice nacházejí uplatnění při
profesionálním použití v pneumatických, akumu-
látorových a ze sítě napájených rázových utahová-
cích. Jsou rázuvzdorné, určené pro nejnáročnější
aplikace.

**USABILITY**

We offer a complete range of tightening tools. Im-
pact hex bit and torx sockets, prolonged sockets,
universal joints, extension bars, coupler adaptors,
bit couplers and other accessories - sizes 1/2".
High-quality heavy-duty ratchets with the revo-
lutionary gear. Impact sockets find application in
professional use in pneumatic, battery and power
impact wrenches. They are impact resistant, de-
signed for the most demanding applications.

**VERWENDUNG**

Wir bieten eine umfassende Palette von Handwer-
kzeugen. Schlag-Steckschlüssel, Einsätze, verlän-
gerte Steckschlüssel, Kardangelenke, Verlängerun-
gen, Reduktionen, Adapter und anderes Zubehör
- 1/2". Hochwertige Belastungsknarren mit revo-
lutionärem Getriebe. Schlag-Steckschlüssel
finden Anwendung im professionellen Einsatz
in pneumatischen, Akku-, und netzbetriebenen
Schlagschraubern. Sie sind schlagfest und für die
anspruchsvollsten Anwendung ausgelegt.

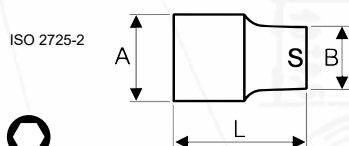

ISO 2725-2
1/2" Hlavice průmyslová Drive CrMo + trn, o-kroužek
1/2" Impact socket Drive CrMo + pin, o-ring
1/2" Schlag-Steckschlüssel Drive CrMo + Dorn, O-Ring

kód/Code Bestellnummer	S (mm)	L (mm)	A (mm)	B (mm)	W (g)		DPC/RRP (Kč/czk)	DPC/RRP (EUR)	EAN13
4CZ-P121-05-08	8	38	25	15	81	10	133,88	5,58	8592667042681
4CZ-P121-05-10	10	38	25	17	81	10	143,80	5,99	8592667042698
4CZ-P121-05-11	11	38	25	19	87	10	149,59	6,23	8592667042704
4CZ-P121-05-12	12	38	25	20	90	10	152,89	6,37	8592667042711
4CZ-P121-05-13	13	38	25	21	90	10	152,89	6,37	8592667042728
4CZ-P121-05-14	14	38	25	22,5	91	10	152,89	6,37	8592667042735
4CZ-P121-05-15	15	38	30	23,5	135	10	152,89	6,37	8592667042742
4CZ-P121-05-16	16	38	30	25	135	10	164,46	6,85	8592667042759
4CZ-P121-05-17	17	38	30	26	135	10	164,46	6,85	8592667042766
4CZ-P121-05-18	18	38	30	27,5	135	10	164,46	6,85	8592667042773
4CZ-P121-05-19	19	38	30	28,5	135	10	164,46	6,85	8592667042780
4CZ-P121-05-21	21	38	30	30,5	135	10	168,60	7,02	8592667042797
4CZ-P121-05-22	22	38	30	32,5	147	10	168,60	7,02	8592667042803
4CZ-P121-05-24	24	38	30	35	152	10	211,57	8,82	8592667042810
4CZ-P121-05-27	27	45	30	38,5	203	10	251,24	10,47	8592667042827
4CZ-P121-05-28	28	45	30	40,2	205	10	291,74	12,16	8592667042834
4CZ-P121-05-30	30	50	30	42	251	10	298,35	12,43	8592667042841
4CZ-P121-05-32	32	50	30	44,2	271	10	311,57	12,98	8592667042858
4CZ-P121-05-32	32	50,0	30,0	44,2	271	10	281,82	11,27	8592667042858

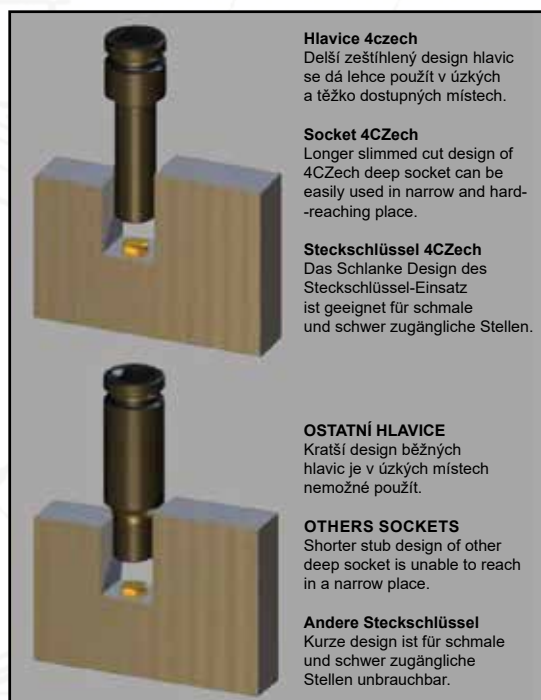
**Hlavice 4czech**

Delší zeštlhý design hlavice se dá lehce použít v úzkých a těžko dostupných místech.

Socket 4Czech

Longer slimmed cut design of 4Czech deep socket can be easily used in narrow and hard-reaching place.

Steckschlüssel 4Czech

Das Schlanke Design des Steckschlüssel-Einsatz ist geeignet für schmale und schwer zugängliche Stellen.

OSTATNÍ HLAVICE

Kratší design běžných hlavice je v úzkých místech nemožné použít.

OTHERS SOCKETS

Shorter stub design of other deep socket is unable to reach in a narrow place.

Andere Steckschlüssel

Kurze design ist für schmale und schwer zugängliche Stellen unbrauchbar.

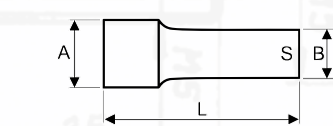

ISO 2725-2

1/2" Hlavice průmyslová prodloužená Drive CrMo + trn, o-kroužek
1/2" Impact socket long type Drive CrMo + pin, o-ring
1/2" Schlag-Steckschlüssel verlängert Drive CrMo + Dorn, O-Ring

kód/Code Bestellnummer	S (mm)	L (mm)	A (mm)	B (mm)	W (g)		DPC/RRP (Kč/czk)	DPC/RRP (EUR)	EAN13
4CZ-P121-06-10	10	80	25	17	140	10	252,07	10,50	8592667042865
4CZ-P121-06-11	11	80	25	18,5	153	10	252,07	10,50	8592667042872
4CZ-P121-06-12	12	80	25	20	158	10	264,46	11,02	8592667038707
4CZ-P121-06-13	13	80	25	21	166	10	263,64	10,98	8592667042889
4CZ-P121-06-14	14	80	25	22,5	177	10	263,64	10,98	8592667042896
4CZ-P121-06-15	15	80	30	22,5	220	10	295,04	12,29	8592667161245
4CZ-P121-06-16	16	80	30	25	236	10	294,21	12,26	8592667042902
4CZ-P121-06-17	17	80	30	26	242	10	294,21	12,26	8592667042919
4CZ-P121-06-18	18	80	30	27,5	253	10	298,35	12,43	8592667042926
4CZ-P121-06-19	19	80	30	28,5	257	10	298,35	12,43	8592667042933
4CZ-P121-06-21	21	80	30	31	284	10	307,44	12,81	8592667042940
4CZ-P121-06-22	22	80	30	32,5	310	10	322,31	13,43	8592667042957
4CZ-P121-06-24	24	80	30	35	350	10	328,10	13,67	8592667042964
4CZ-P121-06-27	27	80	30	38,5	386	10	385,95	16,08	8592667042971
4CZ-P121-06-30	30	80	30	42	435	5	442,98	18,46	8592667042988
4CZ-P121-06-32	32	80	30	44	462	5	462,81	19,28	8592667042995
4CZ-P121-06-32	32	80,0	30,0	44,0	462	5	419,01	16,76	8592667042995



Označené položky jsou dostupné i na závěsném EUROCLIPu.
The marked items are also available in the hang-EUROCLIP.
Markierte Artikel sind auch am hängenden EUROCLIP erhältlich.

Pro objednání se závěsným EUROCLIPem přidejte do objednacího kódu položky písmeno "S" dle vzoru níže.
To order with a hang-EUROCLIP, add the letter "S" to the item number according to the pattern below.
Um mit einem hängenden EUROCLIP zu bestellen, fügen Sie dem Bestellcode des Artikels den Buchstaben "S" gemäß dem untenstehenden Muster hinzu.



4CZ-Pxxx-xx



4CZ-PxxxS-xx

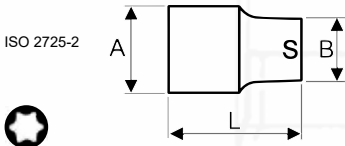

ISO 2725-2
 1/2" Hlavice průmyslová TORX CrMo + trn, o-kroužek
 1/2" Impact socket TORX CrMo + pin, o-ring
 1/2" Industrieinsatz TRX CrMo + Dorn, O-Ring

kód/Code Bestellnummer	S (mm)	L (mm)	A (mm)	B (mm)	W (g)		DPC/RRP (Kč/czk)	DPC/RRP (EUR)	EAN13
4CZ-P121-04-10	E10	38,2	25	15	87	10	185,95	7,75	8592667042612
4CZ-P121-04-12	E12	38,2	25	16,5	89	10	185,95	7,75	8592667042629
4CZ-P121-04-14	E14	38,2	25	18	90	10	185,95	7,75	8592667042636
4CZ-P121-04-16	E16	38,2	25	20	90	10	187,60	7,82	8592667042643
4CZ-P121-04-18	E18	38,2	25	22	91	10	187,60	7,82	8592667042650
4CZ-P121-04-20	E20	38,2	25	25	91	10	196,69	8,20	8592667042667
4CZ-P121-04-24	E24	40	30	30	149	10	209,92	8,75	8592667042674

[Strana 48](#)
[Page 48](#)
[Seite 48](#)

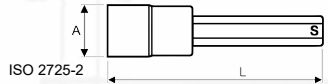

ISO 2725-2
 1/2" Průmyslová zástrčná šestihlanná hlavice CrMo+ trn, o-kroužek
 1/2" Impact socket imbus CrMo + pin, o-ring
 1/2" Schlag-Steckschlüssel-Einsatz 6HR + Dorn, O-Ring

kód/Code Bestellnummer	S (mm)	L (mm)	A (mm)	W (g)		DPC/RRP (Kč/czk)	DPC/RRP (EUR)	EAN13
4CZ-P122-02-05	5	75	25	81	10	287,60	11,98	8592667043008
4CZ-P122-02-06	6	75	25	85	10	287,60	11,98	8592667043015
4CZ-P122-02-08	8	75	25	100	10	287,60	11,98	8592667043022
4CZ-P122-02-10	10	75	25	114	10	287,60	11,98	8592667043039
4CZ-P122-02-12	12	75	25	132	10	322,31	13,43	8592667043046
4CZ-P122-02-14	14	75	25	146	10	322,31	13,43	8592667043053
4CZ-P122-02-17	17	75	25	182	10	372,73	15,53	8592667043060
4CZ-P122-02-19	19	75	25	215	10	406,61	16,94	8592667043077

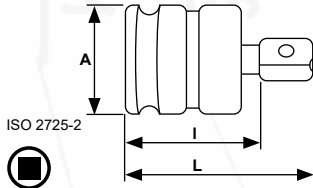

ISO 2725-2
 1/2" Univerzální kardan průmyslový CrMo + trn, o-kroužek
 1/2" Impact universal joint CrMo + pin, o-ring
 - 1/2" Schlag Universal-Kardangelenk CrMo + Dorn, O-Ring

kód/Code Bestellnummer	L (mm)	I (mm)	A (mm)	W (g)		DPC/RRP (Kč/czk)	DPC/RRP (EUR)	EAN13
4CZ-P125-07-60	60	45	30	166	10	680,99	28,37	8592667043114

1/2" O-kroužek
 1/2" O-ring
 1/2" O-Ring

kód/Code Bestellnummer	velikost size(mm)	hlavice (mm)	W (g)		DPC/RRP (Kč/czk)	DPC/RRP (EUR)	EAN13
4CZ-P125-12-4-19	4x19	0-14	1	1	23,72	0,99	8592667109612
4CZ-P125-12-4-24	4x24	15-32	1	1	25,54	1,06	8592667109629

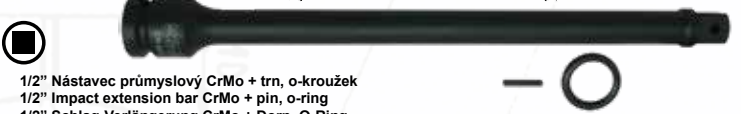
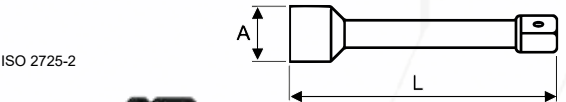

ISO 2725-2
 1/2" Nástavec průmyslový CrMo + trn, o-kroužek
 1/2" Impact extension bar CrMo + pin, o-ring
 1/2" Schlag-Verlängerung CrMo + Dorn, O-Ring

kód/Code Bestellnummer	L (mm)	A (mm)	W (g)		DPC/RRP (Kč/czk)	DPC/RRP (EUR)	EAN13
4CZ-P125-02-075	75	25	136	10	303,31	12,64	8592667043084
4CZ-P125-02-125	125	25	200	10	357,85	14,91	8592667043091
4CZ-P125-02-250	250	25	350	10	466,94	19,46	8592667043107

1/2" Trn
 1/2" Pin
 1/2" Dorn

kód/Code Bestellnummer	velikost size(mm)	hlavice (mm)	W (g)		DPC/RRP (Kč/czk)	DPC/RRP (EUR)	EAN13
4CZ-P125-12-3-20	3x20	0-14	1	1	23,72	0,99	8592667109599
4CZ-P125-12-3-25	3x25	15-32	1	1	25,54	1,06	8592667109605

Kód / Code / Bestellnummer
4CZ-72

1/2" Industry line **CrMo** ISO 2725-2

POUŽITÍ

Rázové nástavce pro demontáž a montáž šroubů či matic kol. Vhodné pro ruční použití i rázový utahovák. Hlavice je dokonale zkalibrována, aby přesně přiléhala, díky čemuž zůstávají hrany šroubů a matic bez poškození i po častém používání. Každá velikost má vlastní barevné plastové rozlišení. Plastový kryt slouží pro ochranu hliníkových ráfků. Tenký, ale pevný profil hlavice zajišťuje pohodlnou práci a vysoký výkon.

USABILITY

Impact sockets for removing and installing wheel bolts or nuts. Suitable for manual use or with impact wrench. The socket is perfectly calibrated to fit exactly, thanks to which the edges of bolts and nuts remain without damage even after frequent use. Each size has its own colored plastic sleeve for easy identification. The plastic cover serves to protect the aluminum rims. The thin but strong profile of the socket ensures the comfortable work and high performance.

VERWENDUNG

Schlagaufsätze zur Demontage und Montage von Radschrauben oder -muttern. Geeignet für Handbetrieb und Schlagschrauber. Schlagaufsätze zur Demontage und Montage von Radschrauben oder -muttern. Geeignet für Handbetrieb und Schlagschrauber. Der Kopf ist perfekt kalibriert und sorgt so für eine präzise Passform, sodass die Kanten von Schrauben und Muttern auch nach häufigem Gebrauch unbeschädigt bleiben. Jede Größe hat ihre eigene farbliche Kunststoffunterscheidung. Die Kunststoffabdeckung dient dem Schutz der Alufelgen. Das dünne, aber starke Profil des Kopfes sorgt für komfortables Arbeiten und hohe Leistung.

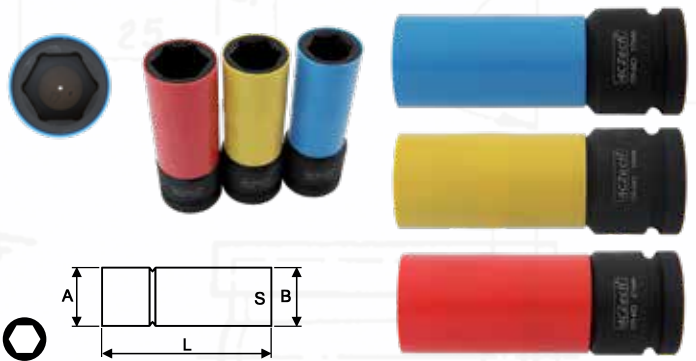

1/2" hlavice nástrčná, na ALU disky kol, délka 85 mm
 1/2" deep impact socket, for aluminium wheel discs, length 85 mm
 1/2" Steckschlüssel, für Alu-Radscheiben, Länge 85 mm

kód/Code Bestellnummer	Barva Color Farbe	S (mm)	L (mm)	A (mm)	B (mm)	W (g)		DPC/RRP (Kč/czk)	DPC/RRP (EUR)	EAN13
4CZ-7217	●	17	85	32,0	28,0	271	50	246,28	10,26	8592667199897
4CZ-7219	●	19	85	32,0	29,0	260	50	246,28	10,26	8592667199903
4CZ-7221	●	21	85	32,0	30,8	273	50	255,37	10,64	8592667199910



1/2" sada hlavic nástrčných 17,0 + 19,0 + 21,0 mm, na ALU disky kol, délka 85 mm
 1/2" deep impact socket set 17,0 + 19,0 + 21,0 mm, for aluminium wheel discs, length 85 mm
 1/2" Steckschlüssel-Satz 17,0 + 19,0 + 21,0 mm, für Alu-Radscheiben, Länge 85 mm

kód/Code Bestellnummer	Barva Color Farbe	S (mm)	W (g)		DPC/RRP (Kč/czk)	DPC/RRP (EUR)	EAN13
4CZ-7290	●●●	17-19-21	958	1	746,28	31,10	8592667199927

Uvedené ceny jsou DPC (doporučené prodejní ceny) v Kč a EUR bez DPH.
 All prices mentioned are DPC (RRP - recommended retail price) in CZK and EUR without VAT.
 Alle Preise sind EV-Preise (empfohlene Verkaufspreise) in CZK und EUR ohne MwSt.



Kód / Code / Bestellnummer

4CZ-P34

3/4"

Industry
line

CrMo

ISO 2725-2



POUŽITÍ

Nabízíme ucelený sortiment utahovacího nářadí. Průmyslové hlavice nástřčné, zástrčné, prodloužené, kardany, prodlužovací nástavce, redukce, adaptéry a další příslušenství - velikosti 3/4". Zátežové ráčny vysoké kvality s revolučním převodem. Průmyslové hlavice nacházejí uplatnění při profesionálním použití v pneumatikách, akumulátorových a ze sítě napájených rázových utahovacích. Jsou rázuvzdorné, určené pro nejnáročnější aplikace.



USABILITY

We offer a complete range of tightening tools. Impact hex bit and torx sockets, prolonged sockets, universal joints, extension bars, coupler adaptors, bit couplers and other accessories - sizes 3/4". High-quality heavy-duty ratchets with the revolutionary gear. Impact sockets find application in professional use in pneumatic, battery and power impact wrenches. They are impact resistant, designed for the most demanding applications.



VERWENDUNG

Wir bieten eine umfassende Palette von Handwerkzeugen. Schlag-Steckschlüssel, Einsätze, verlängerte Steckschlüssel, Kardangelenke, Verlängerungen, Reduktionen, Adapter und anderes Zubehör - 3/4". Hochwertige Belastungsknarren mit revolutionärem Getriebe. Schlag-Steckschlüssel finden Anwendung im professionellen Einsatz in pneumatischen, Akku-, und netzbetriebenen Schlagschraubern. Sie sind schlagfest und für die anspruchsvollsten Anwendungen ausgelegt.

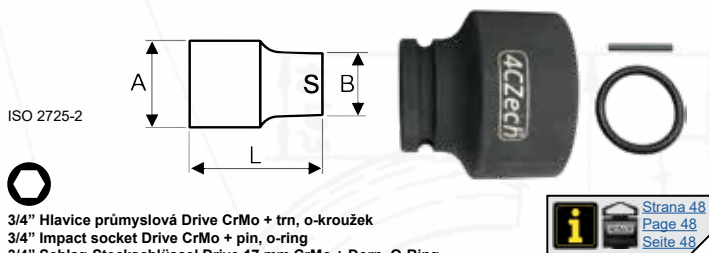

ISO 2725-2

3/4" Hlavice průmyslová Drive CrMo + trn, o-kroužek

3/4" Impact socket Drive CrMo + pin, o-ring

3/4" Schlag-Steckschlüssel Drive 17 mm CrMo + Dorn, O-Ring

 Strana 48
Page 48
Seite 48

kód/Code Bestellnummer	S (mm)	L (mm)	A (mm)	B (mm)	W (g)		DPC/RRP (Kč/czk)	DPC/RRP (EUR)	EAN13
4CZ-P341-05-17	17	51	44	30,1	328	2	264,46	11,02	8592667043121
4CZ-P341-05-19	19	51	44	32,6	328	2	263,64	10,98	8592667043138
4CZ-P341-05-21	21	51	44	25,1	353	2	263,64	10,98	8592667043145
4CZ-P341-05-22	22	51	44	36,1	358	2	271,90	11,33	8592667043152
4CZ-P341-05-24	24	51	44	38,6	371	2	273,55	11,40	8592667043169
4CZ-P341-05-27	27	53	44	42,5	385	2	277,69	11,57	8592667043176
4CZ-P341-05-28	28	53	44	44,0	392	2	277,69	11,57	8592667043183
4CZ-P341-05-29	29	53	44	45,0	400	2	277,69	11,57	8592667043190
4CZ-P341-05-30	30	53	44	46,0	405	2	277,69	11,57	8592667043206
4CZ-P341-05-32	32	57	44	48,5	445	2	287,60	11,98	8592667043213
4CZ-P341-05-33	33	57	44	50,0	472	2	334,71	13,95	8592667043220
4CZ-P341-05-34	34	57	44	51,0	475	2	334,71	13,95	8592667043237
4CZ-P341-05-35	35	57	44	52,5	492	2	364,46	15,19	8592667043244
4CZ-P341-05-36	36	57	44	53,5	503	2	364,46	15,19	8592667043251
4CZ-P341-05-38	38	57	44	56,0	520	2	375,21	15,63	8592667043268
4CZ-P341-05-41	41	58	44	60,0	583	2	477,69	19,90	8592667043275
4CZ-P341-05-42	42	58	44	60,8	572	2	563,64	23,48	8592667043282
4CZ-P341-05-46	46	62	44	66,0	691	2	614,88	25,62	8592667043299

ISO 2725-2

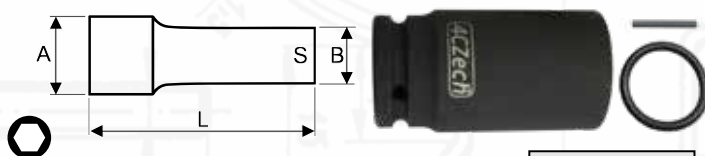

3/4" Hlavice průmyslová prodloužená Drive CrMo + trn, o-kroužek

3/4" Impact socket long type Drive CrMo + pin, o-ring

3/4" Schlag-Steckschlüssel verlängert Drive CrMo + Dorn, O-Ring

 Strana 48
Page 48
Seite 48

kód/Code Bestellnummer	S (mm)	L (mm)	A (mm)	B (mm)	W (g)		DPC/RRP (Kč/czk)	DPC/RRP (EUR)	EAN13
4CZ-P341-06-17	17	90	44	30,8	498	2	559,50	23,31	8592667043305
4CZ-P341-06-19	19	90	44	32,6	524	2	559,50	23,31	8592667043312
4CZ-P341-06-24	24	90	44	38,6	592	2	585,12	24,38	8592667043329
4CZ-P341-06-27	27	90	44	42,5	645	2	583,47	24,31	8592667043336
4CZ-P341-06-30	30	90	44	46,0	699	2	642,15	26,76	8592667043343
4CZ-P341-06-32	32	90	44	48,5	748	2	676,03	28,17	8592667043350
4CZ-P341-06-33	33	90	44	49,2	734	2	775,21	32,30	8592667043367
4CZ-P341-06-36	36	90	44	53,5	841	2	871,07	36,29	8592667043374
4CZ-P341-06-41	41	90	44	56,0	958	2	1030,58	42,94	8592667043381
4CZ-P341-06-46	46	90	44	66,0	1085	1	1221,49	50,90	8592667043398

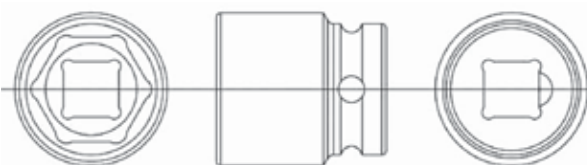

Průmyslové hlavice 4Czech

Vynikající a charakteristické kování umožňuje vytvořit symetrii ve středu hlavice. Jemná struktura je po tepelné úpravě stabilizovaná a zajišťuje nejlepší výkon, snižuje vibrace při pohybu rázového utahováku ve vysokých rychlostech.

Impact socket 4Czech

Distinguished and characteristic forging enable the socket to form the concentricity in the center. Besides, the fine structure of the socket is stabilized after heat treating so as to provide the best performance and lower the vibration when air wrench is moving with high speed RPM.

Schlag-Steckschlüssel 4Czech

Hervorragende und charakteristische schmieden ermöglicht eine genaue Symmetrie in der Mitte des Einsatzes zu erzeugen. Sanfte Struktur ist nach der Thermischen Bearbeitung stabil und besorgt die beste Leistung, vermindert die Vibrationen des Schlagschraubers bei höherer Drehzahl.

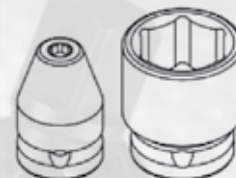

- Vyrobená z vysoce kvalitní chrommolybdenové oceli
- Rádná tepelná úprava
- Fosfátový povrch
- Splňuje normu DIN

- Speciální malý kulatý tvar hrany snižuje vnitřní napětí a zabráňuje poškození hrany šestihřanné matice.

- Special small round corner design can reduce the inner stress and prevent from damaging the corner of hex nut.

- Spezielle runde Kante vermindert innere Spannung und verhindert Beschädigung der Sechskant Schraubenmutter.

- Made of high grade Chrome Molybdenum Steel
- Proper heat treating
- Phosphate finish
- Confirm to DIN standard
- Hergestellt aus dem hoch-Qualität Chrom-Molybdän Eisen
- Ordentliche Thermische Bearbeitung
- Phosphatoberfläche
- Entspricht der DIN Norme



Informace o balení na straně 48
Packing information on page 48
Verpackungsinformationen auf Seite 48

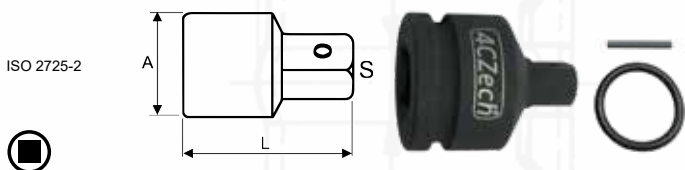

ISO 2725-2
 3/4" - 1/2" Redukce průmyslová CrMo + trn, o-kroužek
 3/4" - 1/2" Impact coupler CrMo + pin, o-ring
 3/4" - 1/2" Schlag-Reduction + Dorn, O-Ring

kód/Code Bestellnummer	S	L (mm)	A (mm)	W (g)		DPC/RRP (Kč/czk)	DPC/RRP (EUR)	EAN13
4CZ-P345-02-120	1/2"	56	44	345	2	692,56	28,86	8592667043404

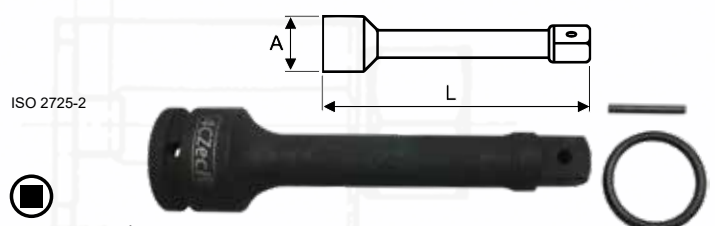

ISO 2725-2
 3/4" Nástavec průmyslový CrMo + trn, o-kroužek
 3/4" Impact Extension bar CrMo + pin, o-ring
 3/4" Schlag-Verlängerung CrMo + Dorn, O-Ring

kód/Code Bestellnummer	L (mm)	A (mm)	W (g)		DPC/RRP (Kč/czk)	DPC/RRP (EUR)	EAN13
4CZ-P345-02-175	175,0	44	766	2	779,34	32,47	8592667043411
4CZ-P345-02-250	250,0	44	997	2	866,12	36,09	8592667043428

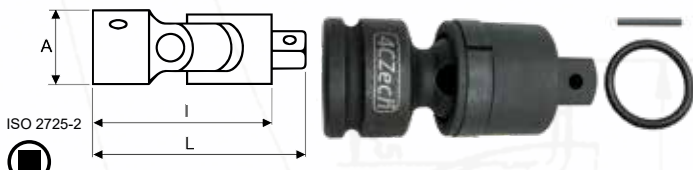

ISO 2725-2
 3/4" Univerzální kardan průmyslový CrMo + trn, o-kroužek
 3/4" Impact universal joint CrMo + pin, o-ring
 3/4" Schlag Universal-Kardangelenk CrMo + Dorn, O-Ring

kód/Code Bestellnummer	L (mm)	I (mm)	A (mm)	W (g)		DPC/RRP (Kč/czk)	DPC/RRP (EUR)	EAN13
4CZ-P345-07-107	107	84	44	749	2	1557,02	64,88	8592667043435



kód/Code Bestellnummer	velikost size(mm)	hlavice (mm)	W (g)		DPC/RRP (Kč/czk)	DPC/RRP (EUR)	EAN13
4CZ-P345-12-4-35	4x35	0-50	1	1	40,17	1,67	8592667109636
4CZ-P345-12-4-45	4x45	54	1	1	40,17	1,67	8592667109643



3/4" O-kroužek
 3/4" O-ring

kód/Code Bestellnummer	velikost size(mm)	hlavice (mm)	W (g)		DPC/RRP (Kč/czk)	DPC/RRP (EUR)	EAN13
4CZ-P345-12-5-36	5x36	0-50	1	1	40,17	1,67	8592667109650
4CZ-P345-12-5-46	5x46	54	1	1	57,02	2,38	8592667109667





Kód / Code / Bestellnummer

4CZ-894

Standard
line

CrV

ISO 1711-1
ISO 691
ISO 3318

DIN 894

ISO 272



POUŽITÍ

Klíče otevřené jednostranné DIN 894 vykované z kvalitní chromvanadiové oceli. Povrchová úprava: bryrnování (černění) pro zlepšení vzhledu i odolnosti proti korozi. Ústí klíče vykloněné o 15° od osy těla klíče (pracovní úhel 30°). V nabídce jsou i sady klíčů ve vinylovém obalu. Nabízíme kvalitu a design bez kompromisu.



USABILITY

Single open end wrench DIN 894 made of quality chrome vanadium steel. Surface finish: bluing (blackening) for design improvement and resistance to corrosion. The leaning angle of the spanner mouth from body axis is 15 degrees (working angle 30 degrees). We also supply spanner sets in a vinyl package. We offer quality and design without compromise.



VERWENDUNG

Einmaulschlüssel DIN 894. Aus hochwertigem Chrom-Vanadium-Stahl geschmiedet. Finish: Brünieren (Schwärzung), um das Aussehen und die Korrosionsbeständigkeit zu verbessern. Usti Schlüssel um 15° von der Achse Tasten Körper (Arbeitswinkel von 30°) gekippt. Es gibt auch eine Reihe von Tasten in einem Kunststoffbeutel. Wir bieten Qualität und Design ohne Kompromisse.

Klíč otevřený jednostranný DIN 894 CrV černěný

Single open end wrench DIN 894 CrV black finish

Einmaulschlüssel DIN 894 CrV brüniert

kód/Code Bestellnummer	S (mm)	L (mm)	A (mm)	B (mm)	W (g)	 DPC/RRP (Kč/cz)	DPC/RRP (EUR)	EAN13
4CZ-894-5.5	5,5	73	3	14	8	10	75,21	3,13 8592667451476
4CZ-894-6	6	73	3	14	8	10	75,21	3,13 8592667451506
4CZ-894-7	7	78	3,5	16	10	10	75,21	3,13 8592667451537
4CZ-894-8	8	94	3,5	18	15	10	75,21	3,13 8592667451568
4CZ-894-9	9	100	4	20	20	10	75,21	3,13 8592667451582
4CZ-894-10	10	104	5	22	25	10	75,21	3,13 8592667451261
4CZ-894-11	11	112	5	24	30	10	75,21	3,13 8592667451278
4CZ-894-12	12	123	5	25	27	10	75,21	3,13 8592667451285
4CZ-894-13	13	132	5,5	28	40	10	81,82	3,41 8592667451292
4CZ-894-14	14	140	6	29	45	10	90,91	3,79 8592667451308
4CZ-894-15	15	145	6	31	53	10	98,35	4,10 8592667451315
4CZ-894-16	16	157	6	36	65	10	120,66	5,03 8592667451322
4CZ-894-17	17	157	6	36	75	10	84,30	3,51 8592667451339
4CZ-894-18	18	170	7	40	90	10	103,31	4,30 8592667451346
4CZ-894-19	19	170	7	40	90	10	103,31	4,30 8592667451353
4CZ-894-21	21	195	8	46	110	10	149,59	6,23 8592667451360
4CZ-894-22	22	195	8	46	110	10	121,49	5,06 8592667451377
4CZ-894-24	24	218	9	51	150	5	161,16	6,71 8592667451384
4CZ-894-27	27	240	10	56	210	5	178,51	7,44 8592667451391
4CZ-894-30	30	265	11	63	265	5	194,21	8,09 8592667451407
4CZ-894-32	32	275	12	67	335	5	219,01	9,13 8592667451414
4CZ-894-34	34	295	12	74	385	5	377,69	15,74 8592667451421
4CZ-894-36	36	295	12	75	390	5	321,49	13,40 8592667451438
4CZ-894-38	38	295	12	75	370	5	440,50	18,35 8592667451445
4CZ-894-41	41	335	14	86	575	5	492,56	20,52 8592667451452
4CZ-894-46	46	365	15	95	690	5	582,64	24,28 8592667451469
4CZ-894-50	50	400	17	102	960	2	629,75	26,24 8592667451483
4CZ-894-55	55	475	17	115	1320	2	844,63	35,19 8592667451490
4CZ-894-60	60	475	18	120	1370	2	1164,46	48,52 8592667451513
4CZ-894-65	65	550	19	131	1650	2	1364,46	56,85 8592667451520
4CZ-894-70	70	550	19	141	1830	2	1653,72	68,90 8592667451544
4CZ-894-75	75	610	21	151	2120	1	2781,82	115,91 8592667451551
4CZ-894-80	80	620	20	157	2150	1	3092,56	128,86 8592667451575

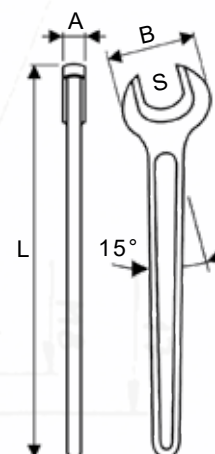

W Hmotnost
Weight
Gewicht



Kód / Code / Bestellnummer

4CZ-895

Standard
line

CrV

ISO 1711-1
ISO 691
ISO 3318

DIN 894

ISO 272



POUŽITÍ

Klíče otevřené oboustranné DIN 895 vykované z kvalitní chromvanadiové oceli. Povrchová úprava: brynění (černění) pro zlepšení vzhledu i odolnosti proti korozi. Ústí klíče vykloněné o 15° od osy těla klíče (pracovní úhel 30°). V nabídce jsou i sady klíčů ve vinylovém obalu. Nabízíme kvalitu a design bez kompromisu.



USABILITY

Double open end spanner DIN 895 made of quality chrome vanadium steel. Surface finish: bluing (blackening) for design improvement and resistance to corrosion. The leaning angle of the spanner mouth from body axis is 15 degrees (working angle 30 degrees). We also supply spanner sets in a vinyl package. We offer quality and design without compromise.



VERWENDUNG

Doppelmaulschlüssel DIN 895. Aus hochwertigem Chrom-Vanadium-Stahl geschmiedet. Finish: Brünieren (Schwärzung), um das Aussehen und die Korrosionsbeständigkeit zu verbessern. Usti Schlüssel um 15° von der Achse Tasten Körper (Arbeitswinkel von 30°) gekippt. Es gibt auch eine Reihe von Tasten in einem Kunststoffbeutel. Wir bieten Qualität und Design ohne Kompromisse.

Klíč otevřený oboustranný DIN 895 CrV černěný
Double open end spanner DIN 895 CrV black finish
Doppelmaulschlüssel DIN 895 CrV brüniert

Kód/Code Bestellnummer	S (mm)	L (mm)	A (mm)	B1 (mm)	B2 (mm)	W (g)	 DPC/RRP (Kč/czk)	DPC/RRP (EUR)	EAN13	
4CZ-895-5.5X7	5,5 x 7	95	3,5	14	16	13	10	49,59	2,07	8592667454132
4CZ-895-6X7	6 x 7	95	3,5	14	16	13	10	49,59	2,07	8592667454156
4CZ-895-6X9	6 x 9	97	3,5	14	17	14	10	50,41	2,10	8592667454163
4CZ-895-7X8	7 x 8	105	3,5	19	20	19	10	49,59	2,07	8592667454170
4CZ-895-8X9	8 x 9	105	3,7	19	20	19	10	49,59	2,07	8592667454194
4CZ-895-8X10	8 x 10	117	4	19	22	27	10	50,41	2,10	8592667454187
4CZ-895-9X10	9 x 10	124	5	22	24	35	10	50,41	2,10	8592667454200
4CZ-895-10X11	10 x 11	124	5	21	23	35	10	50,41	2,10	8592667453876
4CZ-895-10X12	10 x 12	126	5	22	28	40	10	50,41	2,10	8592667453883
4CZ-895-10X13	10 x 13	126	5	21	27	40	10	50,41	2,10	8592667453890
4CZ-895-11X12	11 x 12	126	5	22	27	40	10	50,41	2,10	8592667453906
4CZ-895-12X13	12 x 13	138	5	25	27	45	10	50,41	2,10	8592667453913
4CZ-895-13X14	13 x 14	138	6	28	30	55	10	55,37	2,31	8592667453920
4CZ-895-13X15	13 x 15	150	6	27	31	60	10	55,37	2,31	8592667453937
4CZ-895-13X16	13 x 16	150	6	30	31	60	10	55,37	2,31	8592667453944
4CZ-895-13X17	13 x 17	157	7	30	36	85	10	55,37	2,31	8592667453951
4CZ-895-14X15	14 x 15	150	7	30	31	65	10	58,68	2,44	8592667453968
4CZ-895-14X17	14 x 17	159	7	30	36	85	10	58,68	2,44	8592667453975
4CZ-895-16X18	16 x 18	172	7	36	39	110	10	64,46	2,69	8592667453982
4CZ-895-17X19	17 x 19	172	7	37	40	110	10	64,46	2,69	8592667453999
4CZ-895-18X21	18 x 21	195	8	41	47	170	5	90,08	3,75	8592667454002
4CZ-895-19X22	19 x 22	195	8	41	47	160	5	94,21	3,93	8592667454019
4CZ-895-19X24	19 x 24	210	9	41	50	180	5	134,71	5,61	8592667454026
4CZ-895-22X24	22 x 24	220	9	46	50	220	5	134,71	5,61	8592667454033
4CZ-895-24X27	24 x 27	230	10	50	56	270	5	163,64	6,82	8592667454040
4CZ-895-24X30	24 x 30	270	11	50	64	335	5	190,08	7,92	8592667454057
4CZ-895-27X30	27 x 30	270	12	56	66	400	5	200,83	8,37	8592667454064
4CZ-895-30X32	30 x 32	270	12	64	67	410	5	223,14	9,30	8592667454071
4CZ-895-30X34	30 x 34	275	11	62	67	380	5	286,78	11,95	8592667454088
4CZ-895-32X36	32 x 36	305	12	66	74	500	5	403,31	16,80	8592667454095
4CZ-895-36X41	36 x 41	345	14	79	88	760	3	468,60	19,52	8592667454101
4CZ-895-41X46	41 x 46	380	15	84	96	900	2	604,13	25,17	8592667454118
4CZ-895-46X50	46 x 50	415	17	98	103	1270	2	723,14	30,13	8592667454125
4CZ-895-55X60	55 x 60	480	18	109	121	1890	2	1259,50	52,48	8592667454149

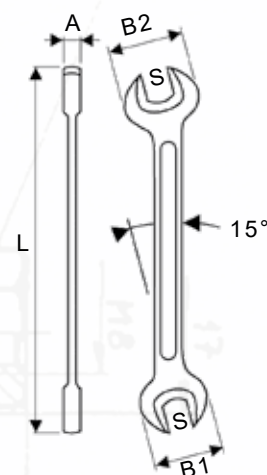

Hmotnost
W Weight
Gewicht



Označené položky jsou dostupné i na blistru.
The marked items are also available in blister packs.
Markierte Artikel sind auch auf Blister erhältlich.

Pro objednání s blistrem přidejte do objednacího kódu položky písmeno "S" dle vzoru níže.
To order with a blister, add the letter "S" to the item number according to the pattern below.
Um mit einem Blister zu bestellen, fügen Sie den Buchstaben „S“ gemäß dem Muster unten zum Bestellcode des Artikels hinzu.





Sada klíčů 7-dílná DIN 895 ve vinylovém pouzdře (5,5x7 - 30x34mm)
7 pcs wrench set DIN 895 in a vinyl pouch (5,5x7 - 30x34,0mm)
7-teiliger Mauschlüsselsatz DIN 895 in Vinylhülle (5,5x7 - 30x34mm)

kód/Code Bestellnummer	W (g)	DPC/RRP (Kč/czk)	DPC/RRP (EUR)	EAN13
4CZ-895-507	1050	1	902,48	8592667566156

obsah / content / Inhalt	velikost / size / Größe
Klíč otevřený oboustranný DIN 895 CrV černěný Double open end spanner DIN 895 CrV black finish Doppelmauschlüssel DIN 895 CrV brüniert	5,5x7 8x10 11x12 13x16 18x21 24x27 30x34 mm

Klíče jsou baleny v praktickém vinylovém obalu opatřeném očky na zavěšení.
Wrenches are packed in a practical vinyl pouch provided with eyelets (opening) for hanging.
Die Schlüssel werden in einem handlichen Gehäuse Vinyl mit Ösen zum Aufhängen versehen verpackt.

Sada klíčů 7-dílná DIN 895 ve vinylovém pouzdře (5,5x7 - 24x27mm)
7 pcs wrench set DIN 895 in a vinyl pouch (5,5x7 - 24x27mm)
7-teiliger Mauschlüsselsatz DIN 895 in Vinylhülle (5,5x7 - 24x27mm)

kód/Code Bestellnummer	W (g)	DPC/RRP (Kč/czk)	DPC/RRP (EUR)	EAN13
4CZ-895-507A	760	1	684,30	8592667507159

obsah / content / Inhalt	velikost / size / Größe
Klíč otevřený oboustranný DIN 895 CrV černěný Double open end spanner DIN 895 CrV black finish Doppelmauschlüssel DIN 895 CrV brüniert	5,5x7 8x10 11x12 13x17 16x18 19x22 24x27 mm



Sada klíčů 12-dílná DIN 895 ve vinylovém pouzdře (5,5-32,0mm)
12 pcs wrench set DIN 895 in a vinyl pouch (5,5-32,0mm)
12-teiliger Mauschlüsselsatz DIN 895 in Vinylhülle (5,5x7 - 30x32mm)

kód/Code Bestellnummer	W (g)	DPC/RRP (Kč/czk)	DPC/RRP (EUR)	EAN13
4CZ-895-512	1700	1	1314,05	8592667454149

obsah / content / Inhalt	velikost / size / Größe
Klíč otevřený oboustranný DIN 895 CrV černěný / Double open end spanner DIN 895 CrV black finish / Doppelmauschlüssel DIN 895 CrV brüniert	5,5x7 6x9 8x10 11x12 13x16 14x15 14x17 18x21 19x22 24x27 24x30 30x32 mm

Klíče jsou baleny v praktickém vinylovém obalu opatřeném očky na zavěšení.
Wrenches are packed in a practical vinyl pouch provided with eyelets (opening) for hanging.
Die Schlüssel werden in einem handlichen Gehäuse Vinyl mit Ösen zum Aufhängen versehen verpackt.



Demovůz NÁSTROJE CZ, s.r.o. je vybavený vrtáčkou FLOTT.

The demonstration vehicle NÁSTROJE CZ, s.r.o. is equipped with the drill FLOTT.

Der Demowagen von NÁSTROJE CZ, s.r.o. ist mit einer FLOTT-Bohrmaschine ausgestattet.



Demovůz NÁSTROJE CZ, s.r.o. může být i u Vás, kontaktujte svého obchodního zástupce.

Sales representatives can come with the demonstration vehicle NÁSTROJE CZ, s.r.o. to your company, contact them.

Der Demowagen von NÁSTROJE CZ, s.r.o. kann auch bei Ihnen sein, kontaktieren Sie Ihren Geschäftsvertreter.



Kód / Code / Bestellnummer

4CZ-600

Industry
line

CrV

ISO 691
ISO 1711-1
ISO 3318
ISO 10102

DIN
3110



POUŽITÍ

Klíč oboustranný otevřený DIN 3110 vykovany z jednoho kusu kvalitní chromvanadiové oceli. Povrchová úprava: chromovaný leštěný povrch. Ústí klíče vykloněné o 15° od osy těla klíče (pracovní úhel 30°). V nabídce jsou i sady klíčů ve vinylovém obalu. Nabízíme kvalitu a design bez kompromisu.



USABILITY

Double-ended wrench DIN 3110 forged from one piece of high grade chrome-vanadium steel. Surface finish: chrome-plated polished surface. Spanner's mouth at 15° offset (working angle 30°). We also offer spanner sets in vinyl pouch packing. We offer quality and design without compromise.



VERWENDUNG

Doppelmaulschlüssel DIN 3110 geschmiedet aus einem Chromvanadiumguss. Oberfläche: Poliertes Chrom. Schlüssel ende geknickt um 15° vom Schlüsselkörper (Arbeit Winkel 30°). Es gibt auch eine Reihe von Tasten in einem Kunststoffbeutel. Wir bieten Qualität und Design ohne Kompromisse.

Oboustranný klíč DIN 3110 chromovaný
Double-ended wrench DIN 3110 chromium-plated
Doppelmaulschlüssel DIN 3110 verchromt

kód/Code Bestellnummer	S (mm)	L (mm)	A1 (mm)	A2 (mm)	B1 (mm)	B2 (mm)	W (g)		DPC/RRP (Kč/czk)	DPC/RRP (EUR)	EAN13
4CZ-600-4X5	4 x 5	101	3,5	3,5	10,8	12,5	12	10	96,69	4,03	8592667108578
4CZ-600-6X7	6 x 7	120	4,1	4,2	15,2	17,3	24	10	96,69	4,03	8592667108585
4CZ-600-8X9	8 x 9	141	4,6	4,7	18,5	21,2	38	10	102,48	4,27	8592667108608
4CZ-600-8X10	8 x 10	141	4,6	4,7	18,5	21,2	38	10	102,48	4,27	8592667108592
4CZ-600-10X11	10 x 11	156	4,9	4,9	22,8	25,0	50	10	106,61	4,44	8592667108288
4CZ-600-10X12	10 x 12	156	5,0	5,0	21,6	24,3	50	10	119,01	4,96	8592667108295
4CZ-600-10X13	10 x 13	171	5,2	5,2	24,5	27,7	64	10	125,62	5,23	8592667121331
4CZ-600-11X13	11 x 13	171	5,5	5,7	24,3	27,8	68	10	119,83	4,99	8592667108301
4CZ-600-12X13	12 x 13	171	5,5	5,5	27,1	30,0	76	10	119,83	4,99	8592667108318
4CZ-600-12X14	12 x 14	171	5,0	5,3	26,4	29,0	68	10	129,75	5,41	8592667108325
4CZ-600-13X17	13 x 17	190	6,3	6,3	31,2	36,6	118	10	143,80	5,99	8592667108332
4CZ-600-14X15	14 x 15	186	6,2	6,2	31,3	33,0	102	10	143,80	5,99	8592667108349
4CZ-600-14X17	14 x 17	190	6,2	6,2	31,8	37,0	108	10	145,45	6,06	8592667108356
4CZ-600-16X17	16 x 17	220	6,8	6,8	34,7	37,2	134	10	150,41	6,27	8592667108363
4CZ-600-16X18	16 x 18	220	6,8	6,8	35,0	37,7	138	10	162,81	6,78	8592667108370
4CZ-600-17X19	17 x 19	220	6,8	6,9	39,1	41,6	168	10	164,46	6,85	8592667108387
4CZ-600-18X19	18 x 19	220	6,8	6,8	39,1	41,3	164	10	167,77	6,99	8592667108394
4CZ-600-19X22	19 x 22	237	7,4	7,6	42,6	45,7	214	10	186,78	7,78	8592667108400
4CZ-600-20X22	20 x 22	237	7,4	7,6	42,8	47,3	214	10	196,69	8,20	8592667108417
4CZ-600-21X23	21 x 23	245	7,9	7,9	45,2	49,5	248	10	221,49	9,23	8592667108424
4CZ-600-22X24	22 x 24	250	8,1	8,1	47,3	52,0	276	5	227,27	9,47	8592667108431
4CZ-600-24X26	24 x 26	260	8,9	8,6	52,3	56,6	358	5	301,65	12,57	8592667108448
4CZ-600-24X27	24 x 27	260	8,9	8,6	52,0	56,8	348	5	301,65	12,57	8592667108455
4CZ-600-25X28	25 x 28	270	9,6	9,7	53,0	58,5	408	5	317,36	13,22	8592667108462
4CZ-600-26X28	26 x 28	270	8,9	8,9	53,3	58,7	358	5	346,28	14,43	8592667108479
4CZ-600-27X29	27 x 29	280	9,3	9,3	57,3	63,5	446	5	346,28	14,43	8592667108486
4CZ-600-27X30	27 x 30	280	9,1	9,1	56,8	63,0	424	5	351,24	14,63	8592667108493
4CZ-600-30X32	30 x 32	295	9,3	9,3	63,1	66,8	506	5	377,69	15,74	8592667108509
4CZ-600-33X35	33 x 35	348	10,7	10,7	62,1	75,2	655	3	692,56	28,86	8592667108516
4CZ-600-34X36	34 x 36	348	10,7	10,7	62,1	75,2	982	3	692,56	28,86	8592667108523
4CZ-600-36X41	36 x 41	414	12,8	12,8	71,7	82,4	982	2	961,16	40,05	8592667108530
4CZ-600-38X42	38 x 42	414	12,8	12,8	71,7	82,4	937	2	990,91	41,29	8592667108547
4CZ-600-41X46	41 x 46	452	15,4	15,4	82,0	90,7	1456	1	1643,80	68,49	8592667108554
4CZ-600-46X50	46 x 50	507	16,5	16,5	90,7	99,4	2066	1	2230,58	92,94	8592667108561

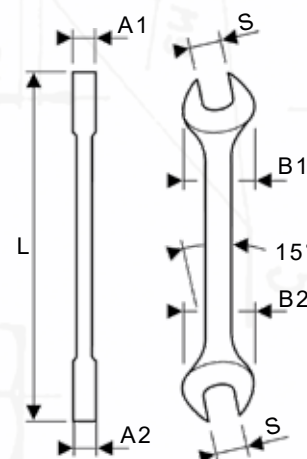

W Hmotnost
Weight
Gewicht





Sada klíčů 8-dílná DIN 3110 ve vinylovém pouzdře (4x5 - 18x19mm)
8 pcs wrench set DIN 3110 in a vinyl pouch (4x5 - 18x19mm)
8-teiliger Schlüsselsatz DIN 3110 in Vinyelhülle (4x5 - 18x19mm)

kód/Code Bestellnummer	W (g)	1	DPC/RRP (Kč/czk)	DPC/RRP (EUR)	EAN13
4CZ-600-508	680	1	1144,63	47,69	8592667109407

Klíče jsou baleny v praktickém vinylovém obalu opatřeném očky na zavěšení.
Wrenches are packed in a practical vinyl pouch provided with eyelets (opening) for hanging.
Die Schlüssel werden in einem handlichen Gehäuse Vinyl mit Ösen zum Aufhängen versehen verpackt.

obsah / content / Inhalt	velikost / size / Größe
Oboustranný klíč DIN 3110 chromovaný / Double-ended wrench DIN 3110 chromium-plated / Doppelmaulschlüssel DIN 3110 verchromt	4 x 5; 6 x 7; 8 x 9; 10 x 11; 12 x 13; 14 x 15; 16 x 17; 18 x 19 mm



Sada klíčů 12-dílná DIN 3110 ve vinylovém pouzdře (6x7 - 30x32mm)
12 pcs wrench set DIN 3110 in a vinyl pouch (6x7 - 30x32mm)
12-teiliger Schlüsselsatz DIN 3110 in Vinyelhülle (6x7 - 30x32mm)

kód/Code Bestellnummer	W (g)	1	DPC/RRP (Kč/czk)	DPC/RRP (EUR)	EAN13
4CZ-600-512	2600	1	2613,22	108,88	8592667109414

obsah / content / Inhalt	velikost / size / Größe
Oboustranný klíč DIN 3110 chromovaný / Double-ended wrench DIN 3110 chromium-plated / Doppelmaulschlüssel DIN 3110 verchromt	6 x 7; 8 x 9; 10 x 11; 12 x 13; 14 x 15; 16 x 17; 18 x 19; 21 x 23; 22 x 24; 26 x 28; 27 x 29; 30 x 32 mm



Kód / Code / Bestellnummer

4CZ-277

Industry
line

CrV

ISO 691
ISO 1711-1
ISO 3318
ISO 7738

DIN
3113



POUŽITÍ

Klíč očkoplochý DIN 3113 vykováný z jednoho kusu kvalitní chromvanadiové oceli. Povrchová úprava: chromovaný leštěný povrch. 12ti hranné očko vykloněné o 15° od osy těla klíče (pracovní úhel 30°). Profil očka zajišťuje maximální styčnou plochu přenosu síly na matice pro prodloužení životnosti klíče. V nabídce jsou i sady klíčů ve vinylovém obalu. Nabízíme kvalitu a design bez kompromisu.



USABILITY

Combination wrench DIN 3113 forged from one piece of high grade chrome-vanadium steel. Surface finish: chrome-plated surface. Bi-hexagonal ring at 15° offset (working angle 30°). The ring profile provides maximum contact and transfers power on nuts in order to extend lifetime of spanners. We also offer spanner sets in vinyl pouch packing. We offer quality and design without compromise.



VERWENDUNG

Ring-Maulschlüssel DIN 3113 geschmiedet aus einem Chromvanadiumguss. Oberfläche: Poliertes Chrom. 12-Kantige Ring geknickt um 15° vom Schlüsselkörper (Arbeit Winkel 30°). Profil des Ringes sichert maximale Kraftfläche auf die Mutter für Verlängerung der Lebensdauer des Schlüssels. Es gibt auch eine Reihe von Tasten in einem Kunststoffbeutel. Wir bieten Qualität und Design ohne Kompromisse.

Očkoplochý klíč DIN 3113 chromovaný
Combination wrench DIN 3113 chromium-plated
Ring-Maulschlüssel DIN 3113 verchromt

kód/Code Bestellnummer	S (mm)	L (mm)	A1 (mm)	A2 (mm)	B1 (mm)	B2 (mm)	W (g)		DPC/RRP (Kč/czk)	DPC/RRP (EUR)	EAN13
4CZ-277-5	5	110	4,3	4,8	14,5	11,2	20	10	93,39	3,89	8592667108189
4CZ-277-5.5	5,5	110	4,3	5,1	15,0	11,2	20	10	93,39	3,89	8592667108196
4CZ-277-6	6	110	4,1	4,6	14,3	11,2	20	10	96,69	4,03	8592667108226
4CZ-277-7	7	120	4,3	5,5	16,7	12,1	22	10	96,69	4,03	8592667108257
4CZ-277-8	8	130	4,6	5,8	18,3	13,5	26	10	96,69	4,03	8592667108264
4CZ-277-9	9	140	5,0	6,5	20,2	15,0	34	10	96,69	4,03	8592667108271
4CZ-277-10	10	150	5,5	6,9	21,9	16,1	44	10	99,17	4,13	8592667107908
4CZ-277-11	11	160	5,5	7,2	24,2	17,3	48	10	99,17	4,13	8592667107915
4CZ-277-12	12	170	5,5	7,2	26,0	18,9	60	10	100,83	4,20	8592667107922
4CZ-277-13	13	180	6,0	8,2	28,1	20,4	74	10	106,61	4,44	8592667107939
4CZ-277-14	14	190	6,0	8,5	30,6	22,0	86	10	116,53	4,86	8592667107946
4CZ-277-15	15	200	6,5	9,6	32,4	23,2	100	10	126,45	5,27	8592667107953
4CZ-277-16	16	210	6,5	9,7	34,6	24,9	114	10	138,84	5,79	8592667107960
4CZ-277-17	17	220	6,5	9,7	36,4	25,7	124	10	142,15	5,92	8592667107977
4CZ-277-18	18	230	7,0	11,0	38,1	27,5	154	10	152,89	6,37	8592667107984
4CZ-277-19	19	240	7,7	11,0	40,4	28,0	172	10	162,81	6,78	8592667107991
4CZ-277-20	20	250	7,7	11,6	42,0	29,7	180	10	177,69	7,40	8592667108004
4CZ-277-21	21	260	8,3	11,7	43,9	31,1	228	10	186,78	7,78	8592667108011
4CZ-277-22	22	270	8,3	11,3	46,0	32,3	238	10	200,83	8,37	8592667108028
4CZ-277-23	23	280	8,7	12,8	47,5	34,0	290	10	214,05	8,92	8592667108035
4CZ-277-24	24	290	8,6	13,0	50,7	35,4	294	10	227,27	9,47	8592667108042
4CZ-277-25	25	300	9,0	13,5	51,9	36,3	328	10	271,07	11,29	8592667108059
4CZ-277-26	26	315	9,4	14,0	54,2	38,0	374	5	277,69	11,57	8592667108066
4CZ-277-27	27	320	9,4	15,0	56,8	39,8	404	5	296,69	12,36	8592667108073
4CZ-277-28	28	320	9,8	15,0	58,5	41,1	432	5	332,23	13,84	8592667108080
4CZ-277-29	29	340	10,1	15,0	60,0	42,0	466	5	346,28	14,43	8592667108097
4CZ-277-30	30	350	10,4	15,2	61,8	43,6	508	5	346,28	14,43	8592667108103
4CZ-277-32	32	370	11,0	15,4	65,7	46,3	604	5	388,43	16,18	8592667108110
4CZ-277-34	34	400	12,7	18,7	64,2	47,8	658	5	829,75	34,57	8592667108127
4CZ-277-36	36	430	14,3	19,8	68,7	51,8	833	5	961,16	40,05	8592667108134
4CZ-277-38	38	460	16,0	20,9	71,5	54,8	995	3	1191,74	49,66	8592667108141
4CZ-277-41	41	490	17,1	22,0	78,0	59,7	1300	3	1392,56	58,02	8592667108158
4CZ-277-46	46	550	19,1	25,3	85,9	69,2	1700	3	1787,60	74,48	8592667108165
4CZ-277-48	48	570	19,9	26,4	89,7	72,2	1850	2	2259,50	94,15	8592667108172
4CZ-277-50	50	590	20,8	27,5	93,4	75,2	2250	2	2527,27	105,30	8592667108202
4CZ-277-55	55	650	22,8	30,3	102,0	82,7	3000	2	4586,78	191,12	8592667108219
4CZ-277-60	60	710	24,9	33,0	112,0	90,0	3330	1	5532,23	230,51	8592667108233
4CZ-277-65	65	770	27,0	35,8	121,0	97,0	4000	1	6180,17	257,51	8592667108240
4CZ-277-70	70	670	24,0	31,0	140,0	110,0	4500	1	6657,02	277,38	8592667507166

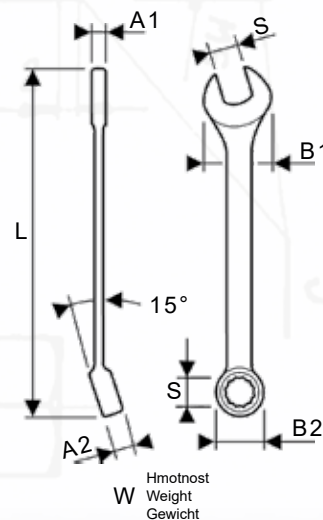
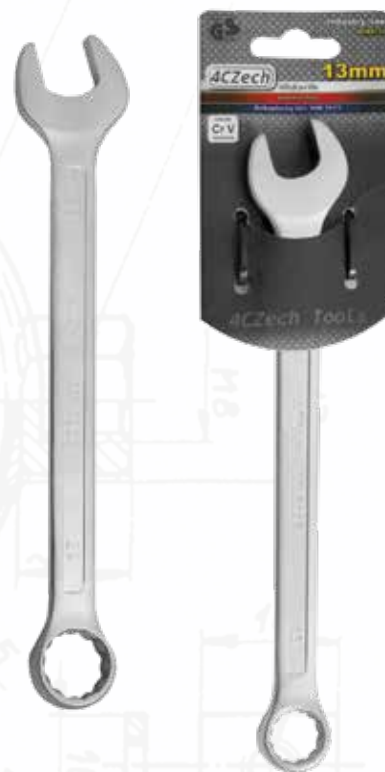



Sada klíčů 8-dílná DIN 3113 ve vinylovém pouzdře (8 - 24mm)
8 pcs wrench set DIN 3113 in a vinyl pouch (8 - 24mm)
8-teiliger Schlüsselsatz DIN 3113 in Vinylhülle (8 - 24mm)

kód/Code Bestellnummer	W (g)		DPC/RRP (Kč/czk)	DPC/RRP (EUR)	EAN13
4CZ-277-508	1150	1	1310,74	54,61	8592667109377

Klíče jsou baleny v praktickém vinylovém obalu opatřeném očky na zavěšení.
Wrenches are packed in a practical vinyl pouch provided with eyelets (opening) for hanging.
Die Schlüssel werden in einem handlichen Gehäuse Vinyl mit Ösen zum Aufhängen versehen verpackt.

obsah / content / Inhalt	velikost / size / Größe
Očkoplochý klíč DIN 3113 chromovaný / Combination wrench DIN 3113 chromium-plated / Ring-Maulschlüssel DIN 3113 verchromt	8 ; 10 ; 11 ; 13 ; 17 ; 19 ; 22 ; 24 mm

Sada klíčů 12-dílná DIN 3113 ve vinylovém pouzdře (7 - 24mm)
12 pcs wrench set DIN 3113 in a vinyl pouch (7 - 24mm)
12-teiliger Schlüsselsatz DIN 3113 in Vinylhülle (7 - 24mm)

kód/Code Bestellnummer	W (g)		DPC/RRP (Kč/czk)	DPC/RRP (EUR)	EAN13
4CZ-277-512	1550	1	1829,75	76,24	8592667109384



obsah / content / Inhalt	velikost / size / Größe
Očkoplochý klíč DIN 3113 chromovaný / Combination wrench DIN 3113 chromium-plated / Ring-Maulschlüssel DIN 3113 verchromt	7 ; 8 ; 10 ; 11 ; 12 ; 13 ; 16 ; 17 ; 18 ; 19 ; 22 ; 24 mm

Sada klíčů 16-dílná DIN 3113 ve vinylovém pouzdře (8 - 24mm)
16 pcs wrench set DIN 3113 in a vinyl pouch (8 - 24mm)
16-teiliger Schlüsselsatz DIN 3113 in Vinylhülle (8 - 24mm)

kód/Code Bestellnummer	W (g)		DPC/RRP (Kč/czk)	DPC/RRP (EUR)	EAN13
4CZ-277-516	2200	1	2467,77	102,82	8592667123960



obsah / content / Inhalt	velikost / size / Größe
Očkoplochý klíč DIN 3113 chromovaný / Combination wrench DIN 3113 chromium-plated / Ring-Maulschlüssel DIN 3113 verchromt	8 ; 9 ; 10 ; 11 ; 12 ; 13 ; 14 ; 15 ; 16 ; 17 ; 18 ; 19 ; 20 ; 21 ; 22 ; 24 mm

Sada klíčů 22-dílná DIN 3113 ve vinylovém pouzdře (6 - 32mm)
22 pcs wrench set DIN 3113 in a vinyl pouch (6 - 32mm)
22-teiliger Schlüsselsatz DIN 3113 in Vinylhülle (6 - 32mm)

kód/Code Bestellnummer	W (g)		DPC/RRP (Kč/czk)	DPC/RRP (EUR)	EAN13
4CZ-277-522	4300	1	4171,07	173,79	8592667109391



obsah / content / Inhalt	velikost / size / Größe
Očkoplochý klíč DIN 3113 chromovaný / Combination wrench DIN 3113 chromium-plated / Ring-Maulschlüssel DIN 3113 verchromt	6 ; 7 ; 8 ; 9 ; 10 ; 11 ; 12 ; 13 ; 14 ; 15 ; 16 ; 17 ; 18 ; 19 ; 20 ; 21 ; 22 ; 24 ; 26 ; 27 ; 30 ; 32 mm



Kód / Code / Bestellnummer

4CZ-277R

Industry
line

CrV

ISO 691
ISO 1711-1

ASME
B107.100



POUŽITÍ

Klíč očkoplochý ráčnový s přepínací páčkou ISO1711-1 vykovány z jednoho kusu kvalitní chromvanadiové oceli. Povrchová úprava: chromovaný leštěný povrch. 12ti hranné očko vykloněné o 15° od osy těla klíče (pracovní úhel 30°). Profil očka zajišťuje maximální styčnou plochu přenosu síly na matice pro prodloužení životnosti klíče. V nabídce jsou i sady klíčů ve vinylovém obalu. Nabízíme kvalitu a design bez kompromisu.



USABILITY

Combination ratchet wrench with switcher ISO1711-1 forged from one piece of high grade chrome-vanadium steel. Surface finish: chrome-plated surface. Bi-hexagonal ring at 15° offset (working angle 30°). The ring profile provides maximum contact and transfers power on nuts in order to extend lifetime of spanners. We also offer spanner sets in vinyl pouch packing. We offer quality and design without compromise.



VERWENDUNG

Knarren-Ring-Maulschlüssel mit Umschalhebel ISO1711-1 geschmiedet aus einem Chromvanadiumguss. Oberfläche: Poliertes Chrom. 12-Kantige Ring geknickt um 15° vom Schlüsselkörper (Arbeit Winkel 30°). Profil des Ringes sichert maximale Kraftfläche auf die Mutter für Verlängerung der Lebensdauer des Schlüssels. Es gibt auch eine Reihe von Tasten in einem Kunststoffbeutel. Wir bieten Qualität und Design ohne Kompromisse.

Očkoplochý klíč ráčnový s přepínací páčkou ISO1711-1 chromovaný
Combination ratchet wrench with switcher ISO1711-1 chromium-plated
Knarren-Ring-Maulschlüssel mit Umschalhebel ISO1711-1 verchromt

kód/Code Bestellnummer	S (mm)	L (mm)	A1 (mm)	A2 (mm)	B1 (mm)	B2 (mm)	W (g)		DPC/RRP (Kč/czk)	DPC/RRP (EUR)	EAN13
4CZ-277R-8	8	140	5,3	6,5	17,3	18,5	38	10	303,31	12,64	8592667139480
4CZ-277R-9	9	150	5,5	7,2	20,0	19,8	44	10	303,31	12,64	8592667139497
4CZ-277R-10	10	159	6,4	7,7	23,0	21,3	63	10	327,27	13,64	8592667139329
4CZ-277R-11	11	165	6,7	8,2	24,5	24,0	73	10	338,84	14,12	8592667139336
4CZ-277R-12	12	171	7,1	8,6	26,7	24,4	82	10	338,84	14,12	8592667139343
4CZ-277R-13	13	178	7,6	9,0	27,6	26,7	103	10	357,85	14,91	8592667139350
4CZ-277R-14	14	191	7,7	9,4	31,8	28,2	118	10	395,04	16,46	8592667139367
4CZ-277R-15	15	200	7,8	9,9	32,6	30,5	135	10	395,04	16,46	8592667139374
4CZ-277R-16	16	209	8,4	10,3	34,7	31,9	158	10	457,85	19,08	8592667139381
4CZ-277R-17	17	225	8,9	10,7	36,7	33,5	185	10	457,85	19,08	8592667139398
4CZ-277R-18	18	237	9,9	11,2	37,4	35,2	228	10	488,43	20,35	8592667139404
4CZ-277R-19	19	245	10,0	11,2	41,9	35,9	251	10	507,44	21,14	8592667139411
4CZ-277R-20	20	289	10,0	13,0	45,1	41,8	373	10	613,22	25,55	8592667139428
4CZ-277R-21	21	289	10,0	13,0	45,1	41,8	344	10	626,45	26,10	8592667139435
4CZ-277R-22	22	289	10,0	13,0	45,1	41,8	366	10	635,54	26,48	8592667139442
4CZ-277R-23	23	331	11,0	14,6	51,5	48,8	552	10	646,28	26,93	8592667139459
4CZ-277R-24	24	331	11,0	14,6	51,1	49,3	563	10	719,83	29,99	8592667139466
4CZ-277R-25	25	331	11,0	14,6	52,0	48,7	530	10	784,30	32,68	8592667139473
4CZ-277R-27	27	325	11,1	16,3	54,3	51,5	607	10	1164,46	48,52	8592667191983
4CZ-277R-30	30	345	11,8	17,3	57,6	58,9	754	10	1318,18	54,92	8592667191990
4CZ-277R-32	32	390	12,7	17,4	62,0	60,2	854	10	1522,31	63,43	8592667192003

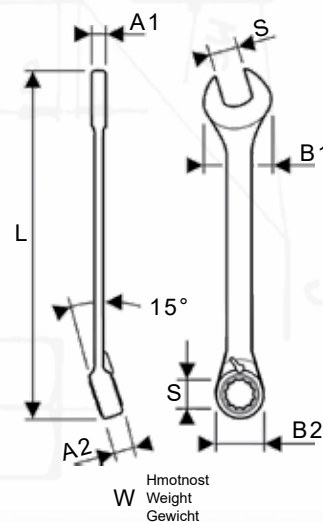



Klíče jsou baleny v praktickém vinylovém obalu opatřeném očky na zavěšení.
Wrenches are packed in a practical vinyl pouch provided with eyelets (opening) for hanging.
Die Schlüssel werden in einem handlichen Gehäuse Vinyl mit Ösen zum Aufhängen versehen verpackt.

Sada klíčů 8-dílná ISO1711-1 ve vinylovém pouzdře (8 - 24mm)
8 pcs wrench set ISO1711-1 in a vinyl pouch (8 - 24mm)
8-teiliger Knarren-Ring-Maulschlüsselsatz ISO1711-1 in Vinylhülle (8 - 24mm)

kód/Code Bestellnummer	typ/type	obsah/content Inhalt	W (g)		DPC/RRP (Kč/cz)	DPC/RRP (EUR)	EAN13
4CZ-277R-508	ISO1711-1	8 - 24 mm	1750	1	3824,79	159,37	8592667158559

obsah / content / Inhalt	velikost / size / Größe
Očkoplochý klíč ráčnový s přepínací páčkou ISO1711-1 chromovaný / Combination ratchet wrench with switcher ISO1711-1 chromium-plated / Knarren-Ring-Maulschlüssel mit Umschalthebel ISO1711-1 verchromt	8 ; 10 ; 11 ; 13 ; 17 ; 19 ; 22 ; 24 mm

8dílná sada klíčů s př.páčkou vy.15°, ISO1711-1 (8 - 19mm) ve vinylovém pouzdře
8 pcs wrench set with switcher ISO1711-1 in a vinyl pouch (8 - 19mm)
8-teiliger Knarren-Ring-Maulschlüsselsatz ISO1711-1 in Vinylhülle (8 - 19mm)

kód/Code Bestellnummer	typ/type	obsah/content Inhalt	W (g)		DPC/RRP (Kč/cz)	DPC/RRP (EUR)	EAN13
4CZ-277R-508A	ISO1711-1	8 - 19 mm	1236	1	3471,07	144,63	8592667655515

obsah / content / Inhalt	velikost / size / Größe
Očkoplochý klíč ráčnový s přepínací páčkou ISO1711-1 chromovaný / Combination ratchet wrench with switcher ISO1711-1 chromium-plated / Knarren-Ring-Maulschlüssel mit Umschalthebel ISO1711-1 verchromt	8 ; 10 ; 13 ; 15 ; 16 ; 17 ; 18 ; 19 mm

Sada klíčů 12-dílná ISO1711-1 ve vinylovém pouzdře (8 - 24mm)
12 pcs wrench set ISO1711-1 in a vinyl pouch (8 - 24mm)
12-teiliger Knarren-Ring-Maulschlüsselsatz ISO1711-1 in Vinylhülle (8 - 24mm)

kód/Code Bestellnummer	typ/type	obsah/content Inhalt	W (g)		DPC/RRP (Kč/cz)	DPC/RRP (EUR)	EAN13
4CZ-277R-512	ISO1711-1	8 - 24 mm	2300	1	5441,32	226,72	8592667158566

obsah / content / Inhalt	velikost / size / Größe
Očkoplochý klíč ráčnový s přepínací páčkou ISO1711-1 chromovaný / Combination ratchet wrench with switcher ISO1711-1 chromium-plated / Knarren-Ring-Maulschlüssel mit Umschalthebel ISO1711-1 verchromt	8 ; 9 ; 10 ; 11 ; 12 ; 13 ; 16 ; 17 ; 18 ; 19 ; 22 ; 24 mm

12dílná sada klíčů s př.páčkou vy.15°, ISO1711-1 (8 - 19mm) ve vinylovém pouzdře
12 pcs wrench set with switcher ISO1711-1 in a vinyl pouch (8 - 19mm)
12-teiliger Knarren-Ring-Maulschlüsselsatz ISO1711-1 in Vinylhülle (8 - 19mm)

kód/Code Bestellnummer	typ/type	obsah/content Inhalt	W (g)		DPC/RRP (Kč/cz)	DPC/RRP (EUR)	EAN13
4CZ-277R-512A	ISO1711-1	8 - 19 mm	1605	1	4876,03	203,17	8592667655546

obsah / content / Inhalt	velikost / size / Größe
Očkoplochý klíč ráčnový s přepínací páčkou ISO1711-1 chromovaný / Combination ratchet wrench with switcher ISO1711-1 chromium-plated / Knarren-Ring-Maulschlüssel mit Umschalthebel ISO1711-1 verchromt	8 ; 9 ; 10 ; 11 ; 12 ; 13 ; 14 ; 15 ; 16 ; 17 ; 18 ; 19 mm

Sada klíčů 16-dílná ISO1711-1 ve vinylovém pouzdře (8 - 24mm)
16 pcs wrench set ISO1711-1 in a vinyl pouch (8 - 24mm)
16-teiliger Knarren-Ring-Maulschlüsselsatz ISO1711-1 in Vinylhülle (8 - 24mm)

kód/Code Bestellnummer	typ/type	obsah/content Inhalt	W (g)		DPC/RRP (Kč/cz)	DPC/RRP (EUR)	EAN13
4CZ-277R-516	ISO1711-1	8 - 24 mm	3300	1	7501,65	312,57	8592667158573

obsah / content / Inhalt	velikost / size / Größe
Očkoplochý klíč ráčnový s přepínací páčkou ISO1711-1 chromovaný / Combination ratchet wrench with switcher ISO1711-1 chromium-plated / Knarren-Ring-Maulschlüssel mit Umschalthebel ISO1711-1 verchromt	8 ; 9 ; 10 ; 11 ; 12 ; 13 ; 14 ; 15 ; 16 ; 17 ; 18 ; 19 ; 20 ; 21 ; 22 ; 24 mm



Kód / Code / Bestellnummer

4CZ-278RK

Industry
line

CrV

ISO 691
ISO 1711-1

ASME
B107.100



POUŽITÍ

S inovativním designem 74 zubů a jeho vylepšenou strukturou lze použít za obtížných podmínek. 12hranné očko na kloubovém čepu, výklopné v rozsahu 180 stupňů. Pracovní úhel ráčnového mechanismu (úhel kroku zpětného chodu) je menší než 5 stupňů. Klíč je nejlepší utahovací řešení a dokonalejši společník pro profesionální řemeslníky.



USABILITY

With an innovative design of 74 teeth and its improved structure, it can be used in difficult conditions. Bi-hexagonal ring joint in range of 180 degrees. The working angle of the ratchet mechanism (reverse step angle) is smaller than 5 degrees. The wrench is the best tightening solution and the perfect companion for professional craftsmen.



VERWENDUNG

Dank dem innovativen Design mit 74 Zähnen und seiner verbesserten Struktur kann es auch unter schwierigen Bedingungen eingesetzt werden. 12-seitige Öse am Gelenkstift, um 180 Grad schwenkbar. Der Arbeitswinkel des Ratschenmechanismus (Rückschrittwinkel) beträgt weniger als 5 Grad. Der Schlüssel ist die ultimative Lösung zum Anziehen und der perfekte Begleiter für professionelle Handwerker.

Očkový klíč ráčnový, kloubový, ISO1711-1

Double flex-joint ratchet wrench, ISO1711-1

Knarren-Ring-Maulschlüssel mit Gelenk, ISO1711-1

kód/Code Bestellnummer	S (mm)	L (mm)	A1 (mm)	A2 (mm)	B1 (mm)	B2 (mm)	W (g)	 DPC/RRP (Kč/czsk)	DPC/RRP (EUR)	EAN13	
4CZ-278RK-10-12	10 x 12	187	10	10	21	25,4	170	25	874,38	36,43	8592667192294
4CZ-278RK-11-13	11 x 13	190	10	10	23,0	25,4	170	25	907,44	37,81	8592667192300
4CZ-278RK-12-14	12 x 14	207	10	10	25,4	27,4	210	25	938,84	39,12	8592667192317
4CZ-278RK-14-17	14 x 17	224	10	13,5	27,4	30,5	280	20	980,99	40,87	8592667192324
4CZ-278RK-17-19	17 x 19	245	13,5	13,5	30,5	34,2	360	15	1204,96	50,21	8592667192331

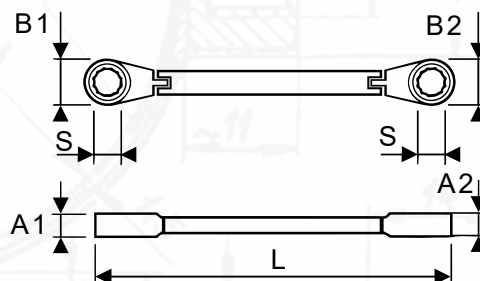
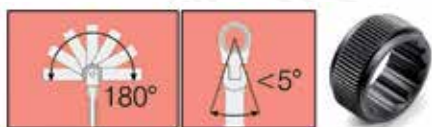



Kód / Code / Bestellnummer

4CZ-279

Industry line

CrV



POUŽITÍ

Klíč otočný 48 v 1 má ráčnový převod 72 zubů pro práci ve stísněných podmínkách. Osm velikostí otočných hlav klíče: 8 mm, 10 mm, 11 mm, 13 mm, 14 mm, 16 mm, 17 mm, 19 mm. Každá velikost může pracovat se 6 různými tvary hlav šroubů/matic (6HR, 12HR, 4HR, TRX, drážka, kulatý 6HR) = celkem 48 možností z jednoho nástroje.



USABILITY

The 48-in-1 universal key has a 72-tooth ratcheting gear for work in demanding conditions. Eight sizes of turning heads of the key: 8 mm, 10 mm, 11 mm, 13 mm, 14 mm, 16 mm, 17 mm, 19 mm. Each size can work with 6 different screw/nut head shapes (hexagonal, 12-point, square, TRX, round hexagonal) = in total 48 options from one tool.



VERWENDUNG

Der 48-in-1-Drehschlüssel verfügt über ein 72-Zahn-Ratschengetriebe für das Arbeiten in engen Räumen. Acht Größen von Drehschlüsselköpfen: 8 mm, 10 mm, 11 mm, 13 mm, 14 mm, 16 mm, 17 mm, 19 mm. Jede Größe kann mit 6 verschiedenen Schrauben-/Mutterkopfformen (6-kant, 12-kant, 4-kant, TRX, Schlitz, rund 6-kant) verwendet werden = 48 Gesamtoptionen mit einem Werkzeug.

Klíč otočný ráčnový
Bone ratchet wrench with swivel head
Knarrenschlüssel drehbar

kód/Code Bestellnummer	S1 (mm)	S2 (mm)	A1 (mm)	A2 (mm)	B1 (mm)	B2 (mm)	α°	L (mm)	W (g)	DPC/RRP (Kč/czsk)	DPC/RRP (EUR)	EAN13	
4CZ-279-8-19	14-16-17-19mm (9/16"-5/8"-11/16"-3/4")	8-10-11-13mm (5/16"-3/8"-7/16"-1/2")	55	44	37	31	15°	225	500	1	1010,74	42,11	8592667191921

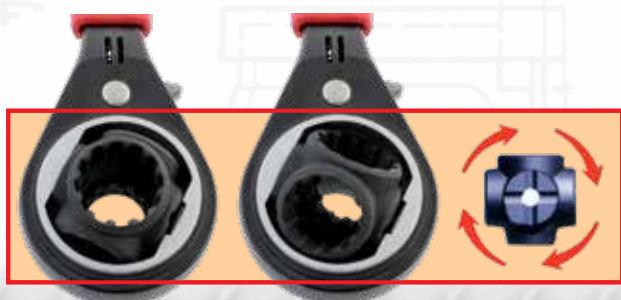
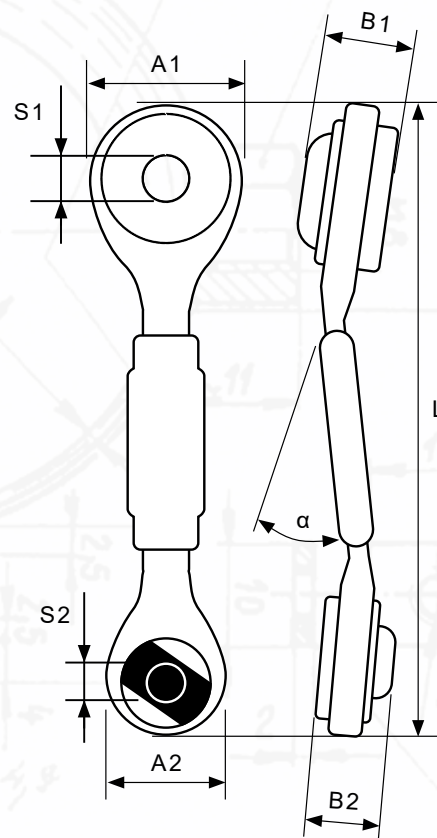



Kód / Code / Bestellnummer

4CZ-838

Industry
line

CrV

ISO 691
ISO 1711-1
ISO 3318
ISO 10104

DIN 838



POUŽITÍ

Klíč očkový vyhnutý DIN 838 vykováný z jednoho kusu kvalitní chromvanadiové oceli. Povrchová úprava: chromovaný leštěný povrch. Očka vyhnutá o 70° umožňují povolování/utahování zapuštěných šroubů/matic. 12ti hranná oka s profilem zajišťujícím maximální styčnou plochu přenosu síly na matice pro prodloužení životnosti klíče. V nabídce jsou i sady klíčů ve vinylovém obalu. Nabízíme kvalitu a design bez kompromisu.



USABILITY

Double offset ring wrench DIN 838 forged from one piece of high grade chrome-vanadium steel. Surface finish: chrome-plated polished surface. Rings at 70° offset enable to loose/tighten embedded screws/nuts. Bi-hexagonal rings with profile provide maximum contact and transfer power on nuts in order to extend lifetime of spanners. We also offer spanner sets in vinyl pouch packing. We offer quality and design without compromise.



VERWENDUNG

Ringschlüssel DIN 838 geschmiedet aus einem Chromvanadiumguss. Oberfläche: Poliertes Chrom. Ring geknickt um 70° ermöglicht Arbeit mit eingesetzten Muttern oder Schrauben. Profil des Ringes sichert maximale Kraftfläche auf die Mutter für Verlängerung der Lebensdauer des Schlüssels. Es gibt auch eine Reihe von Tasten in einem Kunststoffbeutel. Wir bieten Qualität und Design ohne Kompromisse.

Očkový klíč vyhnutý 70° DIN 838 chromovaný
Double offset ring wrench 70° DIN 838 chromium-plated
Ringschlüssel 70° DIN 838 verchromt

kód/Code Bestellnummer	S (mm)	L (mm)	A1 (mm)	A2 (mm)	B1 (mm)	B2 (mm)	C (mm)	W (g)		DPC/RRP (Kč/czsk)	DPC/RRP (EUR)	EAN13
4CZ-838-6X7	6 x 7	174	4,66	4,75	11,34	13,13	19,50	41	10	221,49	9,23	8592667108851
4CZ-838-8X9	8 x 9	187	5,70	5,70	14,07	16,07	20,50	64	10	221,49	9,23	8592667108875
4CZ-838-8X10	8 x 10	195	5,70	8,08	14,07	16,80	30,50	73	10	222,31	9,26	8592667108868
4CZ-838-10X11	10 x 11	211	8,00	8,50	16,80	18,06	30,50	83	10	227,27	9,47	8592667108615
4CZ-838-10X12	10 x 12	215	8,00	8,50	17,00	19,00	24,50	92	10	228,10	9,50	8592667108622
4CZ-838-12X13	12 x 13	218	8,00	8,50	19,74	21,21	24,50	116	10	227,27	9,47	8592667108639
4CZ-838-12X14	12 x 14	225	8,50	8,50	20,00	22,00	25,00	124	10	236,36	9,85	8592667108646
4CZ-838-13X17	13 x 17	230	8,70	8,70	21,00	23,00	25,50	133	10	236,36	9,85	8592667121324
4CZ-838-14X15	14 x 15	234	8,93	8,55	22,00	23,70	26,20	143	10	241,32	10,06	8592667108653
4CZ-838-14X17	14 x 17	245	9,50	9,20	23,00	25,00	27,00	161	10	247,93	10,33	8592667108660
4CZ-838-16X17	16 x 17	252	9,88	9,50	25,20	26,70	28,50	178	10	251,24	10,47	8592667108677
4CZ-838-16X18	16 x 18	263	10,50	10,30	27,00	28,00	29,50	202	10	264,46	11,02	8592667108684
4CZ-838-17X19	17 x 19	272	10,83	10,45	28,98	29,00	30,50	230	10	282,64	11,78	8592667108691
4CZ-838-18X19	18 x 19	272	10,83	10,45	28,98	30,14	30,50	222	10	307,44	12,81	8592667108707
4CZ-838-19X22	19 x 22	295	11,78	11,40	31,19	34,13	32,50	289	10	352,89	14,70	8592667108714
4CZ-838-20X22	20 x 22	295	11,78	11,40	31,19	34,13	32,50	290	10	351,24	14,63	8592667108721
4CZ-838-21X23	21 x 23	318	11,69	12,35	32,55	34,86	32,50	324	5	357,85	14,91	8592667108738
4CZ-838-22X24	22 x 24	318	11,69	12,35	32,55	34,86	32,50	316	5	357,85	14,91	8592667108745
4CZ-838-24X27	24 x 27	338	13,02	13,30	36,54	41,16	37,00	437	5	451,24	18,80	8592667108752
4CZ-838-25X28	25 x 28	357	13,49	13,30	38,43	42,53	35,00	504	5	451,24	18,80	8592667108769
4CZ-838-27X29	27 x 29	381	14,25	15,20	44,10	47,46	37,00	609	5	559,50	23,31	8592667108776
4CZ-838-27X30	27 x 30	381	14,25	15,20	44,10	47,46	37,00	609	3	572,73	23,86	8592667108783
4CZ-838-30X32	30 x 32	381	14,25	15,20	44,10	47,46	37,00	584	3	579,34	24,14	8592667108790
4CZ-838-32X36	32 x 36	400	15,00	16,00	45,00	48,00	41,00	700	3	846,28	35,26	8592667108806
4CZ-838-36X41	36 x 41	430	16,00	17,00	47,00	50,00	41,00	900	2	1433,06	59,71	8592667108813
4CZ-838-41X46	41 x 46	470	17,00	18,00	48,00	51,00	41,00	1100	2	1977,69	82,40	8592667108820
4CZ-838-46X50	46 x 50	500	18,00	19,00	49,00	52,00	45,00	1400	1	2650,41	110,43	8592667108837
4CZ-838-50X55	50 x 55	550	19,00	20,00	50,00	53,00	45,00	1700	1	3638,84	151,62	8592667108844

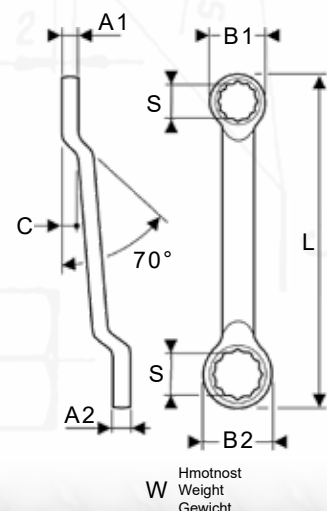
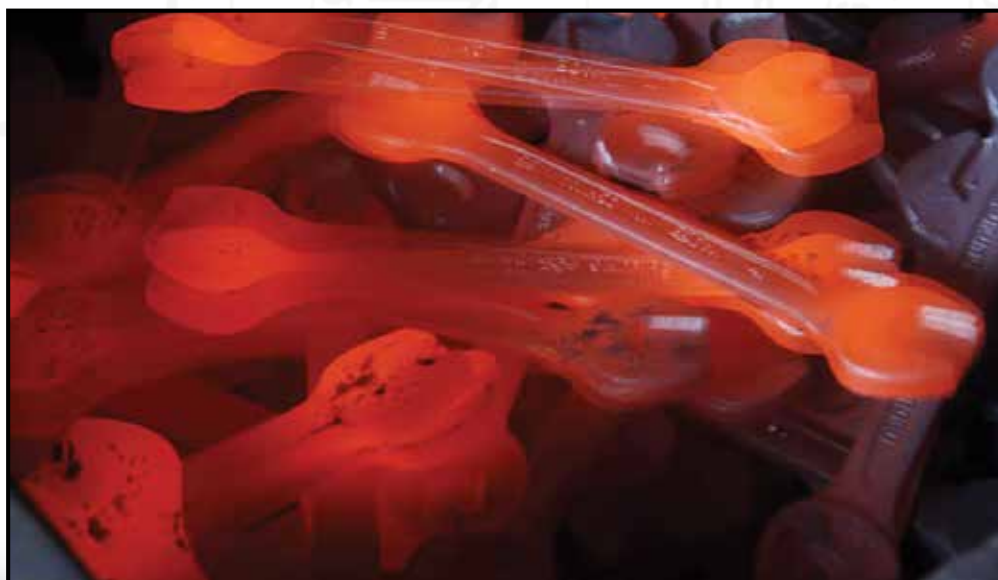
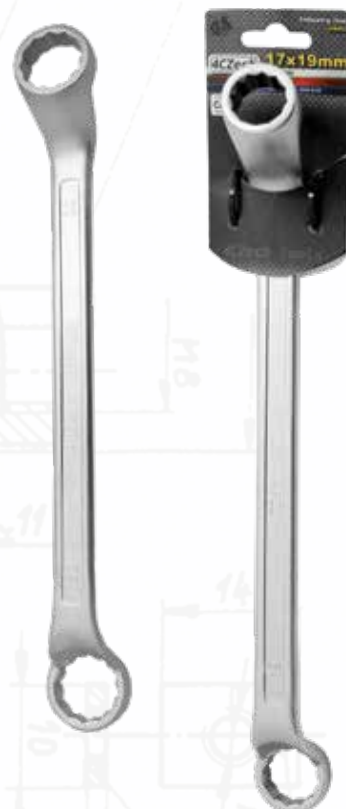



Sada klíčů 8-dílná DIN 838 ve vinylovém pouzdře (6x7 - 30x32mm)
8 pcs wrench set DIN 838 in a vinyl pouch (6x7 - 30x32mm)
8-teiliger Schlüsselsatz DIN 838 in Vinyelhülle (6x7 - 30x32mm)

kód/Code Bestellnummer	typ/type	obsah/content Inhalt	W (g)	1	DPC/RRP (Kč/czk)	DPC/RRP (EUR)	EAN13
4CZ-838-508	DIN 838	6 - 32 mm	1900	1	2688,43	112,02	8592667109421

Klíče jsou baleny v praktickém vinylovém obalu opatřeném očky na zavěšení.
Wrenches are packed in a practical vinyl pouch provided with eyelets (opening) for hanging.
Die Schlüssel werden in einem handlichen Gehäuse Vinyl mit Ösen zum Aufhängen versehen verpackt.

obsah / content / Inhalt	velikost / size / Größe
Očkový klíč vyhnutý 70° DIN 838 chromovaný / Double offset ring wrench 70° DIN 838 chromium-plated Ringschlüssel 70° DIN 838 verchromt	6 x 7 ; 8 x 9 ; 10 x 11 ; 12 x 13 ; 16 x 17 18 x 19 ; 24 x 27 ; 30 x 32 mm

Sada klíčů 12-dílná DIN 838 ve vinylovém pouzdře (6x7 - 30x32mm)
12 pcs wrench set DIN 838 in a vinyl pouch (6x7 - 30x32mm)
12-teiliger Schlüsselsatz DIN 838 im Vinyelhülle (6x7 - 30x32mm)

kód/Code Bestellnummer	typ/type	obsah/content Inhalt	W (g)	1	DPC/RRP (Kč/czk)	DPC/RRP (EUR)	EAN13
4CZ-838-512	DIN 838	6 - 32 mm	3300	1	4323,97	180,17	8592667109438



obsah / content / Inhalt	velikost / size / Größe
Očkový klíč vyhnutý 70° DIN 838 chromovaný / Double offset ring wrench 70° DIN 838 chromium-plated Ringschlüssel 70° DIN 838 verchromt	6 x 7 ; 8 x 9 ; 10 x 11 ; 12 x 13 ; 14 x 15 ; 16 x 17 ; 18 x 19 ; 20 x 22 ; 21 x 23 ; 24 x 27 ; 25 x 28 ; 30 x 32 mm



Kód / Code / Bestellnummer

4CZ-653

Standard
line

CrV

ISO 2236
ISO 1085

DIN
896



POUŽITÍ



USABILITY



VERWENDUNG

Z tenkostěnně zušlechtněné ocelové trubky, s příčným otvorem pro roubík.

Made from thin-walled heat-treatable steel tube, with cross-hole for tommy bar.

Aus dünnwandigem Vergütungsstahlrohr, mit Querbohrung für Drehstift.

DIN 896 B
ISO 2236
ISO 1085

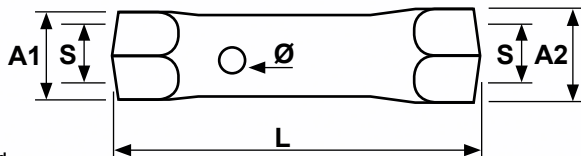

Trubkový klíč oboustranný
Tubular box spanner double-sided
Rohrsteckschlüssel zweiseitig

kód/Code	S	L	A1	A2	Ø	W		DPC/RRP (Kč/czk)	DPC/RRP (EUR)	EAN13
4CZ-653-6X7	6 x 7	110	10,5	11,3	6,0	40	15	99,17	4,13	8592667152557
4CZ-653-8X10	8 x 10	123	12,7	13,6	6,3	70	15	127,27	5,30	8592667152564
4CZ-653-8X9	8 x 9	110	12,5	13,8	6,4	40	15	109,92	4,58	8592667152571
4CZ-653-10X11	10 x 11	123	15,6	16,5	6,3	70	10	137,19	5,72	8592667152298
4CZ-653-10X13	10 x 13	140	15,7	18,7	8,6	90	10	161,98	6,75	8592667152304
4CZ-653-12X13	12 x 13	140	17,8	19,2	8,7	90	10	166,12	6,92	8592667152311
4CZ-653-13X17	13 x 17	150	19,1	23,8	10,4	110	10	197,52	8,23	8592667152328
4CZ-653-14X15	14 x 15	140	20,3	21,2	8,6	110	10	197,52	8,23	8592667152335
4CZ-653-14X17	14 x 17	150	20,3	23,6	10,4	110	10	198,35	8,26	8592667152342
4CZ-653-16X17	16 x 17	150	22,5	23,6	11,9	110	10	202,48	8,44	8592667152359
4CZ-653-17X19	17 x 19	160	25,1	27,1	12,4	190	10	228,10	9,50	8592667152366
4CZ-653-18X19	18 x 19	160	26,3	26,9	11,9	200	10	228,10	9,50	8592667152373
4CZ-653-18X21	18 x 21	162	26,1	29,1	12,4	220	5	276,03	11,50	8592667152380
4CZ-653-19X22	19 x 22	170	27,7	30,5	12,5	230	5	276,03	11,50	8592667152397
4CZ-653-20X22	20 x 22	170	28,1	30,5	12,7	240	5	263,64	10,98	8592667152403
4CZ-653-21X23	21 x 23	170	29,7	31,8	14,0	240	5	288,43	12,02	8592667152410
4CZ-653-21X24	21 x 24	170	30,7	33,0	14,4	300	5	289,26	12,05	8592667152427
4CZ-653-22X24	22 x 24	190	31,4	33,5	14,4	350	5	289,26	12,05	8592667152434
4CZ-653-24X27	24 x 27	190	33,6	33,7	14,4	380	5	352,89	14,70	8592667152441
4CZ-653-25X28	25 x 28	200	35,0	38,6	16,3	400	5	390,08	16,25	8592667152458
4CZ-653-27X32	27 x 32	200	37,2	42,9	16,3	420	5	517,36	21,56	8592667152465
4CZ-653-30X32	30 x 32	204	39,8	42,7	16,6	430	5	514,05	21,42	8592667152472
4CZ-653-30X34	30 x 34	203	41,0	45,8	16,1	510	4	571,07	23,79	8592667152489
4CZ-653-32X36	32 x 36	220	43,0	47,9	18,2	550	4	571,07	23,79	8592667152496
4CZ-653-36X41	36 x 41	220	48,9	53,8	18,2	660	4	606,61	25,28	8592667152502
4CZ-653-41X46	41 x 46	245	53,8	59,9	20,2	800	2	965,29	40,22	8592667152519
4CZ-653-46X50	46 x 50	245	60,5	65,5	19,8	1030	2	1147,11	47,80	8592667152526
4CZ-653-50X55	50 x 55	245	65,9	71,1	19,8	1100	2	1206,61	50,28	8592667152533

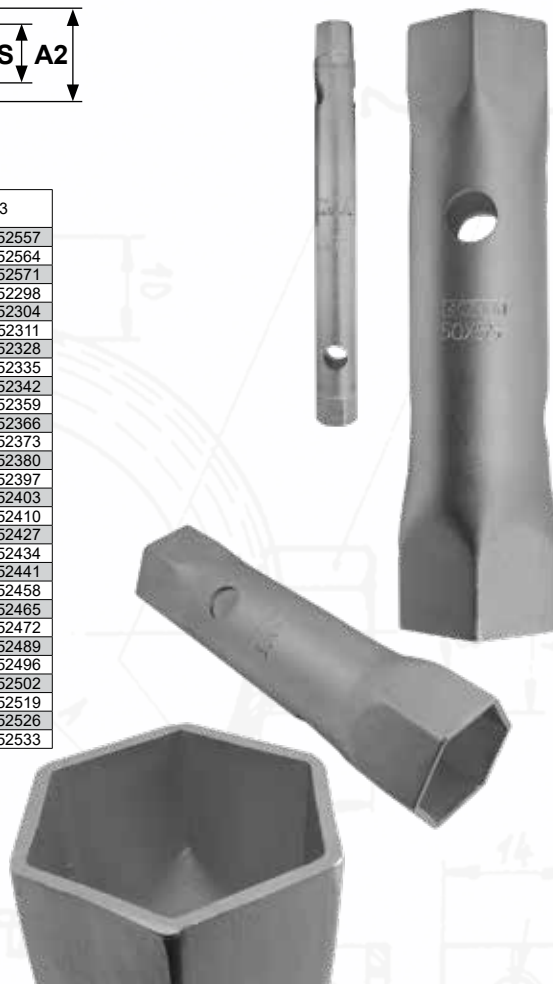

ISO 286-2

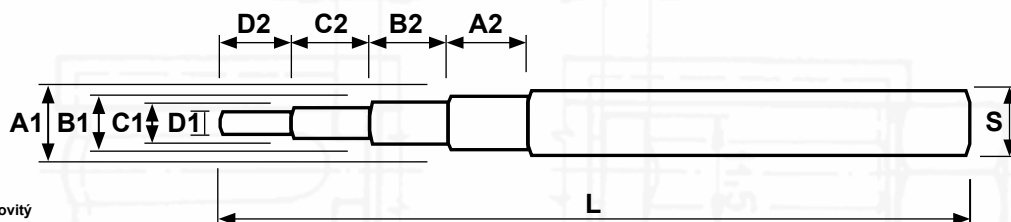

Roubík stupňovitý
Stepped tommy bar
Stufendrehstift

kód/Code	S	L	A1	A2	B1	B2	C1	C2	D1	D2	W		DPC/RRP (Kč/czk)	DPC/RRP (EUR)	EAN13
4CZ-653-R08	8	175	6	18	5,4	12	4,4	12	3,4	8	40	20	151,24	6,30	8592667152793
4CZ-653-R12	12	180	10	29	8	25	6	15	-	-	55	20	179,34	7,47	8592667152809
4CZ-653-R14	14	245	12	32	10	26	8	21	6	17	60	10	229,75	9,57	8592667152816



Kód / Code / Bestellnummer

4CZ-653HQ

Industry
line

CrV

ISO 2236
ISO 1085

DIN
896



POUŽITÍ

Kované: s masivní 6-hrannou stopkou pro klíče a příčným otvorem pro roubík. Velmi silné; s hlubokými vnitřními 6-hrany pro vyčnívající čepy. Chromvanadiová ocel, chromované.



USABILITY

Forged, with solid hexagon shaft for use with spanners and cross-hole for tommy bar. Very strong, with deep hexagon sockets for projecting threads. Chrome vanadium steel, chrome-plated.



VERWENDUNG

Geschmiedet; mit massivem 6-kant-Schaft für Schlüsselhilfe und Querbohrung für Drehstift. Sehr stark; mit tiefen Innensechskanten für überstehende Bolzen. Chrom-Vanadium-Stahl, verchromt.

DIN 896 A
ISO 2236
ISO 1085

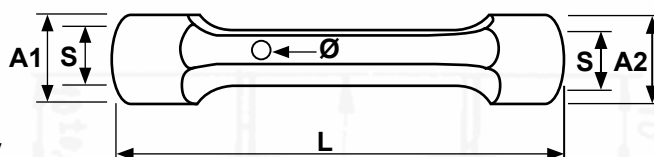

Trubkový klíč oboustranný HQ, kovaný
Tubular box spanner double-sided HQ, forged
Rohrsteckschlüssel zweiseitig HQ, geschmiedet

kód/Code Bestellnummer	S (mm)	L (mm)	A1 (mm)	A2 (mm)	Ø (mm)	W (g)		DPC/RRP (Kč/czk)	DPC/RRP (EUR)	EAN13
4CZ-653HQ-6X7	6 x 7	108	10,0	11,3	3,6	40	20	352,89	14,70	8592667152779
4CZ-653HQ-8X9	8 x 9	112	12,5	13,6	3,8	55	20	353,72	14,74	8592667152786
4CZ-653HQ-10X11	10 x 11	121	15,1	16,1	5,1	60	10	300,00	12,50	8592667152588
4CZ-653HQ-12X13	12 x 13	141	17,6	19,3	5,8	105	10	439,67	18,32	8592667152595
4CZ-653HQ-13X16	13 x 16	156	22,0	24,0	7,1	160	10	596,69	24,86	8592667152601
4CZ-653HQ-13X17	13 x 17	156	22,3	24,0	7,1	180	10	596,69	24,86	8592667152618
4CZ-653HQ-14X15	14 x 15	146	20,5	21,8	6,2	125	10	500,83	20,87	8592667152625
4CZ-653HQ-16X17	16 x 17	156	22,4	24,1	7,2	175	10	578,51	24,10	8592667152632
4CZ-653HQ-17X19	17 x 19	166	24,9	26,1	7,9	215	5	690,08	28,75	8592667152649
4CZ-653HQ-18X19	18 x 19	166	25,6	26,1	8,2	245	5	690,08	28,75	8592667152656
4CZ-653HQ-19X22	19 x 22	176	26,0	29,9	9,1	250	5	778,51	32,44	8592667152663
4CZ-653HQ-20X22	20 x 22	176	28,1	30,0	9,2	280	5	778,51	32,44	8592667152670
4CZ-653HQ-21X23	21 x 23	187	29,5	31,1	10,2	345	5	873,55	36,40	8592667152687
4CZ-653HQ-21X24	21 x 24	186	29,4	32,8	10,0	200	5	909,92	37,91	8592667152694
4CZ-653HQ-24X26	24 x 26	197	33,0	36,6	12,2	380	4	747,93	31,16	8592667152700
4CZ-653HQ-24X27	24 x 27	197	32,5	36,5	12,0	350	4	950,41	39,60	8592667152717
4CZ-653HQ-25X28	25 x 28	202	31,2	34,2	12,1	350	4	1078,51	44,94	8592667152724
4CZ-653HQ-30X32	30 x 32	213	41,6	44,5	14,1	680	4	1371,07	57,13	8592667152731
4CZ-653HQ-30X34	30 x 34	220	41,6	47,0	14,1	700	3	1661,98	69,25	8592667152748
4CZ-653HQ-32X36	32 x 36	231	45,3	49,4	16,8	850	3	1824,79	76,03	8592667152755
4CZ-653HQ-34X36	34 x 36	240	46,5	49,4	16,8	900	3	2359,50	98,31	8592667152762





Kód / Code / Bestellnummer

4CZ-410

Industry
line

CrV

ISO
691

DIN
3118



POUŽITÍ

Klíče prstencové proříznuté na převlečné matice vhodné při práci na hydraulickém vedení, např. brzdovém systému automobilů k povolání či dotahování převlečných šroubů (holendry) na brzdovém potrubí, kdy je použití očkových klíčů nemožné, nebo je lze použít i u odvzdušňovacích šroubů na brzdových třmenech. Očková ústí vykloněná o 15° od osy těla klíče. 6hranné očko pro snížení rizika deformace matice z měkkých materiálů, vykloněné o 15° od osy těla klíče. Vykované z chrom-vanadové oceli. Chromovaný leštěný povrch.



USABILITY

Ring-shaped wrenches cut to flare nuts suitable for work in hydraulic pipes, f.ex. in brake system of vehicles, they can be used for loosening and tightening flare screws (holenders) on brake pipeline where the use of combination spanners is not possible or they can be used on breather screws of brake calipers. Wrench's head hinged of 15° from the wrench's body axis. 6 point head for reducing risk of deformation nuts made of soft metals. Made of chromium-vanadium steel. Satin chrome surface.



VERWENDUNG

Geschlitzte Ringschlüssel für Überwurfmutter, geeignet für die Arbeit an Hydraulikleitungen, z. B. an Fahrzeugbremsystemen, zum Lösen oder Nachziehen von Überwurfschrauben (Holländern) an der Bremsleitung, wo Ringschlüssel nicht verwendet werden können, oder auch für Entlüftungsschrauben von Bremsätteln. Ringöffnungen um 15° zur Achse des Schlüsselkörpers abgewinkelt. 6-Kant-Öffnungen für eine Reduzierung der Deformierungsgefahr bei Weichmetallmutter. Geschmiedet aus Chrom-Vanadium-Stahl. Verchromte polierte Oberfläche.

Klíč na převlečné matice
Flare nut wrench
Offener Doppelringschlüssel

kód/Code Bestellnummer	S (mm)	L (mm)	A1 (mm)	A2 (mm)	B1 (mm)	B2 (mm)	W (g)		DPC/RRP (Kč/czk)	DPC/RRP (EUR)	EAN13
4CZ-410-6X8	6 x 8	125	7,8	8,8	16,6	18,5	50	12	154,55	6,44	8592667146013
4CZ-410-8X10	8 x 10	127	8,5	8,5	11,3	19,1	50	12	164,46	6,85	8592667146020
4CZ-410-9X11	9 x 11	140	8,5	9,9	21,9	29,2	65	12	188,43	7,85	8592667146037
4CZ-410-10X12	10 x 12	140	9,6	9,9	22,1	24,2	65	12	190,08	7,92	8592667145900
4CZ-410-11X13	11 x 13	140	9,7	9,8	21,9	24,5	65	12	190,91	7,95	8592667145917
4CZ-410-12X14	12 x 14	165	10,3	10,6	25,8	27,4	95	12	205,79	8,57	8592667145924
4CZ-410-13X14	13 x 14	165	10,2	10,6	25,8	27,5	95	12	227,27	9,47	8592667145931
4CZ-410-15X17	15 x 17	173	10,9	11,2	28,2	29,8	110	12	234,71	9,78	8592667145948
4CZ-410-16X17	16 x 17	170	10,5	11,5	28,2	29,8	110	12	234,71	9,78	8592667145955
4CZ-410-17X19	17 x 19	179	11,4	11,9	29,7	31,5	125	6	246,28	10,26	8592667145962
4CZ-410-18X19	18 x 19	179	11,4	11,5	29,4	31,7	125	6	248,76	10,37	8592667145979
4CZ-410-19X22	19 x 22	198	12,5	12,5	31,4	35,9	160	6	294,21	12,26	8592667145986
4CZ-410-21X23	21 x 23	210	13,7	13,9	36,1	39,0	210	6	406,61	16,94	8592667145993
4CZ-410-22X24	22 x 24	213	13,7	14,2	36,3	39,2	215	6	406,61	16,94	8592667146006

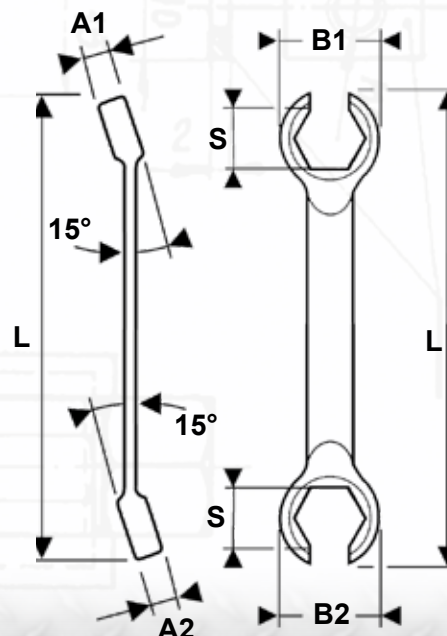



Kód / Code / Bestellnummer

4CZ-410R

Industry
line

CrV

ISO
691

DIN
3118



POUŽITÍ

Klíče prstencové proříznuté ráčnové na převlečné matice. Vhodné pro práci na hydraulickém vedení, např. brzdovém systému automobilu k povolání či dotažení převlečných matic na brzdovém potrubí, nebo je lze použít i u odvětrávacích šroubů na brzdových třmenech, kdy je použití očkových klíčů nemožné. Vykované z chrom-vanadové oceli. Chromovaný leštěný povrch. Ráčna má 72 zubů. 12hranný profil otevřené očkové hlavy. Protiskluzová rukojeť.



USABILITY

Flare nut wrenches with a ratchet. Suitable for working on hydraulic lines, e.g. the brake system of a car to loosen or tighten the flare nuts on the brake pipe, or they can also be used for breather bolts on brake calipers, when the use of combination spanners is impossible. Forged from chrome-vanadium steel, polished surface. The ratchet has 72 teeth. 12-sided open eyelet head profile. Anti-slip handle.



VERWENDUNG

Geschlitzte Knarren-Ringschlüssel für Überwurfmutter. Geeignet für die Arbeit an Hydraulikleitungen, z.B. Fahrzeugbremsystemen, zum Lösen oder Nachziehen von Überwurfmutter an der Bremsleitung, oder auch für Entlüftungsschrauben an Bremsätteln, wenn der Einsatz von Ringschlüsseln nicht möglich ist. Aus Chrom-Vanadium-Stahl geschmiedet. Chrompolierte Oberfläche. Die Knarre hat 72 Zähne. 12-kantiges Profil des offenen Ringes. Rutschfester Griff.

Klíč na převlečné matice ráčnový
Flare nut wrench ratchet
Knarren-Offener Doppelringschlüssel

kód/Code Bestellnummer	S (mm)	L (mm)	A (mm)	B (mm)	W (g)	 DPC/RRP (Kč/cz)	DPC/RRP (EUR)	EAN13	
4CZ-410R-8	8	141	16	23,7	60	25	472,73	19,70	8592667191846
4CZ-410R-9	9	152	16,8	28,6	90	25	472,73	19,70	8592667191853
4CZ-410R-10	10	152	16,8	28,6	90	25	472,73	19,70	8592667191860
4CZ-410R-11	11	156	16,8	30,4	90	25	492,56	20,52	8592667191877
4CZ-410R-12	12	171	17,8	33,7	115	25	492,56	20,52	8592667191884
4CZ-410R-13	13	171	17,8	33,7	110	25	505,79	21,07	8592667191891
4CZ-410R-14	14	187	17,8	38	140	25	505,79	21,07	8592667191907
4CZ-410R-15	15	187	17,8	38	150	25	505,79	21,07	8592667191914

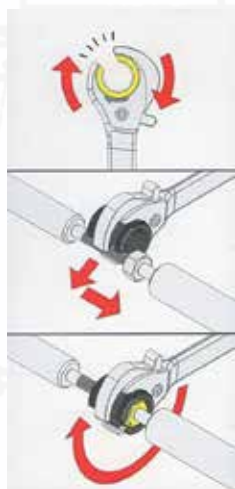
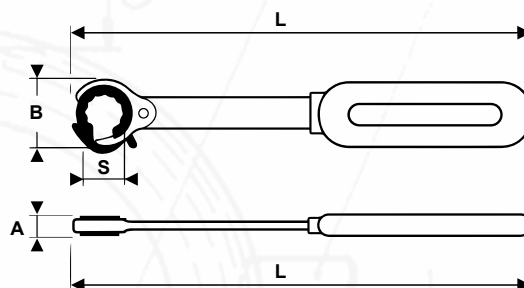



Kód / Code / Bestellnummer

4CZ-710

Industry
line

NF-E
74 331
ISO 2936

DIN 911



POUŽITÍ

Zástrčné šestihranné klíče vyrobené z chrom-vanadové oceli pro vyšší odolnost vůči namáhání než vyžaduje norma. Obvod pravocíh plochy má zkosenou hranu pro snazší zavedení do hlavy šroubu. Kulová hlava umožňuje rychlou a snadnou práci nakloněným klíčem pod úhlem až 15° v místech s omezeným přístupem. Značná mechanická odolnost, odolné proti korozi. V kompaktním a odolném držáku z elastomeru. Použitý elastomer je odolný vůči opotřebení, teplotním výkyvům a běžně užívaným chemikáliím. Snadné a rychlé vyjímání klíčů z držáku. Okamžitý přístup ke všem velikostem.



USABILITY

Hex keys made of chromium-vanadium steel for higher resistance to strain than the norm requires. The working area has bevelled edge for better insertion into a screw's head. Ball-shaped head enables fast and easy work with a hinged wrench under the angle of 15° in places with limited access. Significant mechanical resistance, corrosion resistant. In compact and resistant elastomer hanger. The applied elastomer is wear-resistant, resistant to temperature fluctuations and common chemicals. Easy and fast pulling out from the hanger. Immediate access to all sizes



VERWENDUNG

Winkelschraubendreher gefertigt aus Chrom-Vanadium-Stahl für eine höhere Beständigkeit gegen Beanspruchung als es die Norm fordert. Die Arbeitsfläche hat außen eine gefaste Kante für ein einfacheres Einführen in den Schraubenkopf. Der Kugelkopf ermöglicht ein schnelles und einfaches Arbeiten mit geneigtem Schlüssel bis zu einem Winkel von 15° an Stellen mit eingeschränkter Zugänglichkeit. Enorme mechanische Festigkeit, Korrosionsbeständig. In einem kompakten und widerstandsfähigen Kunststoffhalter. Das verwendete Elastomer ist beständig gegen Verschleiß, Temperaturschwankungen und geläufig verwendete Chemikalien. Einfaches und schnelles Entnehmen der Schlüssel aus dem Halter. Sofortige Verfügbarkeit aller Größen

NF-E 74 331
ISO 2936
DIN 911



Zástrčný klíč šestihranný
Hexagon key L-wrench
6-kant-Winkelschraubendreher

kód/Code Bestellnummer	A (mm)	B (mm)	L (mm)	W (g)		DPC/RRP (Kč/czk)	DPC/RRP (EUR)	EAN13
4CZ-710-1,3	1,3	14	42	0,8	100	19,01	0,79	8592667160064
4CZ-710-1,5	1,5	16	47	1	100	17,36	0,72	8592667160071
4CZ-710-2	2	18	52	3	50	17,36	0,72	8592667160088
4CZ-710-2,5	2,5	21	59	3	50	17,36	0,72	8592667160095
4CZ-710-3	3	23	66	6	25	19,26	0,80	8592667160101
4CZ-710-3,5	3,5	26	70	8	20	24,05	1,00	8592667160118
4CZ-710-4	4	29	74	11	25	21,90	0,91	8592667160125
4CZ-710-4,5	4,5	31	80	13	20	25,95	1,08	8592667160132
4CZ-710-5	5	33	85	19	15	23,72	0,99	8592667160026
4CZ-710-5,5	5,5	33	85	22	10	30,00	1,25	8592667160033
4CZ-710-6	6	38	96	28	10	28,35	1,18	8592667160002
4CZ-710-7	7	41	102	42	10	36,45	1,52	8592667160019
4CZ-710-8	8	44	108	58	5	42,98	1,79	8592667159952
4CZ-710-9	9	47	114	81	5	57,85	2,41	8592667159969
4CZ-710-10	10	50	122	101	5	66,94	2,79	8592667159921
4CZ-710-11	11	53	129	129	3	100,83	4,20	8592667159938
4CZ-710-12	12	57	137	168	2	116,53	4,86	8592667159945
4CZ-710-13	13	63	145	207	2	146,28	6,10	8592667159914
4CZ-710-14	14	70	154	260	2	177,69	7,40	8592667159907
4CZ-710-17	17	80	177	444	2	287,60	11,98	8592667159891
4CZ-710-19	19	89	199	618	2	369,42	15,39	8592667159884

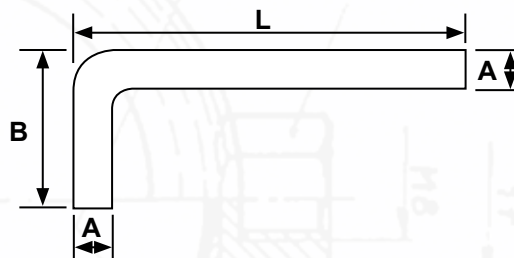



NF-E 74 331
ISO 2936
DIN 911



Zástrčný klíč šestihřanný s kuličkou
Hexagon key L-wrench with ball point
6-kant-Winkelschraubendreher mit Kugelkopf

kód/Code Bestellnummer	A (mm)	B (mm)	L (mm)	W (g)		DPC/RRP (Kč/czk)	DPC/RRP (EUR)	EAN13
4CZ-710K-1,5	1,5	16	47	1	100	31,98	1,33	8592667163331
4CZ-710K-2	2	18	52	3	50	31,98	1,33	8592667163416
4CZ-710K-2,5	2,5	21	59	3	50	31,98	1,33	8592667163423
4CZ-710K-3	3	23	66	6	25	35,04	1,46	8592667163430
4CZ-710K-3,5	3,5	26	70	8	20	45,45	1,89	8592667163447
4CZ-710K-4	4	29	74	11	25	37,85	1,58	8592667163454
4CZ-710K-4,5	4,5	31	80	13	20	47,11	1,96	8592667163461
4CZ-710K-5	5	33	85	19	15	47,93	2,00	8592667163478
4CZ-710K-5,5	5,5	33	85	22	10	57,02	2,38	8592667163485
4CZ-710K-6	6	38	96	28	10	57,02	2,38	8592667163492
4CZ-710K-7	7	41	102	42	10	73,55	3,06	8592667163508
4CZ-710K-8	8	44	108	58	5	95,04	3,96	8592667163515
4CZ-710K-9	9	47	114	81	5	108,26	4,51	8592667163522
4CZ-710K-10	10	50	122	101	5	148,76	6,20	8592667163348
4CZ-710K-11	11	53	129	129	3	161,98	6,75	8592667163355
4CZ-710K-12	12	57	137	168	2	186,78	7,78	8592667163362
4CZ-710K-13	13	63	145	207	2	235,54	9,81	8592667163379
4CZ-710K-14	14	70	154	260	2	284,30	11,85	8592667163386
4CZ-710K-17	17	80	177	444	2	461,16	19,21	8592667163393
4CZ-710K-19	19	89	199	618	2	589,26	24,55	8592667163409

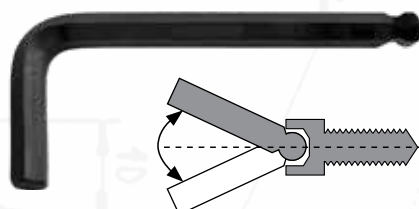
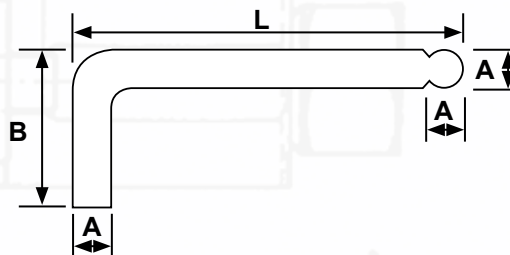

NF-E 74 331
ISO 2936
DIN 911



Zástrčný klíč šestihřanný s kuličkou prodloužený
Hexagon key L-wrench with ball point, long
6-kant-Winkelschraubendreher mit Kugelkopf, verchromt

kód/Code Bestellnummer	A (mm)	B (mm)	L (mm)	W (g)		DPC/RRP (Kč/czk)	DPC/RRP (EUR)	EAN13
4CZ-710PK-1,5	1,5	16	64	1	100	31,98	1,33	8592667163713
4CZ-710PK-2	2	18	77	2	50	30,99	1,29	8592667163775
4CZ-710PK-2,5	2,5	21	88	4	50	30,99	1,29	8592667163782
4CZ-710PK-3	3	23	93	7	25	35,62	1,48	8592667163799
4CZ-710PK-4	4	29	104	13	25	39,26	1,64	8592667163805
4CZ-710PK-4,5	4,5	32	114	15	20	47,93	2,00	8592667163812
4CZ-710PK-5	5	33	120	23	15	47,11	1,96	8592667163829
4CZ-710PK-5,5	5,5	36	130	27	10	57,02	2,38	8592667163836
4CZ-710PK-6	6	38	141	40	10	57,02	2,38	8592667163843
4CZ-710PK-7	7	40	146	55	10	77,69	3,24	8592667163850
4CZ-710PK-8	8	44	158	78	5	91,74	3,82	8592667163867
4CZ-710PK-9	9	47	168	109	5	111,57	4,65	8592667163874
4CZ-710PK-10	10	50	180	140	5	142,15	5,92	8592667163720
4CZ-710PK-11	11	53	191	180	3	178,51	7,44	8592667163737
4CZ-710PK-12	12	57	202	220	2	184,30	7,68	8592667163744
4CZ-710PK-14	14	70	229	360	2	281,82	11,74	8592667163751
4CZ-710PK-17	17	80	262	570	2	438,02	18,25	8592667163768

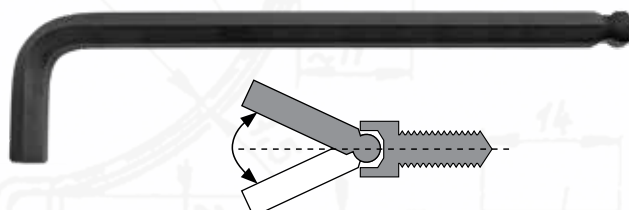
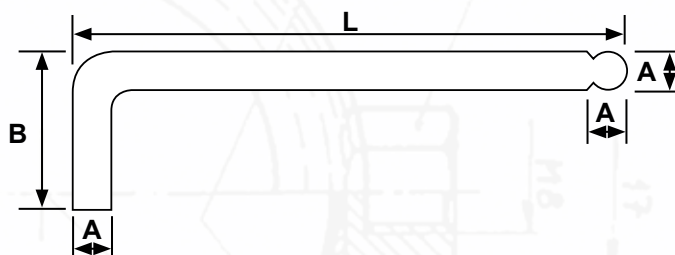



NF-E 74 331
ISO 2936
DIN 911



Sada zástrčných klíčů šestihranných 9-dílná na plastovém držáku
9 pcs of hexagon key L-wrenches set on plastic holder
6-kant-Winkelschraubendreher Satz 9 Stück auf Plastikhalter

kód/Code Bestellnummer	obsah/content Inhalt	W (g)		DPC/RRP (Kč/czk)	DPC/RRP (EUR)	EAN13
4CZ-710-S9	1,5/2/2,5/3/4/5/6/8/10	250	10	405,79	16,91	8592667159990



NF-E 74 331
ISO 2936
DIN 911

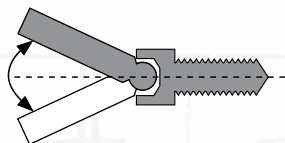

Sada zástrčných klíčů šestihranných s kuličkou 9-dílná na plastovém držáku
9 pcs of hexagon key L-wrenches with ball point set on plastic holder
6-kant-Winkelschraubendreher mit Kugelkopf Satz 9 Stück auf Plastikhalter

kód/Code Bestellnummer	obsah/content Inhalt	W (g)		DPC/RRP (Kč/czk)	DPC/RRP (EUR)	EAN13
4CZ-710K-S9	1,5/2/2,5/3/4/5/6/8/10	250	10	473,55	19,73	8592667163539



NF-E 74 331
ISO 2936
DIN 911



Sada zástrčných klíčů šestihranných prodloužených 9-dílná na plastovém držáku
9 pcs of long hexagon key L-wrenches set on plastic holder
6-kant-Winkelschraubendreher, verchromt Satz 9 Stück auf Plastikhalter

kód/Code Bestellnummer	obsah/content Inhalt	W (g)		DPC/RRP (Kč/czk)	DPC/RRP (EUR)	EAN13
4CZ-710P-S9	1,5/2/2,5/3/4/5/6/8/10	320	10	479,34	19,97	8592667159976



NF-E 74 331
ISO 2936
DIN 911

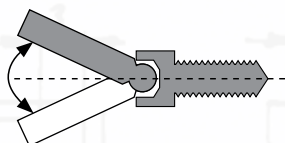

Sada zástrčných klíčů šestihranných s kuličkou prodloužených 9-dílná na plastovém držáku
9 pcs of long hexagon key L-wrenches with ball point set on plastic holder
6-kant-Winkelschraubendreher mit Kugelkopf, verchromt Satz 9 Stück auf Plastikhalter

kód/Code Bestellnummer	obsah/content Inhalt	W (g)		DPC/RRP (Kč/czk)	DPC/RRP (EUR)	EAN13
4CZ-710PK-S9	1,5/2/2,5/3/4/5/6/8/10	320	10	557,85	23,24	8592667159983





Kód / Code / Bestellnummer

4CZ-80

Industry
line

CrV



POUŽITÍ

Robustní a přesné bity pro řemeslnou výrobu i průmysl na šroubové spoje všeho druhu. Kvalitní chrom-vanadová ocel, průběžně tvrzená. Dobrá odolnost proti opotřebení zajišťuje dlouhou životnost. 1/4" šestihránná stopka je vhodná pro většinu standardních držáků na šroubovácích se sklíčováním na bity, elektrických šroubovácích a akumulátorových šroubovácích. V nabídce i bity pro montáže sádkartonu.

Vykováno pro použití v nejtěžších aplikacích



USABILITY

Robust and precise bits for craft production and industry for screw joints of all kinds. Quality chrome-vanadium steel, continuously hardened. Good wear resistance ensures a long service life. The 1/4" hex shank fits most standard chuck screwdriver holders, electric screwdrivers and cordless screwdrivers. Drywall bits are also available.

Forged for use in the toughest applications



VERWENDUNG

Robuste und präzise Bits für Handwerk und Industrie für Verschraubungen aller Art. Qualitäts-Chrom-Vanadium-Stahl, durchgehend gehärtet. Gute Verschleißfestigkeit gewährleistet eine lange Lebensdauer. 1/4" Sechskantchaft ist geeignet für die meisten Standardhalter auf den Schraubendrehern mit Bit-Spannfuttern, Elektroschraubendreher und Akku-Schraubendreher. Das Angebot umfasst auch Bits für die Gipskartonmontage.

Geschmiedet für den Einsatz in den härtesten Anwendungen



Bit 1/4" PL, délka 25mm
Bits 1/4" PL, length 25mm
Bits 1/4" PL, Länge 25mm

kód/Code Bestellnummer	S	B (mm)	L (mm)	W (g)		DPC/RRP (Kč/czk)	DPC/RRP (EUR)	EAN13
4CZ-8071-20	SL2	0,4	25	12	2	27,69	1,15	8592667188792
4CZ-8071-21	SL2,5	0,4	25	13	2	27,69	1,15	8592667188815
4CZ-8071-30	SL3	0,5	25	14	2	27,69	1,15	8592667188839
4CZ-8071-40	SL4	0,5	25	15	2	27,69	1,15	8592667188853
4CZ-8071-45	SL4,5	0,6	25	16	2	27,69	1,15	8592667188877
4CZ-8071-55	SL5,5	0,8	25	16	2	27,69	1,15	8592667188891
4CZ-8071-60	SL6	1	25	16	2	27,69	1,15	8592667188914
4CZ-8071-65	SL6,5	1,2	25	16	2	27,69	1,15	8592667188938
4CZ-8071-81	SL8	1,6	25	17	2	44,63	1,86	8592667188952



Bit 1/4" PL, délka 25mm
Bits 1/4" PL, length 25mm
Bits 1/4" PL, Länge 25mm

Cena za balení
Price per package
Preis für Packung

kód/Code Bestellnummer	S	B (mm)	L (mm)	W (g)		DPC/RRP (Kč/czk)	DPC/RRP (EUR)	EAN13
4CZ-8071-20-50	SL2	0,4	25	214	50	223,97	9,33	8592667188808
4CZ-8071-21-50	SL2,5	0,4	25	218	50	223,97	9,33	8592667188822
4CZ-8071-30-50	SL3	0,5	25	230	50	223,97	9,33	8592667188846
4CZ-8071-40-50	SL4	0,5	25	235	50	223,97	9,33	8592667188860
4CZ-8071-45-50	SL4,5	0,6	25	250	50	223,97	9,33	8592667188884
4CZ-8071-55-50	SL5,5	0,8	25	270	50	223,97	9,33	8592667188907
4CZ-8071-60-50	SL6	1	25	275	50	223,97	9,33	8592667188921
4CZ-8071-65-50	SL6,5	1,2	25	287	50	223,97	9,33	8592667188945
4CZ-8071-81-50	SL8	1,6	25	343	50	785,12	32,71	8592667188969



Bit 1/4" PL, délka 50mm
Bits 1/4" PL, length 50mm
Bits 1/4" PL, Länge 50mm

kód/Code Bestellnummer	S	B (mm)	L (mm)	W (g)		DPC/RRP (Kč/czk)	DPC/RRP (EUR)	EAN13
4CZ-8081-20	SL2	0,4	50	20	2	37,11	1,55	8592667190092
4CZ-8081-21	SL2,5	0,4	50	21	2	37,11	1,55	8592667190115
4CZ-8081-30	SL3	0,5	50	23	2	37,11	1,55	8592667190139
4CZ-8081-40	SL4	0,5	50	23	2	37,11	1,55	8592667190153
4CZ-8081-45	SL4,5	0,6	50	24	2	37,11	1,55	8592667190177
4CZ-8081-55	SL5,5	0,8	50	26	2	37,11	1,55	8592667190191
4CZ-8081-60	SL6	1	50	28	2	37,11	1,55	8592667190214



Bit 1/4" PL, délka 50mm
Bits 1/4" PL
Bits 1/4" PL

Cena za balení
Price per package
Preis für Packung

kód/Code Bestellnummer	S	B (mm)	L (mm)	W (g)		DPC/RRP (Kč/czk)	DPC/RRP (EUR)	EAN13
4CZ-8081-20-50	SL2	0,4	50	384	50	500,00	20,83	8592667190108
4CZ-8081-21-50	SL2,5	0,4	50	405	50	500,00	20,83	8592667190122
4CZ-8081-30-50	SL3	0,5	50	410	50	500,00	20,83	8592667190146
4CZ-8081-40-50	SL4	0,5	50	475	50	500,00	20,83	8592667190160
4CZ-8081-45-50	SL4,5	0,6	50	475	50	500,00	20,83	8592667190184
4CZ-8081-55-50	SL5,5	0,8	50	525	50	500,00	20,83	8592667190207
4CZ-8081-60-50	SL6	1	50	590	50	500,00	20,83	8592667190221

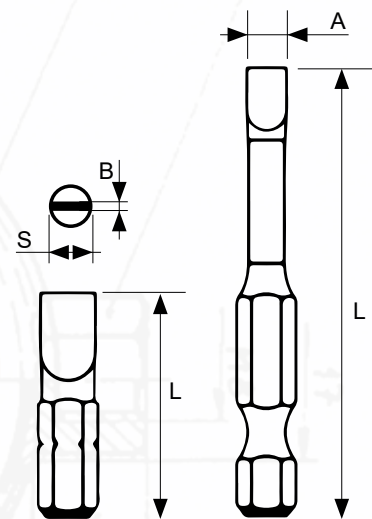



Bit 1/4" PH, délka 25mm
Bits 1/4" PH, length 25mm
Bits 1/4" PH, Länge 25mm

kód/Code Bestellnummer	S	L (mm)	W (g)		DPC/RRP (Kč/czk)	DPC/RRP (EUR)	EAN13
4CZ-8072-00	PH0	25	13	2	30,99	1,29	8592667188976
4CZ-8072-01	PH1	25	13	2	30,99	1,29	8592667188990
4CZ-8072-02	PH2	25	14	2	30,99	1,29	8592667189010
4CZ-8072-03	PH3	25	15	2	30,99	1,29	8592667189034
4CZ-8072-04	PH4	25	17	2	30,99	1,29	8592667189058

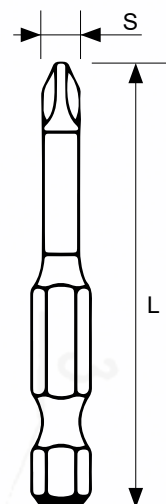
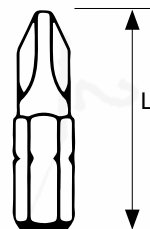

Bit 1/4" PH, délka 25mm
Bits 1/4" PH, length 25mm
Bits 1/4" PH, Länge 25mm

Cena za balení
Price per package
Preis für Packung

kód/Code Bestellnummer	S	L (mm)	W (g)		DPC/RRP (Kč/czk)	DPC/RRP (EUR)	EAN13
4CZ-8072-00-50	PH0	25	259	50	223,97	9,33	8592667188983
4CZ-8072-01-50	PH1	25	245	50	223,97	9,33	8592667189003
4CZ-8072-02-50	PH2	25	266	50	223,97	9,33	8592667189027
4CZ-8072-03-50	PH3	25	287	50	223,97	9,33	8592667189041
4CZ-8072-04-50	PH4	25	319	50	223,97	9,33	8592667189065



Bit 1/4" PH, délka 50mm
Bits 1/4" PH, length 50mm
Bits 1/4" PH, Länge 50mm

kód/Code Bestellnummer	S	L (mm)	W (g)		DPC/RRP (Kč/czk)	DPC/RRP (EUR)	EAN13
4CZ-8082-00	PH0	50	22	2	39,67	1,65	8592667190238
4CZ-8082-01	PH1	50	26	2	39,67	1,65	8592667190252
4CZ-8082-02	PH2	50	28	2	39,67	1,65	8592667190276
4CZ-8082-03	PH3	50	29	2	39,67	1,65	8592667190290



Bit 1/4" PH, délka 50mm
Bits 1/4" PH, length 50mm
Bits 1/4" PH, Länge 50mm

Cena za balení
Price per package
Preis für Packung

kód/Code Bestellnummer	S	L (mm)	W (g)		DPC/RRP (Kč/czk)	DPC/RRP (EUR)	EAN13
4CZ-8082-00-50	PH0	50	447	50	516,53	21,52	8592667190245
4CZ-8082-01-50	PH1	50	495	50	516,53	21,52	8592667190269
4CZ-8082-02-50	PH2	50	550	50	516,53	21,52	8592667190283
4CZ-8082-03-50	PH3	50	575	50	516,53	21,52	8592667190306





Bit 1/4" PZ, délka 25mm
Bits 1/4" PZ, length 25mm
Bits 1/4" PZ, Länge 25mm

kód/Code Bestellnummer	S	L (mm)	W (g)	DPC/RRP (Kč/czk)	DPC/RRP (EUR)	EAN13	
4CZ-8073-00	PZ0	25	14	2	30,99	1,29	8592667189072
4CZ-8073-01	PZ1	25	16	2	30,99	1,29	8592667189096
4CZ-8073-02	PZ2	25	15	2	30,99	1,29	8592667189119
4CZ-8073-03	PZ3	25	17	2	30,99	1,29	8592667189133
4CZ-8073-04	PZ4	25	18	2	30,99	1,29	8592667189157

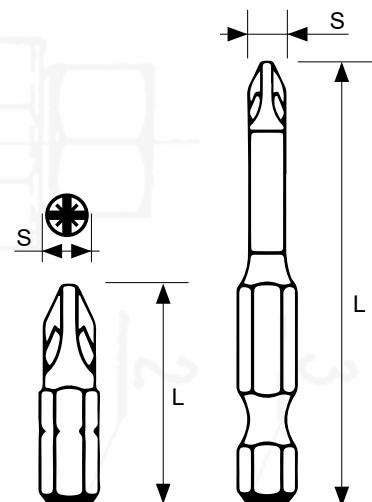

Bit 1/4" PZ, délka 25mm
Bits 1/4" PZ, length 25mm
Bits 1/4" PZ, Länge 25mm

Cena za balení
Price per package
Preis für Packung

kód/Code Bestellnummer	S	L (mm)	W (g)	DPC/RRP (Kč/czk)	DPC/RRP (EUR)	EAN13	
4CZ-8073-00-50	PZ0	25	246	50	223,97	9,33	8592667189089
4CZ-8073-01-50	PZ1	25	245	50	223,97	9,33	8592667189102
4CZ-8073-02-50	PZ2	25	265	50	223,97	9,33	8592667189126
4CZ-8073-03-50	PZ3	25	290	50	223,97	9,33	8592667189140
4CZ-8073-04-50	PZ4	25	325	50	223,97	9,33	8592667189164



Bit 1/4" PZ, délka 50mm
Bits 1/4" PZ, length 50mm
Bits 1/4" PZ, Länge 50mm

kód/Code Bestellnummer	S	L (mm)	W (g)	DPC/RRP (Kč/czk)	DPC/RRP (EUR)	EAN13	
4CZ-8083-00	PZ0	50	25	2	39,67	1,65	8592667190313
4CZ-8083-01	PZ1	50	26	2	39,67	1,65	8592667190337
4CZ-8083-02	PZ2	50	28	2	39,67	1,65	8592667190351
4CZ-8083-03	PZ3	50	30	2	39,67	1,65	8592667190375



Bit 1/4" PZ, délka 50mm
Bits 1/4" PZ, length 50mm
Bits 1/4" PZ, Länge 50mm

Cena za balení
Price per package
Preis für Packung

kód/Code Bestellnummer	S	L (mm)	W (g)	DPC/RRP (Kč/czk)	DPC/RRP (EUR)	EAN13	
4CZ-8083-00-50	PZ0	50	445	50	516,53	21,52	8592667190320
4CZ-8083-01-50	PZ1	50	489	50	516,53	21,52	8592667190344
4CZ-8083-02-50	PZ2	50	550	50	516,53	21,52	8592667190368
4CZ-8083-03-50	PZ3	50	575	50	516,53	21,52	8592667190382





Bit 1/4" TX, délka 25mm
Bits 1/4" TX, length 25mm
Bits 1/4" TX, Länge 25mm

kód/Code Bestellnummer	S	L (mm)	W (g)		DPC/RRP (Kč/czk)	DPC/RRP (EUR)	EAN13
4CZ-8074-04	T4	25	13	2	30,25	1,26	8592667189171
4CZ-8074-05	T5	25	14	2	30,25	1,26	8592667189195
4CZ-8074-06	T6	25	14	2	30,25	1,26	8592667189218
4CZ-8074-07	T7	25	14	2	27,69	1,15	8592667189232
4CZ-8074-08	T8	25	13	2	27,69	1,15	8592667189256
4CZ-8074-09	T9	25	13	2	27,69	1,15	8592667189270
4CZ-8074-10	T10	25	14	2	27,69	1,15	8592667189294
4CZ-8074-15	T15	25	15	2	27,69	1,15	8592667189317
4CZ-8074-20	T20	25	14	2	27,69	1,15	8592667189331
4CZ-8074-25	T25	25	15	2	27,69	1,15	8592667189355
4CZ-8074-27	T27	25	15	2	27,69	1,15	8592667189379
4CZ-8074-30	T30	25	17	2	27,69	1,15	8592667189393
4CZ-8074-35	T35	25	17	2	27,69	1,15	8592667189416
4CZ-8074-40	T40	25	17	2	27,69	1,15	8592667189430

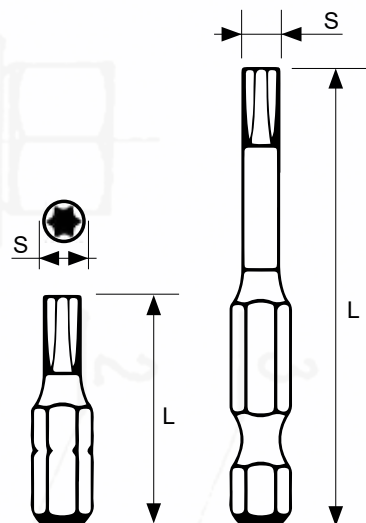

Bit 1/4" TX, délka 25mm
Bits 1/4" TX, length 25mm
Bits 1/4" TX, Länge 25mm

Cena za balení
Price per package
Preis für Packung

kód/Code Bestellnummer	S	L (mm)	W (g)		DPC/RRP (Kč/czk)	DPC/RRP (EUR)	EAN13
4CZ-8074-04-50	T4	25	220	50	241,32	10,06	8592667189188
4CZ-8074-05-50	T5	25	219	50	241,32	10,06	8592667189201
4CZ-8074-06-50	T6	25	230	50	241,32	10,06	8592667189225
4CZ-8074-07-50	T7	25	231	50	223,97	9,33	8592667189249
4CZ-8074-08-50	T8	25	254	50	223,97	9,33	8592667189263
4CZ-8074-09-50	T9	25	235	50	223,97	9,33	8592667189287
4CZ-8074-10-50	T10	25	236	50	223,97	9,33	8592667189300
4CZ-8074-15-50	T15	25	240	50	223,97	9,33	8592667189324
4CZ-8074-20-50	T20	25	258	50	223,97	9,33	8592667189348
4CZ-8074-25-50	T25	25	268	50	223,97	9,33	8592667189362
4CZ-8074-27-50	T27	25	282	50	223,97	9,33	8592667189386
4CZ-8074-30-50	T30	25	296	50	223,97	9,33	8592667189409
4CZ-8074-35-50	T35	25	318	50	223,97	9,33	8592667189423
4CZ-8074-40-50	T40	25	331	50	223,97	9,33	8592667189447



Bit 1/4" TX, délka 50mm
Bits 1/4" TX, length 50mm
Bits 1/4" TX, Länge 50mm

kód/Code Bestellnummer	S	L (mm)	W (g)		DPC/RRP (Kč/czk)	DPC/RRP (EUR)	EAN13
4CZ-8084-04	T4	50	23	2	38,84	1,62	8592667190399
4CZ-8084-05	T5	50	25	2	38,84	1,62	8592667190412
4CZ-8084-06	T6	50	25	2	38,84	1,62	8592667190436
4CZ-8084-07	T7	50	23	2	37,11	1,55	8592667190450
4CZ-8084-08	T8	50	24	2	37,11	1,55	8592667190474
4CZ-8084-09	T9	50	24	2	37,11	1,55	8592667190498
4CZ-8084-10	T10	50	24	2	37,11	1,55	8592667190511
4CZ-8084-15	T15	50	24	2	37,11	1,55	8592667190535
4CZ-8084-20	T20	50	26	2	37,11	1,55	8592667190559
4CZ-8084-25	T25	50	26	2	37,11	1,55	8592667190573
4CZ-8084-27	T27	50	27	2	37,11	1,55	8592667190597
4CZ-8084-30	T30	50	29	2	37,11	1,55	8592667190610
4CZ-8084-35	T35	50	30	2	37,11	1,55	8592667190634



Bit 1/4" TX, délka 50mm
Bits 1/4" TX, length 50mm
Bits 1/4" TX, Länge 50mm

Cena za balení
Price per package
Preis für Packung

kód/Code Bestellnummer	S	L (mm)	W (g)		DPC/RRP (Kč/czk)	DPC/RRP (EUR)	EAN13
4CZ-8084-04-50	T4	50	420	50	525,62	21,90	8592667190405
4CZ-8084-05-50	T5	50	424	50	525,62	21,90	8592667190429
4CZ-8084-06-50	T6	50	465	50	525,62	21,90	8592667190443
4CZ-8084-07-50	T7	50	427	50	500,00	20,83	8592667190467
4CZ-8084-08-50	T8	50	435	50	500,00	20,83	8592667190481
4CZ-8084-09-50	T9	50	437	50	500,00	20,83	8592667190504
4CZ-8084-10-50	T10	50	440	50	500,00	20,83	8592667190528
4CZ-8084-15-50	T15	50	450	50	500,00	20,83	8592667190542
4CZ-8084-20-50	T20	50	475	50	500,00	20,83	8592667190566
4CZ-8084-25-50	T25	50	506	50	500,00	20,83	8592667190580
4CZ-8084-27-50	T27	50	542	50	500,00	20,83	8592667190603
4CZ-8084-30-50	T30	50	575	50	500,00	20,83	8592667190627
4CZ-8084-35-50	T35	50	625	50	500,00	20,83	8592667190641





Bit 1/4" TT, délka 25mm
Bits 1/4" TT, length 25mm
Bits 1/4" TT, Länge 25mm

kód/Code Bestellnummer	S	L (mm)	W (g)		DPC/RRP (Kč/czk)	DPC/RRP (EUR)	EAN13
4CZ-8075-06	TT6	25	13	2	29,34	1,22	8592667189454
4CZ-8075-07	TT7	25	14	2	29,34	1,22	8592667189478
4CZ-8075-08	TT8	25	13	2	29,34	1,22	8592667189492
4CZ-8075-09	TT9	25	12	2	29,34	1,22	8592667189515
4CZ-8075-10	TT10	25	14	2	29,34	1,22	8592667189539
4CZ-8075-15	TT15	25	14	2	29,34	1,22	8592667189553
4CZ-8075-20	TT20	25	14	2	29,34	1,22	8592667189577
4CZ-8075-25	TT25	25	15	2	29,34	1,22	8592667189591
4CZ-8075-27	TT27	25	15	2	29,34	1,22	8592667189614
4CZ-8075-30	TT30	25	15	2	29,34	1,22	8592667189638
4CZ-8075-35	TT35	25	15	2	29,34	1,22	8592667189652
4CZ-8075-40	TT40	25	17	2	29,34	1,22	8592667189676

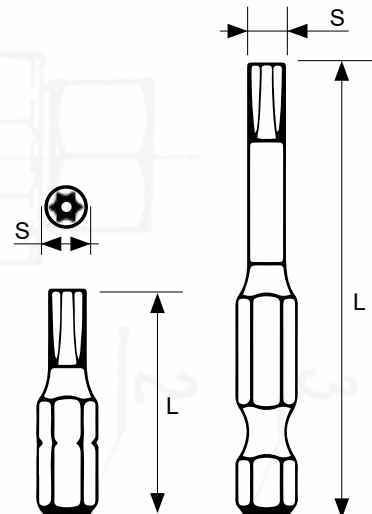

Bit 1/4" TT, délka 25mm
Bits 1/4" TT, length 25mm
Bits 1/4" TT, Länge 25mm

Cena za balení
Price per package
Preis für Packung

kód/Code Bestellnummer	S	L (mm)	W (g)		DPC/RRP (Kč/czk)	DPC/RRP (EUR)	EAN13
4CZ-8075-06-50	TT6	25	230	50	258,68	10,78	8592667189461
4CZ-8075-07-50	TT7	25	230	50	241,32	10,06	8592667189485
4CZ-8075-08-50	TT8	25	235	50	241,32	10,06	8592667189508
4CZ-8075-09-50	TT9	25	235	50	241,32	10,06	8592667189522
4CZ-8075-10-50	TT10	25	235	50	241,32	10,06	8592667189546
4CZ-8075-15-50	TT15	25	245	50	241,32	10,06	8592667189560
4CZ-8075-20-50	TT20	25	256	50	241,32	10,06	8592667189584
4CZ-8075-25-50	TT25	25	275	50	241,32	10,06	8592667189607
4CZ-8075-27-50	TT27	25	280	50	241,32	10,06	8592667189621
4CZ-8075-30-50	TT30	25	305	50	241,32	10,06	8592667189645
4CZ-8075-35-50	TT35	25	310	50	241,32	10,06	8592667189669
4CZ-8075-40-50	TT40	25	326	50	241,32	10,06	8592667189683



Bit 1/4" TT, délka 50mm
Bits 1/4" TT, length 50mm
Bits 1/4" TT, Länge 50mm

kód/Code Bestellnummer	S	L (mm)	W (g)		DPC/RRP (Kč/czk)	DPC/RRP (EUR)	EAN13
4CZ-8085-07	TT7	50	23	2	38,84	1,62	8592667190658
4CZ-8085-08	TT8	50	23	2	38,84	1,62	8592667190672
4CZ-8085-09	TT9	50	23	2	38,84	1,62	8592667190696
4CZ-8085-10	TT10	50	22	2	38,84	1,62	8592667190719
4CZ-8085-15	TT15	50	21	2	38,84	1,62	8592667190733
4CZ-8085-20	TT20	50	24	2	38,84	1,62	8592667190757
4CZ-8085-25	TT25	50	26	2	38,84	1,62	8592667190771
4CZ-8085-27	TT27	50	28	2	38,84	1,62	8592667190795
4CZ-8085-30	TT30	50	29	2	38,84	1,62	8592667190818
4CZ-8085-35	TT35	50	31	2	38,84	1,62	8592667190832



Bit 1/4" TT, délka 50mm
Bits 1/4" TT, length 50mm
Bits 1/4" TT, Länge 50mm

Cena za balení
Price per package
Preis für Packung

kód/Code Bestellnummer	S	L (mm)	W (g)		DPC/RRP (Kč/czk)	DPC/RRP (EUR)	EAN13
4CZ-8085-07-50	TT7	50	430	50	560,33	23,35	8592667190665
4CZ-8085-08-50	TT8	50	432	50	560,33	23,35	8592667190689
4CZ-8085-09-50	TT9	50	436	50	560,33	23,35	8592667190702
4CZ-8085-10-50	TT10	50	439	50	560,33	23,35	8592667190726
4CZ-8085-15-50	TT15	50	443	50	560,33	23,35	8592667190740
4CZ-8085-20-50	TT20	50	475	50	560,33	23,35	8592667190764
4CZ-8085-25-50	TT25	50	510	50	560,33	23,35	8592667190788
4CZ-8085-27-50	TT27	50	538	50	560,33	23,35	8592667190801
4CZ-8085-30-50	TT30	50	568	50	560,33	23,35	8592667190825
4CZ-8085-35-50	TT35	50	675	50	560,33	23,35	8592667190849





Bit 1/4" 6HR, délka 25mm
Bit 1/4" 6HR, length 25mm
Bit 1/4" 6-kant, Länge 25mm

kód/Code Bestellnummer	S (mm)	L (mm)	W (g)		DPC/RRP (Kč/czk)	DPC/RRP (EUR)	EAN13
4CZ-8076-15	H1,5	25	12	2	27,69	1,15	8592667189713
4CZ-8076-20	H2	25	14	2	27,69	1,15	8592667189737
4CZ-8076-25	H2,5	25	14	2	27,69	1,15	8592667189751
4CZ-8076-30	H3	25	14	2	27,69	1,15	8592667189775
4CZ-8076-40	H4	25	15	2	27,69	1,15	8592667189799
4CZ-8076-50	H5	25	16	2	27,69	1,15	8592667189812
4CZ-8076-55	H5,5	25	18	2	27,69	1,15	8592667189836
4CZ-8076-60	H6	25	19	2	27,69	1,15	8592667189850
4CZ-8076-65	H6,5	25	19	2	27,69	1,15	8592667189874
4CZ-8076-70	H7	25	22	2	44,63	1,86	8592667189898
4CZ-8076-80	H8	25	24	2	44,63	1,86	8592667189911

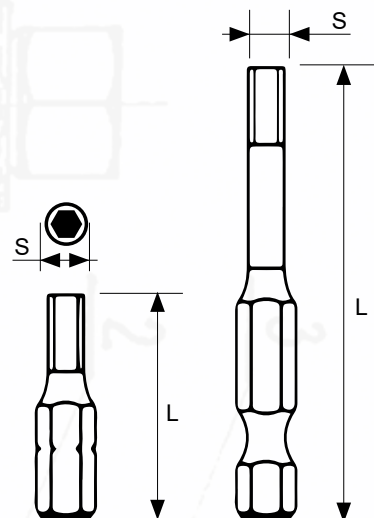

Bit 1/4" 6HR, délka 25mm
Bit 1/4" 6HR, length 25mm
Bit 1/4" 6-kant, Länge 25mm

Cena za balení
Price per package
Preis für Packung

kód/Code Bestellnummer	S (mm)	L (mm)	W (g)		DPC/RRP (Kč/czk)	DPC/RRP (EUR)	EAN13
4CZ-8076-15-50	H1,5	25	220	50	223,97	9,33	8592667189720
4CZ-8076-20-50	H2	25	230	50	223,97	9,33	8592667189744
4CZ-8076-25-50	H2,5	25	243	50	223,97	9,33	8592667189768
4CZ-8076-30-50	H3	25	245	50	223,97	9,33	8592667189782
4CZ-8076-40-50	H4	25	269	50	223,97	9,33	8592667189805
4CZ-8076-50-50	H5	25	305	50	223,97	9,33	8592667189829
4CZ-8076-55-50	H5,5	25	327	50	223,97	9,33	8592667189843
4CZ-8076-60-50	H6	25	345	50	223,97	9,33	8592667189867
4CZ-8076-65-50	H6,5	25	375	50	488,43	20,35	8592667189881
4CZ-8076-70-50	H7	25	395	50	499,17	20,80	8592667189904
4CZ-8076-80-50	H8	25	450	50	499,17	20,80	8592667189928



Bit 1/4" 6HR, délka 50mm
Bit 1/4" 6HR, length 50mm
Bit 1/4" 6-kant, Länge 50mm

kód/Code Bestellnummer	S (mm)	L (mm)	W (g)		DPC/RRP (Kč/czk)	DPC/RRP (EUR)	EAN13
4CZ-8086-20	H2	50	24	2	37,11	1,55	8592667190856
4CZ-8086-25	H2,5	50	24	2	37,11	1,55	8592667190870
4CZ-8086-30	H3	50	24	2	37,11	1,55	8592667190894
4CZ-8086-35	H3,5	50	24	2	37,11	1,55	8592667190917
4CZ-8086-40	H4	50	27	2	37,11	1,55	8592667190931
4CZ-8086-50	H5	50	29	2	37,11	1,55	8592667190955



Bit 1/4" 6HR, délka 50mm
Bit 1/4" 6HR, length 50mm
Bit 1/4" 6-kant, Länge 50mm

Cena za balení
Price per package
Preis für Packung

kód/Code Bestellnummer	S (mm)	L (mm)	W (g)		DPC/RRP (Kč/czk)	DPC/RRP (EUR)	EAN13
4CZ-8086-20-50	H2	50	460	50	500,00	20,83	8592667190863
4CZ-8086-25-50	H2,5	50	450	50	500,00	20,83	8592667190887
4CZ-8086-30-50	H3	50	440	50	500,00	20,83	8592667190900
4CZ-8086-35-50	H3,5	50	460	50	500,00	20,83	8592667190924
4CZ-8086-40-50	H4	50	505	50	500,00	20,83	8592667190948
4CZ-8086-50-50	H5	50	585	50	500,00	20,83	8592667190962





Bit 1/4" 6HR s kuličkou, délka 25mm
Bit 1/4" 6HR with ball, length 25mm
Bit 1/4" 6-kant mit Kugel, Länge 25mm

kód/Code Bestellnummer	S (mm)	L (mm)	W (g)		DPC/RRP (Kč/czk)	DPC/RRP (EUR)	EAN13
4CZ-8077-25	HB2,5	25	12	2	32,73	1,36	8592667189959
4CZ-8077-30	HB3	25	13	2	32,73	1,36	8592667189973
4CZ-8077-40	HB4	25	15	2	32,73	1,36	8592667189997
4CZ-8077-50	HB5	25	16	2	32,73	1,36	8592667190016
4CZ-8077-55	HB5,5	25	17	2	32,73	1,36	8592667190030
4CZ-8077-60	HB6	25	18	2	32,73	1,36	8592667190054

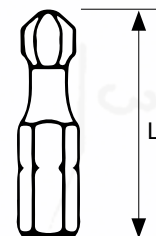

Bit 1/4" 6HR s kuličkou, délka 25mm
Bit 1/4" 6HR with ball, length 25mm
Bit 1/4" 6-kant mit Kugel, Länge 25mm

Cena za balení
Price per package
Preis für Packung

kód/Code Bestellnummer	S (mm)	L (mm)	W (g)		DPC/RRP (Kč/czk)	DPC/RRP (EUR)	EAN13
4CZ-8077-25-50	HB2,5	25	245	50	241,32	10,06	8592667189966
4CZ-8077-30-50	HB3	25	255	50	241,32	10,06	8592667189980
4CZ-8077-40-50	HB4	25	280	50	241,32	10,06	8592667190009
4CZ-8077-50-50	HB5	25	300	50	241,32	10,06	8592667190023
4CZ-8077-55-50	HB5,5	25	313	50	241,32	10,06	8592667190047
4CZ-8077-60-50	HB6	25	322	50	241,32	10,06	8592667190061



Bit 1/4" PH2 pro sádrokarton 25mm s dorazem
Bit 1/4" PH2 for drywall 25mm with stop
Bit 1/4" PH2 für Gipskarton 25 mm mit Anschlag

kód/Code Bestellnummer	S	D (mm)	L (mm)	I (mm)	W (g)		DPC/RRP (Kč/czk)	DPC/RRP (EUR)	EAN13
4CZ-5911-111	PH2	14	25	12	32	2	26,86	1,12	8592667180901
4CZ-5911-112	PH2	14	50	36	48	2	50,41	2,10	8592667180789
4CZ-5911-121	PZ2	14	25	12	33	2	30,25	1,26	8592667188778
4CZ-5911-122	PZ2	14	50	36	50	2	61,16	2,55	8592667188785

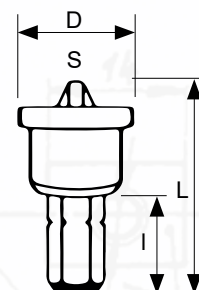

Držák bitů a vrutů magnetický nastavitelný pro sádrokarton 1/4" s magnetickým držákem pro bity + bit PZ2
Adjustable magnetic bit and screw holder for drywall 1/4" with magnetic holder for bits + bit PZ2
Bit- und Schraubenhalter magnetisch verstellbar für Gipskarton 1/4" mit magnetischem Halter für Bits + Bit PZ2

kód/Code Bestellnummer	S	D (mm)	L (mm)	I (mm)	W (g)		DPC/RRP (Kč/czk)	DPC/RRP (EUR)	EAN13
4CZ-5910-390	PZ2	65	25	15	37	1	386,78	16,12	8592667180918

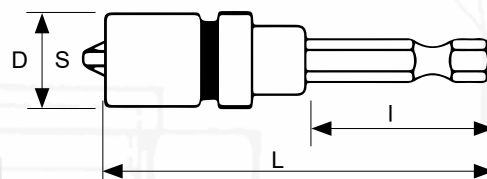

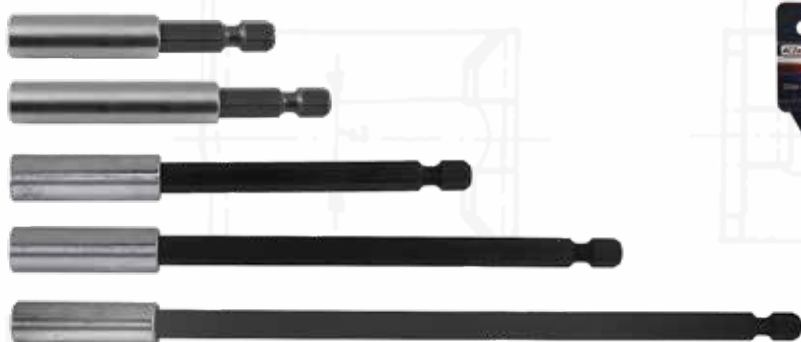

Držák bitů, magnetický 1/4"
Bit holder, magnetic, 1/4"
Bithalter, magnetisch, 1/4"

kód/Code Bestellnummer	L (mm)	I (mm)	A (mm)	W (g)		DPC/RRP (Kč/czk)	DPC/RRP (EUR)	EAN13
4CZ-8321-060	60	15	10	30	1	79,34	3,31	8592667180956
4CZ-8321-075	75	18	10	36	1	61,98	2,58	8592667191006
4CZ-8321-110	110	75	10	44	1	301,65	12,57	8592667180949
4CZ-8321-150	150	115	10	56	1	342,15	14,26	8592667180833
4CZ-8321-200	200	165	10	68	1	409,92	17,08	8592667180826

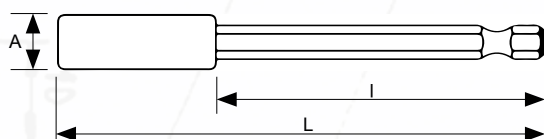

Držák bitů, nerezový 1/4"
Bit holder, inox, 1/4"
Bithalter, rostří, 1/4"

kód/Code Bestellnummer	L (mm)	I (mm)	A (mm)	W (g)		DPC/RRP (Kč/czk)	DPC/RRP (EUR)	EAN13
4CZ-8321-760	60	25	11	30	1	142,15	5,92	8592667180819

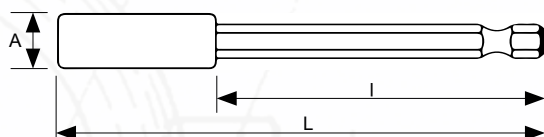

Držák bitů, magnetický, SDS+ x 84 mm
Bit holder, magnetic, SDS+ x 84 mm
Bithalter, magnetisch, SDS+ x 84 mm

kód/Code Bestellnummer	L (mm)	I (mm)	A (mm)	W (g)		DPC/RRP (Kč/czk)	DPC/RRP (EUR)	EAN13
4CZ-8321-840	78	50	11	43	1	275,21	11,47	8592667180932

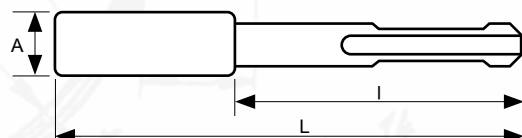

Držák bitů, magnetický, TEMPO, rychlospojka 1/4"
Bit holder, magnetic, TEMPO, quick coupler 1/4"
Bithalter, magnetisch, TEMPO, Schnellkupplung 1/4"

kód/Code Bestellnummer	L (mm)	I (mm)	A (mm)	W (g)		DPC/RRP (Kč/czk)	DPC/RRP (EUR)	EAN13
4CZ-8327-060	60	24	15	31	1	137,19	5,72	8592667180925

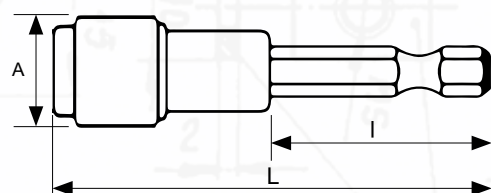

Držák bitů, magnetický, IMPACT-TEMPO, rychlospojka 1/4"
Bit holder, magnetic, IMPACT-TEMPO, quick coupler 1/4"
Bithalter, magnetisch, IMPACT-TEMPO, Schnellkupplung 1/4"

kód/Code Bestellnummer	L (mm)	I (mm)	A (mm)	W (g)		DPC/RRP (Kč/czk)	DPC/RRP (EUR)	EAN13
4CZ-8327-080	80	45	16	39	1	447,11	18,63	8592667180802

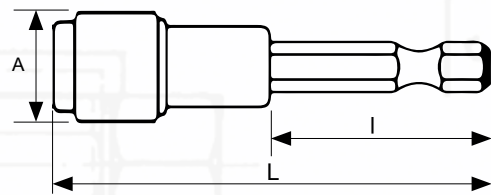



Držák bitů s pojistkou 1/4"
Quick release bit holder 1/4"
Bithalter mit Sicherung 1/4"

kód/Code Bestellnummer	L	I	A	W (g)	DPC/RRP (Kč/czk)	DPC/RRP (EUR)	EAN13
4CZ-8318-065	60	25	15	29	1	89,26	8592667190979
4CZ-8318-110	110	75	15	36	1	108,26	8592667190986
4CZ-8318-150	150	115	15	44	1	114,88	8592667190993

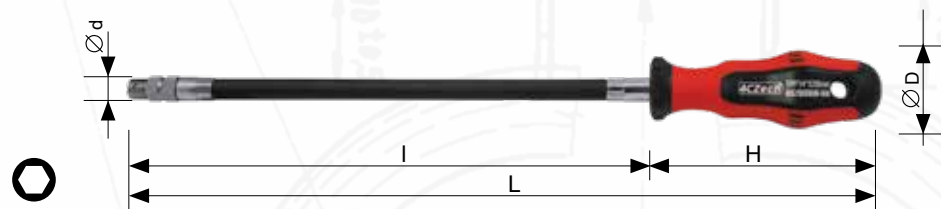
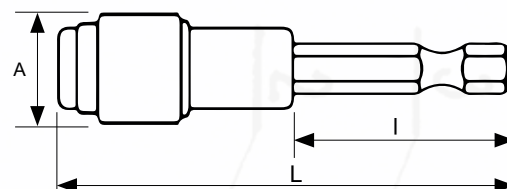

Držák bitů 1/4" FLEXI s rukojetí profi
Flexible driver 1/4" with handle profi
Bithalter FLEXI 1/4" mit Handgriff profi

kód/Code Bestellnummer	d (mm)	I (mm)	L (mm)	H (mm)	D (mm)	W (g)	DPC/RRP (Kč/czk)	DPC/RRP (EUR)	EAN13
4CZ-8323-10	10	170	270	100	35	137	12	136,36	8592667110922
4CZ-8323-11	10	250	350	100	35	160	12	199,17	8592667110939

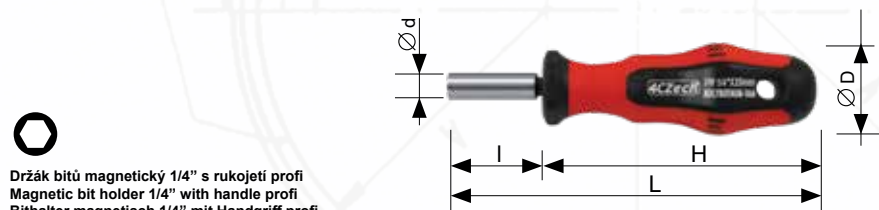

Držák bitů magnetický 1/4" s rukojetí profi
Magnetic bit holder 1/4" with handle profi
Bithalter magnetisch 1/4" mit Handgriff profi

kód/Code Bestellnummer	d (mm)	I (mm)	L (mm)	H (mm)	D (mm)	W (g)	DPC/RRP (Kč/czk)	DPC/RRP (EUR)	EAN13
4CZ-8320-09	10	35	135	100	35	70	12	121,49	8592667110885
4CZ-8320-10	10	70	170	100	35	83	12	127,27	8592667110892

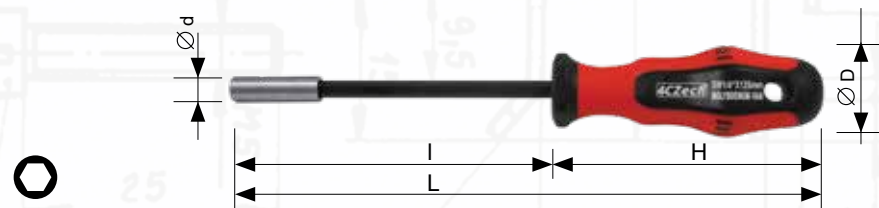

Držák bitů magnetický 1/4" s rukojetí profi
Magnetic bit holder 1/4" with handle profi
Bithalter magnetisch 1/4" mit Handgriff profi

kód/Code Bestellnummer	d (mm)	I (mm)	L (mm)	H (mm)	D (mm)	W (g)	DPC/RRP (Kč/czk)	DPC/RRP (EUR)	EAN13
4CZ-8367-00	10	125	225	100	35	101	12	217,36	8592667110946

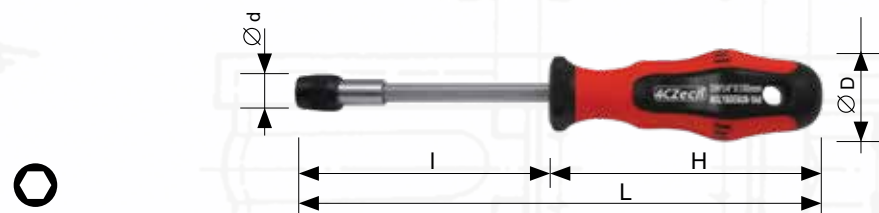

Držák bitů 1/4" s rukojetí s pojistkou profi
Quick release 1/4" with handle profi
Bithalter 1/4" mit Handgriff mit Sicherung profi

kód/Code Bestellnummer	d (mm)	I (mm)	L (mm)	H (mm)	D (mm)	W (g)	DPC/RRP (Kč/czk)	DPC/RRP (EUR)	EAN13
4CZ-8320-18	18	35	135	100	35	75	12	158,68	8592667110908
4CZ-8320-19	19	100	200	100	35	100	12	192,56	8592667110915



i Uloženo v praktickém boxu z odolného plastu s praktickou sponou na opasek.
Stored in a practical box made of durable plastic with a practical belt clip.
Aufbewahrt in praktischer Box aus strapazierfähigem Kunststoff mit praktischem Gürtelclip.



Sada bitů 1/4"-25mm v krabičce 15ks
Bit set 1/4"-25mm in a box 15pcs
Bitsatz 1/4"-25mm in Schachtel 15 Stk.

kód/Code Bestellnummer	W (g)	1	DPC/RRP (Kč/czk)	DPC/RRP (EUR)	EAN13
4CZ-8504-15	177	1	241,32	10,06	8592667191105

velikost / size / Größe
55x90x40mm

typ/type	obsah / content / Inhalt
1/4" bit plochý 25mm / Bit slotted 25mm / Bit Schlitz 25mm	SL4, SL5, SL6
1/4" bit křížový phillips 25mm / bit phillips 25mm / Bit Phillips 25mm	PH1, PH2, PH3
1/4" bit křížový pozidrive 25mm / bit pozidrive 25mm / Bit Pozidriv 25mm	PZ1, PZ2, PZ3
1/4" bit TRX 25mm / T-Star Bit 25mm / Bit TORX 25mm	T15, T20, T25, T30, T40
držák bitů 1/4" s pojistkou magnetický / Quick release bit holder 1/4" magnetic / Bithalter mit Sicherung 1/4" magnetisch	65mm



Sada bitů 1/4"-25mm v krabičce 32ks
Bit set 1/4"-25mm in a box 32pcs
Bitsatz 1/4"-25mm in Schachtel 32 Stk.

kód/Code Bestellnummer	W (g)	1	DPC/RRP (Kč/czk)	DPC/RRP (EUR)	EAN13
4CZ-8504-32	318	1	395,87	16,49	8592667191112

velikost / size / Größe
105x75x45mm

typ/type	obsah / content / Inhalt
1/4" bit plochý 25mm / Bit slotted 25mm / Bit Schlitz 25mm	SL3, SL4, SL5, SL6
1/4" bit křížový phillips 25mm / bit phillips 25mm / Bit Phillips 25mm	PH1, PH2, PH2, PH3
1/4" bit křížový pozidrive 25mm / bit pozidrive 25mm / Bit Pozidriv 25mm	PZ1, PZ2, PZ2, PZ3
1/4" bit TRX 25mm / T-Star Bit 25mm / Bit TORX 25mm	T10, T15, T20, T25, T27, T30, T40
1/4" bit TRX s otvorem 25mm / T-Star Bit tamperproof 25mm / Bit TORX mit Loch 25mm	TT10, TT15, TT20, TT25, TT27, TT30, TT40
1/4" bit šestihranný imbus 25mm / bit hexagon imbus 25mm / Bit Sechskant Imbus 25mm	H3, H4, H5, H6
1/4" adaptér / adapter / Adapter	25mm
držák bitů 1/4" s pojistkou magnetický / Quick release bit holder 1/4" magnetic / Bithalter mit Sicherung 1/4" magnetisch	65mm



i Uloženo v praktickém boxu z odolného plastu s praktickou sponou na opasek.

Stored in a practical box made of durable plastic with a practical belt clip.

Aufbewahrt in praktischer Box aus strapazierfähigem Kunststoff mit praktischem Gürtelclip.



Sada bitů 1/4"-25mm v krabičce 42ks
Bit set 1/4"-25mm in a box 42pcs
Bitsatz 1/4"-25mm in Schachtel 42 Stk.

kód/Code Bestellnummer	W (g)	1	DPC/RRP (Kč/czk)	DPC/RRP (EUR)	EAN13
4CZ-8504-42	416	1	422,31	17,60	8592667191129

velikost / size / Größe
130x95x45mm

typ/type	obsah / content / Inhalt
1/4" bit plochý 25mm / Bit slotted 25mm / Bit Schlitz 25mm	SL3, SL4, SL5, SL6, SL8
1/4" bit křížový phillips 25mm / bit phillips 25mm / Bit Phillips 25mm	PH0, PH1, PH2, PH3
1/4" bit křížový pozidrive 25mm / bit pozidrive 25mm / Bit Pozidriv 25mm	PZ0, PZ1, PZ2, PZ3
1/4" bit TRX 25mm / T-Star Bit 25mm / Bit TORX 25mm	T10, T15, T20, T25, T27, T30, T40
1/4" bit TRX s otvorem 25mm / T-Star Bit tamperproof 25mm / Bit TORX mit Loch 25mm	TT10, TT15, TT20, TT25, TT27, TT30, TT40
1/4" bit šestihranný imbus 25mm / bit hexagon imbus 25mm / Bit Sechskant Imbus 25mm	H1,5 H2, H2,5, H3, H4, H5, H6, H8
1/4" bit čtyřhranný 25mm / Square Bit 25mm / Bit 4-kant 25mm	SQ2
1/4" bit tříkřídlový 25mm / Tri-Wing Bit 25mm / Bit Tri-Wing 25mm	Y4, Y5
1/4" bit klíčový 25mm / Spanner Bit 25mm / Bit U-Form 25mm	U4, U6
1/4" adaptér / adapter / Adapter	25mm
držák bitů 1/4" s pojistkou magnetický / Quick release bit holder 1/4" magnetic / Bithalter mit Sicherung 1/4" magnetisch	65mm

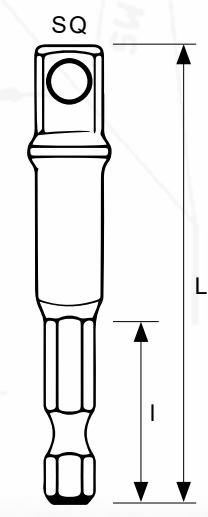

Adaptér 6HR 1/4" x 4HR
Adapter HEX 1/4" x SQ
Adapter 6-kant 1/4" x 4-Kant

kód/Code Bestellnummer	S	L	I	W (g)	1	DPC/RRP (Kč/czk)	DPC/RRP (EUR)	EAN13
4CZ-8329-02	SQ1/4"	25	11	24	2	37,52	1,56	8592667191013
4CZ-8329-05	SQ1/4"	50	25	14	1	28,76	1,20	8592667180796
4CZ-8329-06	SQ1/4"	65	25	28	1	39,67	1,65	8592667191020
4CZ-8329-07	SQ3/8"	65	25	35	1	43,80	1,83	8592667191037
4CZ-8329-08	SQ1/2"	72	25	54	1	52,07	2,17	8592667191044

Uvedené ceny jsou DPC (doporučené prodejní ceny) v Kč a EUR bez DPH.
All prices mentioned are DPC (RRP - recommended retail price) in CZK and EUR without VAT.
Alle Preise sind EV-Preise (empfohlene Verkaufspreise) in CZK and EUR ohne MwSt.



Nástavec maticový 1/4" magnetický, délka 65mm
Nut setter 1/4" magnetic, length 65mm
Muttereinsatz 1/4" magnetisch, Länge 65mm

kód/Code Bestellnummer	S (mm)	L	I	W (g)	 DPC/RRP (Kč/czsk)	DPC/RRP (EUR)	EAN13
4CZ-8386-55	5	65	25	28	1	69,42	8592667180895
4CZ-8386-56	6	65	25	33	1	71,90	8592667180888
4CZ-8386-57	7	65	25	34	1	71,90	8592667180871
4CZ-8386-58	8	65	25	40	1	75,21	8592667180864
4CZ-8386-60	10	65	25	43	1	76,86	8592667180857
4CZ-8386-63	13	65	25	57	1	82,64	8592667180840
4CZ-8386-64	14	65	25	61	1	80,99	8592667191099

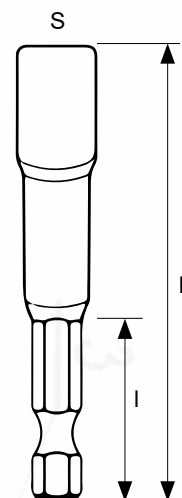

Sada maticových nástavců 5-dílná 6;7;8;10;13mm
Nut setter set, 5 pcs - 6; 7; 8; 10; 13 mm
Muttervereinsatz-Satz 5-teilig 6; 7; 8; 10; 13 mm

kód/Code Bestellnummer	W (g)	velikost / size / Größe	 DPC/RRP (Kč/czsk)	DPC/RRP (EUR)	EAN13
4CZ-8573-00	271	85x155x35mm	1	447,11	8592667180772



Kód / Code / Bestellnummer

4CZ-SV

Industry
line



POUŽITÍ

Dílenský svěrák se základnou otočnou o 360°, z tvárné litiny s kuličkovým grafitem. Čelisti z vysoce kvalitní uhlíkové oceli s dvojitým žebrováním kalené na 45HRC. Válcové vedení, kalené čelisti, kovadlina a bezpečnostní koncovky vratidla i klíček. Fixace polohy svěráku k základně klíčkami. Tři otvory pro upnutí na stůl pomocí šroubů, případně upnutí svěrkou u provedení HANDY.



USABILITY

Workshop vice with 360° rotatable base, made of ductile iron with nodular graphite. Jaws made of high-quality double-ribbed carbon steel hardened to 45HRC. Cylindrical guide, hardened jaws, anvil and safety ends of the beam and the handle. Fixing the position of the vice to the base with loops. Three holes for fastening to the table with screws, or clamping with a clamp for the HANDY version.



VERWENDUNG

Werkstattsschraubstock mit um 360° drehbarer Basis, hergestellt aus Sphäroguss mit Kugelgraphit. Backen aus hochwertigem Kohlenstoffstahl mit Doppelrippung, gehärtet auf 45 HRC. Rollenführungen, gehärtete Backen, Amboss und Sicherheitsendkappen für Spindel und Griffe. Fixierung der Schraubstockposition an der Basis durch Kurbeln. Drei Bohrungen für die Befestigung auf dem Tisch mit Schrauben oder mit Klemmen in der Version HANDY.

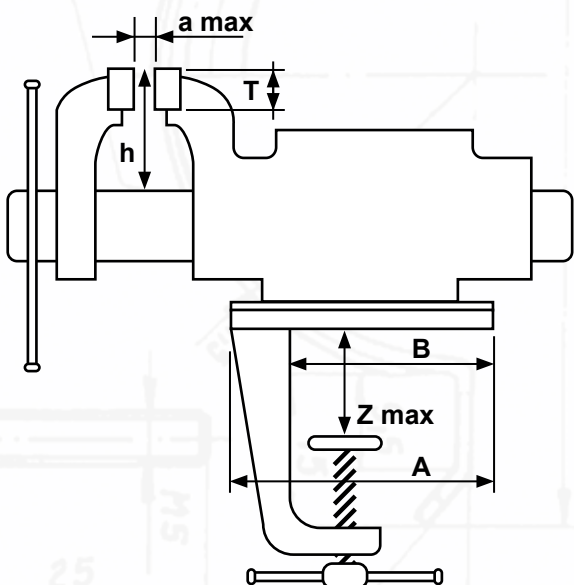
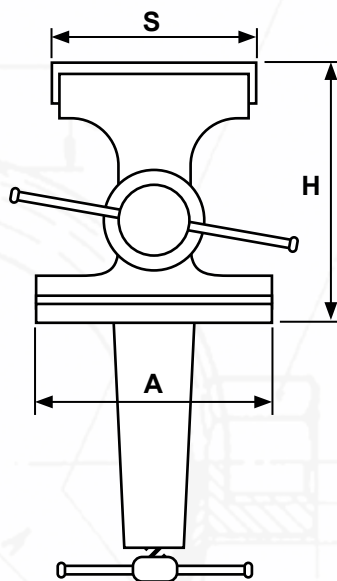
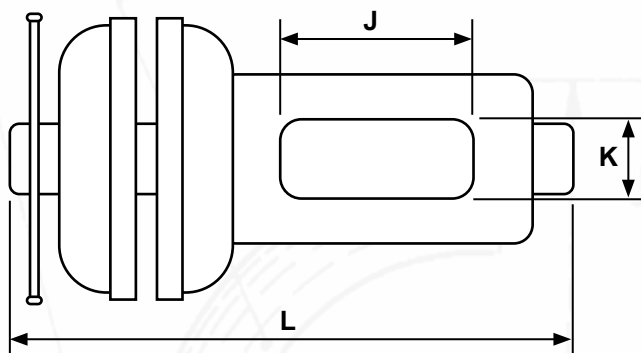

Svěrák dílenský, Handy Lux
Workshop vice, Handy Lux
Schraubstock, Handy Lux

kód/Code Bestellnummer	S (mm)	a max (mm)	h (mm)	T (mm)	H (mm)	L (mm)	A (mm)	B (mm)	Z max (mm)	J (mm)	K (mm)	W (g)	DPC/RRP (Kč/czkk) 1395,87	DPC/RRP (EUR) 58,16	EAN13 8592667203655
4CZ-SV-HL063	70	70	48	19	117	227	118	105	52	66	29	5234			

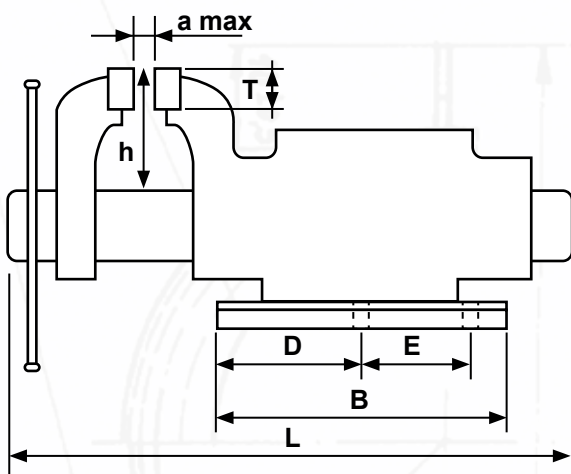
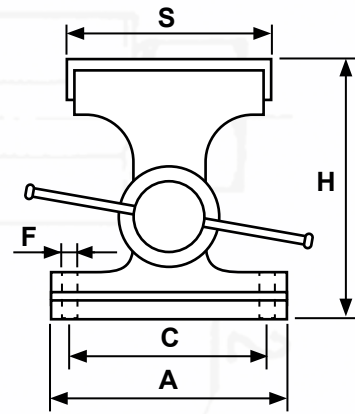
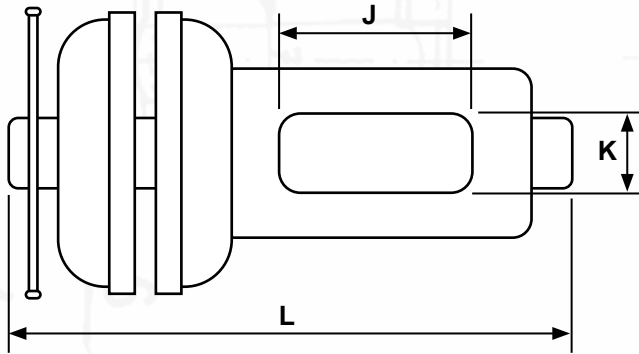

Svěrák dílenský, Lux
Workshop vice, Lux
Schraubstock, Lux

kód/Code Bestellnummer	S (mm)	a max (mm)	h (mm)	T (mm)	H (mm)	L (mm)	A (mm)	B (mm)	C (mm)	D (mm)	E (mm)	F (mm)	J (mm)	K (mm)	W (g)		DPC/RRP (Kč/czk)	DPC/RRP (EUR)	EAN13
4CZ-SV-L080	84	90	51	18	133	246	159	145	136	67	68	10	80	36	6450	1	1693,39	70,56	8592667203662
4CZ-SV-L100	110	115	78	23	171	333	190	172	166	80	83	10	96	49	13875	1	2817,36	117,39	8592667203679
4CZ-SV-L125	133	140	85	24	208	380	240	223	208	104	105	10	117	58	22300	1	4015,70	167,32	8592667203686
4CZ-SV-L150	154	160	96	23	228	430	250	233	224	112	110	10	139	63	27900	1	5949,59	247,90	8592667203693



Čelist pro svěrák 4CZech - 45HRC (pár)
Spare jaw for vice 4CZech - 45HRC (pair)
Ersatzbacke für Schraubstock 4CZech - 45HRC (Paar)

kód/Code Bestellnummer		DPC/RRP (Kč/czck)	DPC/RRP (EUR)	EAN13
4CZ-SVND-HL063-CP	1	139,67	5,82	8592667204324
4CZ-SVND-L080-CP	1	169,42	7,06	8592667204386
4CZ-SVND-L100-CP	1	281,82	11,74	8592667204447
4CZ-SVND-L125-CP	1	401,65	16,74	8592667204508
4CZ-SVND-L150-CP	1	595,04	24,79	8592667204560



Kompletní vřeteno (šroub) pro svěrák 4CZech
Complete spindle (screw) for vice 4CZech
Komplette Spindel für Schraubstock (Schraube) 4CZech

kód/Code Bestellnummer		DPC/RRP (Kč/czck)	DPC/RRP (EUR)	EAN13
4CZ-SVND-HL063-KV	1	252,07	10,50	8592667204348
4CZ-SVND-L080-KV	1	304,96	12,71	8592667204409
4CZ-SVND-L100-KV	1	507,44	21,14	8592667204461
4CZ-SVND-L125-KV	1	723,14	30,13	8592667204522
4CZ-SVND-L150-KV	1	1071,07	44,63	8592667204584



Přední díl pro svěrák 4CZech
Front pc spare part for vice 4CZech
Vorderteil für Schraubstock 4CZech

kód/Code Bestellnummer		DPC/RRP (Kč/czck)	DPC/RRP (EUR)	EAN13
4CZ-SVND-HL063-PD	1	447,11	18,63	8592667204355
4CZ-SVND-L080-PD	1	542,15	22,59	8592667204416
4CZ-SVND-L100-PD	1	901,65	37,57	8592667204478
4CZ-SVND-L125-PD	1	1285,12	53,55	8592667204539
4CZ-SVND-L150-PD	1	1904,13	79,34	8592667204591



Tělo s maticí pro svěrák 4CZech
Back pc spare part with nut for vice 4CZech
Körper mit Mutter für Schraubstock 4CZech

kód/Code Bestellnummer		DPC/RRP (Kč/czck)	DPC/RRP (EUR)	EAN13
4CZ-SVND-HL063-TM	1	670,25	27,93	8592667204362
4CZ-SVND-L080-TM	1	813,22	33,88	8592667204423
4CZ-SVND-L100-TM	1	1352,89	56,37	8592667204485
4CZ-SVND-L125-TM	1	1928,10	80,34	8592667204546
4CZ-SVND-L150-TM	1	2856,20	119,01	8592667204607



Základna pro svěrák 4CZech HL
Base for vice 4CZech HL
Basis für Schraubstock 4CZech HL

kód/Code Bestellnummer		DPC/RRP (Kč/czck)	DPC/RRP (EUR)	EAN13
4CZ-SVND-HL063-ZS	1	279,34	11,64	8592667204331



Základna pro svěrák 4CZech L
Base for vice 4CZech L
Basis für Schraubstock 4CZech L

kód/Code Bestellnummer		DPC/RRP (Kč/czck)	DPC/RRP (EUR)	EAN13
4CZ-SVND-L080-ZS	1	338,84	14,12	8592667204393
4CZ-SVND-L100-ZS	1	563,64	23,48	8592667204454
4CZ-SVND-L125-ZS	1	803,31	33,47	8592667204515
4CZ-SVND-L150-ZS	1	1190,08	49,59	8592667204577



Klička upínací pro svěrák 4CZech
Clamping handle for vice 4CZech
Spanngriff für Schraubstock 4CZech

kód/Code Bestellnummer		DPC/RRP (Kč/czck)	DPC/RRP (EUR)	EAN13
4CZ-SVND-HL063-KU	1	70,25	2,93	8592667204379
4CZ-SVND-L080-KU	1	85,12	3,55	8592667204430
4CZ-SVND-L100-KU	1	141,32	5,89	8592667204492
4CZ-SVND-L125-KU	1	200,83	8,37	8592667204553
4CZ-SVND-L150-KU	1	297,52	12,40	8592667204614



Fixace vřetene pro svěrák 4CZech
Spindle fixation for vice 4CZech
Spindelfixierung für Schraubstock 4CZech

kód/Code Bestellnummer		DPC/RRP (Kč/czck)	DPC/RRP (EUR)	EAN13
4CZ-SVND-HL063-FV	1	35,54	1,48	8592667204621
4CZ-SVND-L080-FV	1	42,98	1,79	8592667204638
4CZ-SVND-L100-FV	1	71,07	2,96	8592667204645
4CZ-SVND-L125-FV	1	100,83	4,20	8592667204652
4CZ-SVND-L150-FV	1	148,76	6,20	8592667204669



Značka **Geprüfte Sicherheit** neboli **GS** je dobrovolná certifikační značka pro technická zařízení. Označuje, že zařízení splňuje německé a pokud jsou k dispozici, evropské bezpečnostní požadavky na taková zařízení.

The **Geprüfte Sicherheit** or **GS** mark is a voluntary certification mark for technical equipment. It indicates that the equipment meets German and, if available, European safety requirements for such devices.

Die **Geprüfte Sicherheit** oder **GS**-Marke ist eine freiwillige Zertifizierungsmarke für technische Geräte. Es zeigt an, dass die Geräte den deutschen und wenn vorhanden europäischen Sicherheitsanforderungen für solche Geräte entsprechen.



ID 7099

www.vpa-zert.de



VPA Prüf- und Zertifizierungs GmbH

Certifikátem **GS** potvrzujeme shodu s německými bezpečnostními normami. Je to přední bezpečnostní značka v Evropě a je udělována zejména pro ruční a zahradní nářadí.

Certifikace obsahuje

- Kompletní testování podle všech platných norem a směrnic.
- Rozsáhlé, nepřetržité sledování produktů.
- Důraz je kladen na bezpečnost.
- Vysoká akceptace spotřebitelů a vysoká úroveň povědomí.

VPA Prüf- und Zertifizierungs GmbH

With the **GS** certificate, we confirm compliance with German safety standards. It is the leading safety mark in Europe and is awarded mainly for hand and garden tools. Certification includes:

- Full testing according to all applicable standards and guidelines.
- Extensive, continuous product monitoring.
- The emphasis is on safety.
- High consumer acceptance and high level of awareness.

VPA Prüf- und Zertifizierungs GmbH

Mit dem **GS**-Siegel testieren wir Ihnen die Einhaltung deutscher Sicherheitsstandards. Es ist das führende Sicherheitszeichen in Europa und wird von der VPA insbesondere für Hand- und Gartenwerkzeuge vergeben. Die Zertifizierung beinhaltet

- Vollumfängliche Prüfung nach allen anwendbaren Normen und Richtlinien.
- Umfangreiche, kontinuierliche Überwachung der Produkte.
- Fokus liegt auf Sicherheit.
- Hohe Verbraucherakzeptanz und ein hoher Bekanntheitsgrad.



Kleště jsou nástroje, které využívají principu rozsáhlé přeměny síly. Jsou navrženy tak, aby plnily velmi specifické funkce. Výhodou je zvýšení efektivity a snížení únavy ruky, rizika zranění a používají se pro jednodušší a bezpečnější práci. Vyznačují se dlouhou životností. Náš testovací proces zahrnuje: Testování rázové houževnatosti za studena, testování přilnavosti, testování hořlavosti, testování izolačního odporu a testování dielektrika. (VPA/ GS/ VDE/ DIN IEC 60900).

Pliers are tools that get used through extensive force conversion. Pliers are designed to serve very specific functions. In most cases, the plier is a tool engineered to increase the effectiveness of the hand, reducing hand fatigue, risks of injuries and making work easier and safer. Users expect long service life. Our testing process includes; Cold impact strength testing, adhesiveness testing, combustibility testing, insulation resistance testing and dielectric testing. (VPA/ GS/ VDE/ DIN IEC 60900).

Zangen sind Werkzeuge, die durch umfangreiche Kraftumwandlung missbraucht werden. Zangen sind so konzipiert, dass sie ganz bestimmte Funktionen erfüllen. In den meisten Fällen ist die Zange ein Werkzeug, das entwickelt wurde, um die Effektivität der Hand zu erhöhen, die Ermüdung der Hand und das Verletzungsrisiko zu verringern und die Arbeit einfacher und sicherer zu machen. Anwender erwarten eine lange Lebensdauer. Unser Testprozess umfasst: Kälteschlagfestigkeitstestprüfung, Haftfestigkeitstestprüfung, Brennbarkeitstestprüfung, Isolationswiderstandstestprüfung und dielektrische Prüfung. (VPA/ GS/ VDE/ DIN IEC 60900).



Kód / Code / Bestellnummer

4CZ-351

Industry
line

Cr-Mo

DIN
ISO
5746



POUŽITÍ

Kompaktní kombinované kleště z chrom-molybdenové oceli, kované a kalené do oleje. Vhodné k použití v domácích dílnách i pro řemeslníky pro práci s plochým i kruhovým materiálem. Štípací břity pro drát jsou dodatečně indukčně kalené a zajišťují čistý řez pro drát měkký i s vysokou pevností v tahu. Přesný nýtovaný spoj zaručuje mimořádně hladký pohyb bez boční vůle. Provedení překračuje standardy ASME (profesionální a průmyslové).



USABILITY

Compact combination pliers made of chrome-molybdenum steel, forged and oil-hardened. Appropriate for use in home workshops and for craftsmen for work with flat and round material. Splitting edges for wires are induction hardened additionally. They also ensure a clean cut for soft wire as well as wire with high tensile strength. The precise riveted joint guarantees extraordinary smooth movement without side play. The design exceeds ASME standards (professional and industrial).



VERWENDUNG

Kompakte Kombizange aus Chrom-Molybdän-Stahl, geschmiedet und ölgehärtet. Geeignet für den Einsatz in Bastelwerkstätten aber auch für Handwerker zur Bearbeitung vom Flach- und Rundmaterial. Die Schneiden für Draht sind zusätzlich induktiv gehärtet und gewährleisten einen präzisen Schnitt sowohl für weiche Drähte als auch für Drähte mit hoher Zugfestigkeit. Präzise Nietverbindung garantiert eine extrem leichte Bewegung ohne Seitenspiel. Die Ausführung übertrifft die ASME-Normen (professionelle und industrielle).

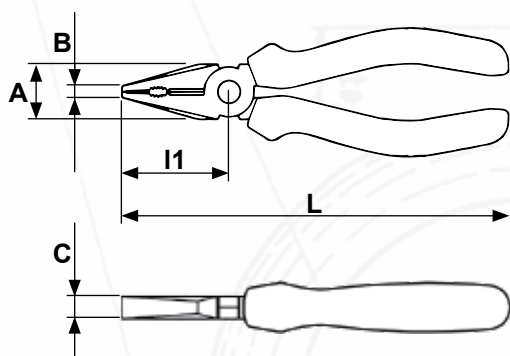

Kleště kombinované DIN ISO 5746
All purpose pliers DIN ISO 5746
Kombizange DIN ISO 5746

kód/Code Bestellnummer	L (mm)	I1 (mm)	A (mm)	B (mm)	C (mm)	M (mm)	H (mm)	W (g)			DPC/RRP (Kč/czk)	DPC/RRP (EUR)	EAN13
4CZ-351-160PVC	171	46,0	24,0	7,0	10,0	3,1	2,0	219	•	10	447,11	18,63	8592667164383
4CZ-351-180PVC	184	51,0	27,0	7,5	11,0	3,4	2,2	274	•	10	499,17	20,80	8592667164390
4CZ-351-200PVC	211	56,0	30,5	8,0	12,0	3,8	2,5	368	•	5	613,22	25,55	8592667164406



M - střední drát / medium wire / mittlerer Draht
H - tvrdý drát / hard wire / harter Draht

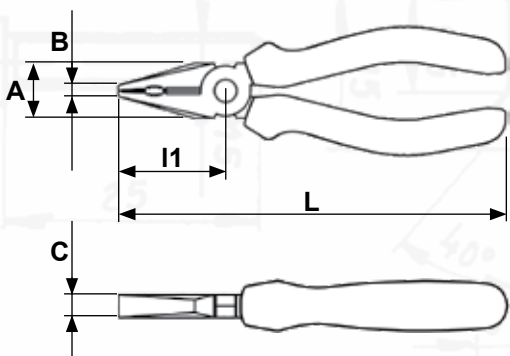

Kleště kombinované DIN ISO 5746 s funkcí krimpování koncovek
Combination pliers DIN ISO 5746 with end crimping function
Kombizange DIN ISO 5746 mit Funktion Crimpen von Klemmen

kód/Code Bestellnummer	L (mm)	I1 (mm)	A (mm)	B (mm)	C (mm)	M (mm)	W (g)		DPC/RRP (Kč/czk)	DPC/RRP (EUR)	EAN13
4CZ-351-220PH	220	57,0	26,3	7,5	14,2	1,6	413	5	857,02	35,71	8592667164413



M - střední drát / medium wire / mittlerer Draht



Kód / Code / Bestellnummer

4CZ-335

Industry
line

Cr-Mo

DIN
ISO
5749



POUŽITÍ

Štípací kleště z chrom-molybdenové oceli, kované a kalené do oleje. Vhodné k použití v domácích dílnách i pro řemeslníky. Štípací břity jsou dodatečně indukčně kalené a zajistí čistý řez pro drát měkký i s vysokou pevností v tahu. Úzká hlava kleští usnadní práci v omezeném prostoru. Přesný nýtovaný spoj zaručuje mimořádně hladký pohyb bez boční vůle.



USABILITY

Side cutting pliers made of chrome-molybdenum steel, forged and oil-hardened. Appropriate for use in home workshops and for craftsmen. Splitting edges are induction hardened additionally. They also ensure a clean cut for soft wire as well as wire with high tensile strength. The narrow head of the pliers makes it easier to work in limited space. The precise riveted joint guarantees extraordinary smooth movement without side play.



VERWENDUNG

Kneifzange aus Chrom-Molybdän-Stahl, geschmiedet und ölgehärtet. Geeignet für den Einsatz in Bastelwerkstätten aber auch für Handwerker. Die Schneiden für Draht sind zusätzlich induktiv gehärtet und gewährleisten einen präzisen Schnitt sowohl für weiche Drähte als auch für Drähte mit hoher Zugfestigkeit. Schmalere Kopf der Zange erleichtert das Arbeiten in beengtem Raum. Präzise Nietverbindung garantiert eine extrem leichte Bewegung ohne Seitenspiel.

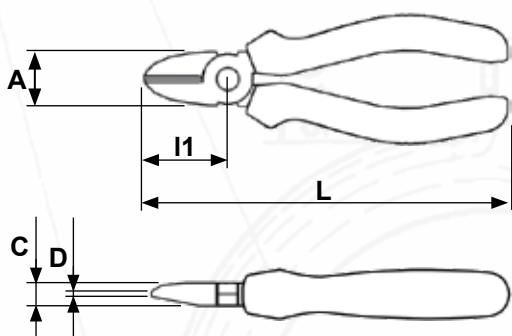

S - měkký drát / soft wire / weicher Draht
M - střední drát / medium wire / mittlerer Draht
H - tvrdý drát / hard wire / harter Draht

Kleště štípací boční DIN ISO 5749
Side cutting pliers DIN ISO 5749
Seitenschneider DIN ISO 5749

kód/Code Bestellnummer	L (mm)	I1 (mm)	A (mm)	C (mm)	D (mm)	S (mm)	M (mm)	H (mm)	W (g)			DPC/RRP (Kč/czk)	DPC/RRP (EUR)	EAN13
4CZ-335-125PVC	141	28,0	19,0	9,1	1,7	4,0	2,5	1,8	145			410,74	17,11	8592667164352
4CZ-335-160PVC	160	28,0	20,0	10,3	2,3	4,0	2,8	2,0	193			468,60	19,52	8592667164369



Kód / Code / Bestellnummer

4CZ-304

Industry
line

Cr-Mo

DIN
ISO
9243



POUŽITÍ

Štípací kleště z chrom-molybdenové oceli, kované. Ideální tvar pro tahání a stříhání hřebíků ve vertikální poloze. Vhodné pro použití v domácích dílnách, stavebnictví a pro řemeslníky. Břity s vysokou odolností proti opotřebení jsou dodatečně indukčně kalené a zajistí čistý řez pro drát měkký i s vysokou pevností v tahu. Přesný nýtovaný spoj zaručuje mimořádně hladký pohyb bez boční vůle.



USABILITY

Carpenter's pincers made of chrome-molybdenum steel, forged. Ideal shape for pulling and cutting nails in a vertical position. Appropriate for use in home workshops and for craftsmen. Splitting edges with high wear resistance are induction hardened additionally and also ensure a clean cut for soft wire as well as wire with high tensile strength. The precise riveted joint guarantees extraordinary smooth movement without side play.



VERWENDUNG

Kneifzange aus Chrom-Molybdän-Stahl, geschmiedet. Ideale Form zum Ziehen und Schneiden von Nageln in der vertikalen Position. Geeignet für den Einsatz in Bastelwerkstätten, im Bauwesen und für Handwerker. Die Schneiden mit hoher Verschleißfestigkeit sind zusätzlich induktiv gehärtet und gewährleisten einen präzisen Schnitt sowohl für weiche Drähte als auch für Drähte mit hoher Zugfestigkeit. Präzise Nietverbindung garantiert eine extrem leichte Bewegung ohne Seitenspiel.

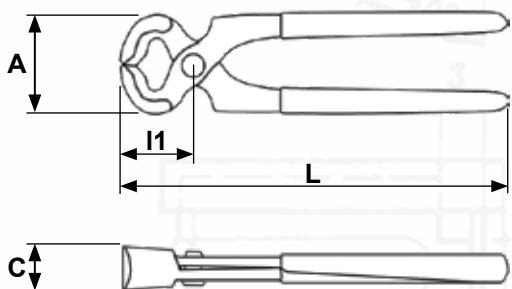

M - střední drát / medium wire / mittlerer Draht

Kleště štípací čelní DIN ISO 9243
Carpenter's pincers DIN ISO 9243
Kneifzange DIN ISO 9243

kód/Code Bestellnummer	L (mm)	I1 (mm)	A (mm)	C (mm)	M (mm)	W (g)		DPC/RRP (Kč/czk)	DPC/RRP (EUR)	EAN13
4CZ-304-180PH	182	33,0	49,4	18,2	2,0	273		525,62	21,90	8592667164246
4CZ-304-200PH	200	36,5	52,0	24,5	2,2	405		657,85	27,41	8592667164253



Kód / Code / Bestellnummer
4CZ-310, 4CZ-310P

Industry
line

Cr-Mo

DIN
ISO
5748



POUŽITÍ

Štípací kleště z chrom-molybdenové oceli, kované. Tvar hlavy kleští usnadní práci v omezeném prostoru. Vhodné pro průmyslové použití i v domácích dílnách, stavebnictví a pro řemeslníky. Štípací břity s vysokou odolností proti opotřebení jsou dodatečně indukčně kalené a zajistí čistý řez pro drát měkký i s vysokou pevností v tahu. Přesný nýtovaný spoj zaručuje mimořádně hladký pohyb bez boční vůle.



USABILITY

Carpenter's pincers made of chrome-molybdenum steel, forged. The head shape of the pliers makes it easier to work in limited space. Suitable for industrial use as well as in home workshops, construction and for craftsmen. Splitting edges with high wear resistance are induction hardened additionally and also ensure a clean cut for soft wire as well as wire with high tensile strength. The precise riveted joint guarantees extraordinary smooth movement without side play.



VERWENDUNG

Kneifzange aus Chrom-Molybdän-Stahl, geschmiedet. Die Kopfform der Zange erleichtert das Arbeiten in beengtem Raum. Geeignet für den Einsatz in der Industrie aber auch in Bastelwerkstätten, im Bauwesen und für Handwerker. Die Schneiden mit hoher Verschleißfestigkeit sind zusätzlich induktiv gehärtet und gewährleisten einen präzisen Schnitt sowohl für weiche Drähte als auch für Drähte mit hoher Zugfestigkeit. Präzise Nietverbindung garantiert eine extrem leichte Bewegung ohne Seitenspiel.

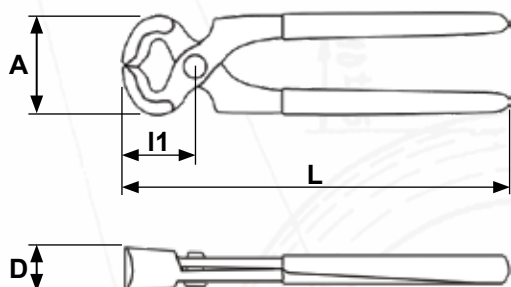

Kleště štípací čelní DIN ISO 5748
Carpenter's pincers DIN ISO 5748
Kneifzange DIN ISO 5748

kód/Code Bestellnummer	L (mm)	I1 (mm)	A (mm)	D (mm)	S (mm)	M (mm)	H (mm)	W (g)	DPC/RRP (Kč/czk)	DPC/RRP (EUR)	EAN13	
4CZ-310-160PH	159	16,0	31,5	25,0	4,0	2,8	2,3	208	6	479,34	19,97	8592667164260
4CZ-310-180PH	180	17,0	40,0	29,0	4,0	3,2	2,5	300	6	580,17	24,17	8592667164277
4CZ-310-200PH	200	18,0	40,0	32,0	4,0	3,5	2,8	340	6	647,11	26,96	8592667164284



S - měkký drát / soft wire / weicher Draht
M - střední drát / medium wire / mittlerer Draht
H - tvrdý drát / hard wire / harter Draht

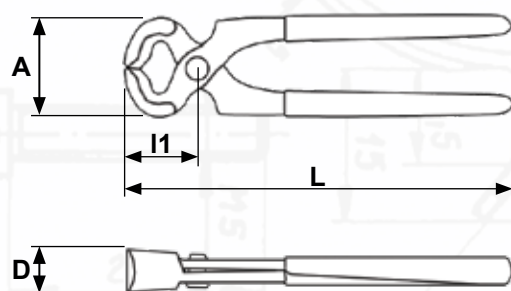

Kleště štípací čelní precizní DIN ISO 5748
End cutting nippers DIN ISO 5748
Präzisions-Kneifzange DIN ISO 5748

kód/Code Bestellnummer	L (mm)	I1 (mm)	A (mm)	D (mm)	M (mm)	H (mm)	P (mm)	W (g)	DPC/RRP (Kč/czk)	DPC/RRP (EUR)	EAN13	
4CZ-310P-160PVC	171	16,0	30,0	24,0	3,4	2,0	1,6	253	6	518,18	21,59	8592667164307



M - střední drát / medium wire / mittlerer Draht
H - tvrdý drát / hard wire / harter Draht
P - pianový drát / piano wire / Piano Draht



Kód / Code / Bestellnummer

4CZ-2313

Industry
line

Cr-Mo

DIN
ISO
9242



POUŽITÍ

Armovací kleště z chrom-molybdenové oceli, kované. Štípací břity s vysokou odolností proti opotřebení jsou dodatečně indukčně kalené. Použití ve stavebnictví i v domácích dílnách pro kroucení a stříhání železných armatur. Tvar hlavy kleští usnadní použití v omezeném prostoru. Přesný nýtovaný spoj zaručuje mimořádně hladký pohyb bez boční vůle.



USABILITY

Reinforcement pliers made of chrome-molybdenum steel, forged. Splitting edges with high wear resistance are induction hardened additionally. Use in the construction industry and in home workshops for twisting and cutting iron fittings. The head shape of the pliers makes it easier to work in limited space. The precise riveted joint guarantees extraordinary smooth movement without side play.



VERWENDUNG

Rabitzzange aus Chrom-Molybdän-Stahl, geschmiedet. Die Schneiden mit hoher Verschleißfestigkeit sind zusätzlich induktiv gehärtet. Für den Einsatz im Bauwesen aber auch in Bastelwerkstätten zum Verdrehen und Schneiden von Eisenarmaturen. Die Kopfform der Zange erleichtert das Arbeiten in beengtem Raum. Präzise Nietverbindung garantiert eine extrem leichte Bewegung ohne Seitenspiel.

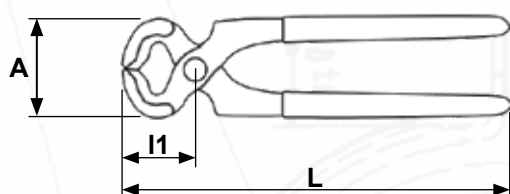

M - střední drát / medium wire / mittlerer Draht
H - tvrdý drát / hard wire / harter Draht

Kleště armovací DIN ISO 9242
Reinforced pliers DIN ISO 9242
Rabitzzangen DIN ISO 9242

kód/Code Bestellnummer	L (mm)	I1 (mm)	A (mm)	D (mm)	M (mm)	H (mm)	W (g)	DPC/RRP (Kč/czk)	DPC/RRP (EUR)	EAN13	
4CZ-2313-230PH	219	26	30,0	23,0	2,4	1,6	342	6	566,94	23,62	8592667164000
4CZ-2313-250PH	251	31	35,0	26,0	2,4	1,6	407	6	596,69	24,86	8592667164017
4CZ-2313-280PH	281	31	35,0	26,0	2,8	1,8	477	6	610,74	25,45	8592667164024



Kód / Code / Bestellnummer

4CZ-366, 4CZ-366K, 4CZ-366P, 4CZ-366R

Industry
line

DIN
ISO
8976



POUŽITÍ

Instalační SIKO kleště s indukčně kalenými čelistmi (55-58HRC) s vysokou odolností proti opotřebení. Vhodné k použití v domácích dílnách i pro řemeslníky. Tvar drážek čelistí navržen pro pevné sevření kruhových materiálů. Rukojeti tvarované pro ovládání jednou rukou s ohledem na minimální riziko sevření. Přesný spoj zaručuje mimořádně hladký pohyb bez boční vůle.



USABILITY

SIKO plumbing pliers with induction hardened jaws (55-58HRC) with high resistance to wear and tear. Suitable for use in home workshops also for craftsmen. Jaw groove shape designed for tight grip of circular materials. The handles are shaped for one-handed operation with regard to minimal risk of pinching. The precise connection guarantees extremely smooth movement with no side play.



VERWENDUNG

SIKO-Sanitärzange mit induktiv gehärteten Backen (55-58HRC) mit hoher Verschleißfestigkeit. Geeignet für den Einsatz in Bastelwerkstätten aber auch für Handwerker. Die Form der Backenrillen ist für feste Klemmung vom Rundmaterial entworfen. Geformte Griffe für einhändige Bedienung mit Rücksicht auf minimales Risiko des Einklemmens. Präzise Nietverbindung garantiert eine extrem leichte Bewegung ohne Seitenspiel.

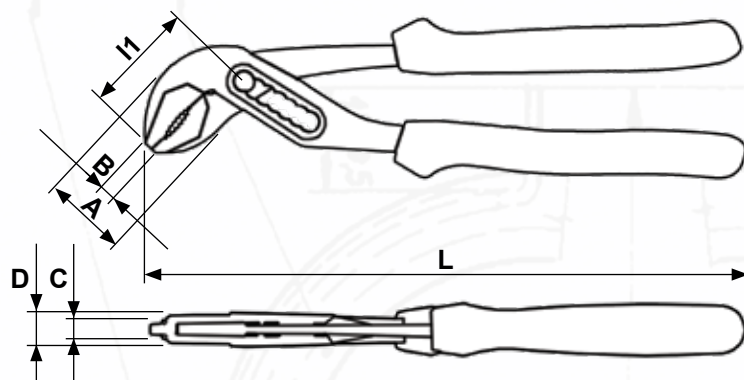

R - rozevření čelistí / opening of the jaws / Backenweite
S - počet poloh nastavení rozevření / the number of opening positions / Anzahl der Einstellpositionen der Backenweite

Kleště SIKO přestavitelné DIN ISO 8976
Adjustment water pump pliers DIN ISO 8976
Wasserpumpenzange DIN ISO 8976

kód/Code Bestellnummer	L (mm)	I1 (mm)	R (mm)	S	A (mm)	B (mm)	C (mm)	D (mm)	W (g)			DPC/RRP (Kč/czk)	DPC/RRP (EUR)	EAN13
4CZ-366-250PVC	243	47,0	4-42	7	33,0	8,0	13,3	8,0	378		5	702,48	29,27	8592667164437

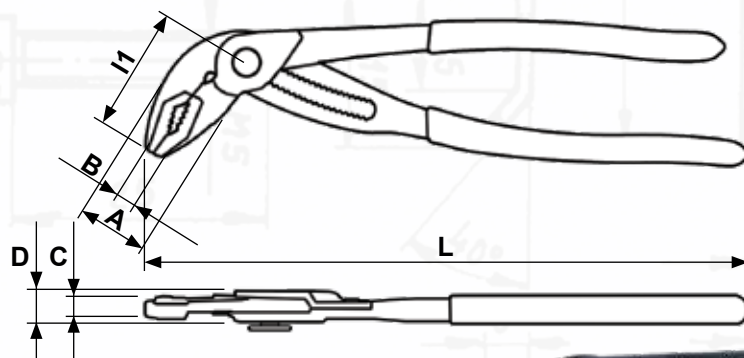

Kleště SIKO rychlořestavitelné DIN ISO 8976
Rapid adjustment water pump pliers sDIN ISO 8976
Wasserpumpenzange „SpeedGrip“ DIN ISO 8976

kód/Code Bestellnummer	L (mm)	I1 (mm)	R (mm)	S	A (mm)	B (mm)	C (mm)	D (mm)	W (g)		DPC/RRP (Kč/czk)	DPC/RRP (EUR)	EAN13
4CZ-366K-180PH	185	39,5	4-42	16	20,0	7,0	14,4	9,2	167	10	531,40	22,14	8592667164444
4CZ-366K-250PH	244	46,5	5-50	16	31,0	8,0	16,5	9,2	332	10	592,56	24,69	8592667164451
4CZ-366K-300PH	303	60,5	7-80	16	35,0	9,0	17,3	9,5	450	6	679,34	28,31	8592667164468

R - rozevření čelistí / opening of the jaws / Backenweite
S - počet poloh nastavení rozevření / the number of opening positions / Anzahl der Einstellpositionen der Backenweite



R - rozevření čelistí / opening of the jaws / Backenweite
 S - počet poloh nastavení rozevření / the number of opening positions / Anzahl der Einstellpositionen der Backenweite

Kleště SIKO rychlořestavitelné DIN ISO 8976
 Rapid adjustment water pump pliers DIN ISO 8976
 Wasserpumpenzange „SpeedGrip“ DIN ISO 8976

kód/Code Bestellnummer	L (mm)	I1 (mm)	R (mm)	S	A (mm)	B (mm)	C (mm)	D (mm)	W (g)	DPC/RRP (Kč/czsk)	DPC/RRP (EUR)	EAN13	
4CZ-366P-250PH	242	47	6-55	9	32	7	8	16,6	345	1	736,00	30,67	8592667206021



R - rozevření čelistí / opening of the jaws / Backenweite
 S - počet poloh nastavení rozevření / the number of opening positions / Anzahl der Einstellpositionen der Backenweite

Kleště SIKO rychlořestavitelné - rovnoběžné DIN ISO 8976
 Rapid adjustment jaws pump pliers - parallel jaws DIN ISO 8976
 Wasserpumpenzange „SpeedGrip“ - parallele Backen DIN ISO 8976

kód/Code Bestellnummer	L (mm)	I1 (mm)	R (mm)	S	A (mm)	B (mm)	C (mm)	D (mm)	W (g)	DPC/RRP (Kč/czsk)	DPC/RRP (EUR)	EAN13	
4CZ-366R-250PH	258	59	0-46	20	29	1	8,2	20	430	1	1069,00	44,54	8592667206045



Kód / Code / Bestellnummer
4CZ-319, 4CZ-321

Industry
line

DIN
ISO
5745



POUŽITÍ

Kleště s kulatými nebo plochými čelistmi pro ohýbání, kroucení nebo tvarování měkkého drátu. Čelisti kleští jsou vroubkované pro bezpečné protiskluzové uchopení materiálu. Přesný nýtovaný spoj zaručuje mimořádně hladký pohyb bez boční vůle.



USABILITY

Pliers with round or flat jaws for bending, twisting or shaping of soft wire. The jaws of the pliers are serrated for a secure non-slip grip of the material. The jaws of the pliers are serrated for a secure non-slip gripping of the material. The precise riveted joint guarantees extraordinary smooth movement without side play.



VERWENDUNG

Zange mit runden oder flachen Backen zum Biegen, Verdrehen oder Formen vom weichen Draht. Die Zangenbacken sind gerändelt, um eine sichere, rutschfeste Ergreifung des Materials zu sichern. Präzise Nietverbindung garantiert eine extrem leichte Bewegung ohne Seitenspiel.

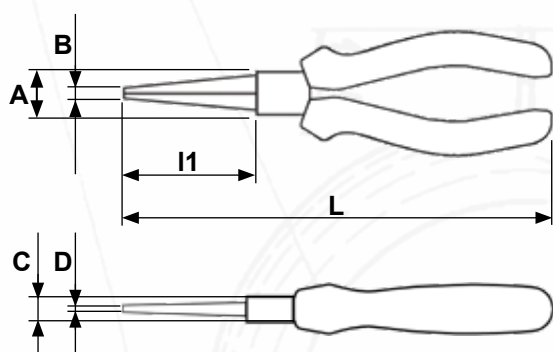

Kleště na drát s kulatými čelistmi DIN ISO 5745
Round nose pliers DIN ISO 5745
Verdrahtungszange mit runden Backen DIN ISO 5745

kód/Code Bestellnummer	L (mm)	I1 (mm)	A (mm)	B (mm)	C (mm)	D (mm)	W (g)	DPC/RRP (Kč/czk)	DPC/RRP (EUR)	EAN13	
4CZ-319-160PVC	174	60,0	18,3	5,2	9,4	2,6	161	10	456,20	19,01	8592667164314

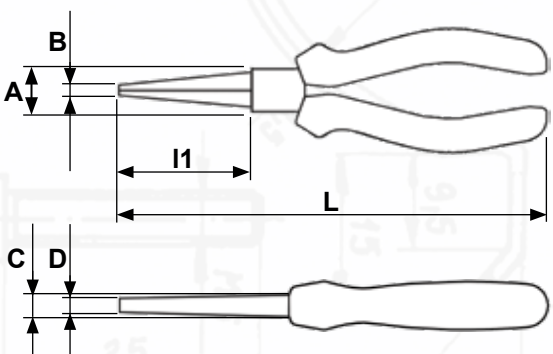

Kleště na drát s plochými čelistmi DIN ISO 5745
Flat nose pliers DIN ISO 5745
Verdrahtungszange mit flachen Backen DIN ISO 5745

kód/Code Bestellnummer	L (mm)	I1 (mm)	A (mm)	B (mm)	C (mm)	D (mm)	W (g)	DPC/RRP (Kč/czk)	DPC/RRP (EUR)	EAN13	
4CZ-321-160PVC	174	60,0	18,3	3,2	9,4	8,8	182	12	415,70	17,32	8592667164338





Kód / Code / Bestellnummer
4CZ-2305, 4CZ-2306

Industry
line

Cr-Mo

DIN
ISO
5745



POUŽITÍ

Kleště z chrom-molybdenové oceli, kované a kalené do oleje. Štípací břity pro drát jsou dodatečně indukčně kalené a zajišťují čistý řez pro drát měkkký i s vysokou pevností v tahu. Vysokopevnostní čelisti poskytují pevné uchopení. Vhodné k použití v domácích dílnách i pro řemeslníky pro práci s plochým i kruhovým materiálem. Přesný nýtovaný spoj zaručuje mimořádně hladký pohyb bez boční vůle. Nejvýhodnější poměr hmotnosti a pevnosti.



USABILITY

Pliers made of chrome-molybdenum steel, forged and oil-hardened. Splitting blades for wire are induction hardened additionally and ensure a clean cut either for soft wire or for wire with high tensile strength. High solid jaws provide a firm grip. Suitable for use in home workshops and for craftsmen for work with both flat and round material. The precise riveted joint guarantees extraordinary smooth movement without side play. Best weight and strength ratio.



VERWENDUNG

Zange aus Chrom-Molybdän-Stahl, geschmiedet und ölgehärtet. Die Schneiden für Draht sind zusätzlich induktiv gehärtet und gewährleisten einen präzisen Schnitt sowohl für weiche Drähte als auch für Drähte mit hoher Zugfestigkeit. Hochfeste Backen bieten eine feste Ergreifung. Geeignet für den Einsatz in Bastelwerkstätten aber auch für Handwerker zur Bearbeitung vom Flach- und Rundmaterial. Präzise Nietverbindung garantiert eine extrem leichte Bewegung ohne Seitenspiel. Das vorteilhafteste Gewichts- und Festigkeitsverhältnis.

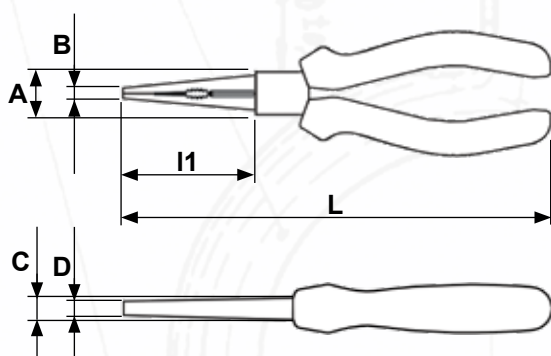

M - střední drát / medium wire / mittlerer Draht
H - tvrdý drát / hard wire / harter Draht

Kleště pro jemnou mechaniku DIN ISO 5745
Long nose pliers DIN ISO 5745
Zangen für die Feinmechanik DIN ISO 5745

kód/Code Bestellnummer	L (mm)	I1 (mm)	A (mm)	B (mm)	C (mm)	D (mm)	M (mm)	H (mm)	W (g)	GS	GS	DPC/RRP (Kč/czk)	DPC/RRP (EUR)	EAN13
4CZ-2305-160PVC	172	58,0	18,0	3,2	8,9	2,3	2,5	1,6	164	●	10	458,68	19,11	8592667163935
4CZ-2305-200PVC	217	83,5	22,0	4,6	10,9	3,6	3,2	2,2	254	●	10	578,51	24,10	8592667163942

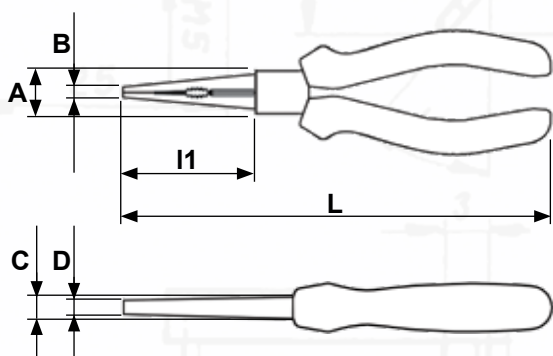

M - střední drát / medium wire / mittlerer Draht
H - tvrdý drát / hard wire / harter Draht

Kleště pro jemnou mechaniku zahnuté DIN ISO 5745
Bent nose pliers DIN ISO 5745
Zangen für die Feinmechanik gebogen DIN ISO 5745

kód/Code Bestellnummer	L (mm)	I1 (mm)	A (mm)	B (mm)	C (mm)	D (mm)	M (mm)	H (mm)	W (g)	GS	GS	DPC/RRP (Kč/czk)	DPC/RRP (EUR)	EAN13
4CZ-2306-160PVC	166	52,0	17,8	3,5	9,2	2,4	2,5	1,6	164	●	10	500,83	20,87	8592667163966
4CZ-2306-200PVC	208	75,0	22,0	3,9	11,0	3,1	3,2	2,2	260	●	10	602,48	25,10	8592667163973





Kód / Code / Bestellnummer

4CZ-2300

Industry
line

DIN
ISO
8979



POUŽITÍ

Odizolovací kleště pro stříhání a odstraňování izolace na kabely s průřezem do 10 mm². Seřizovací prvek pro jednoduché a plynulé nastavení otevření čelistí. Přídržovací pružina pro efektivnější práci. Maximální kapacita vodiče 6 mm (3A WG).



USABILITY

Stripping pliers for cutting and removing insulation for cables with a cross-section of up to 10 mm². Adjustable element for simple and smooth opening adjustment jaws. Holding spring for more efficient work. Maximum wire capacity 6mm (3A WG).



VERWENDUNG

Abisolierzange zum Schneiden und Abisolieren von Kabeln bis 10 mm². Einstellelement für einfache und stufenlose Einstellung der Backenöffnung. Eine Haltefeder für leistungsfähigeres Arbeiten. Die maximale Leiterkapazität 6 mm (3A WG).

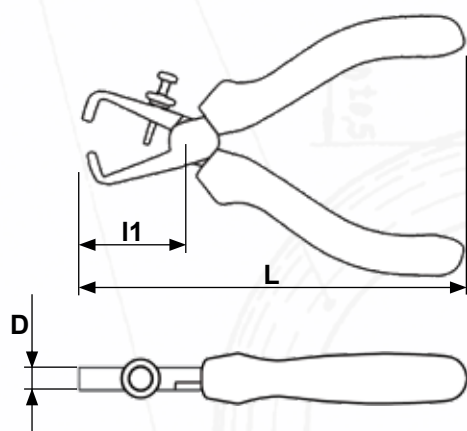

Kleště odizolovávající DIN ISO 8979
Wire stripping pliers DIN ISO 8979
Abisolierzangen DIN ISO 8979

R - průřez vodiče mm² / conductor cross-section mm² / R - Leiterquerschnitt mm²

kód/Code Bestellnummer	L (mm)	l1 (mm)	D (mm)	R (mm ²)	W (g)			DPC/RRP (Kč/czk)	DPC/RRP (EUR)	EAN13
4CZ-2300-160PVC	160	43,0	8,5	10,0	164	•	10	504,96	21,04	8592667163928





Kód / Code / Bestellnummer

4CZ-2325, 4CZ-2326, 4CZ-2327, 4CZ-2328

Industry
line

DIN
ISO
5254

DIN
ISO
5256



POUŽITÍ

Kleště na pojistné kroužky (segerovky) z chrom-molybdenové oceli, kované a kalené do oleje. Vhodné k použití v průmyslu i pro řemeslníky a domácí dílny. Přesně opracované a pečlivě ošetřené hroty odolné proti deformacím. Protiskluzová úprava a úhel hrotu umožňuje kroužku pevně přilnout k hrotům při stlačování nebo roztahování. Přesný nýtovaný spoj zaručuje mimořádně hladký pohyb bez boční vůle.



USABILITY

Circlip pliers ("Seeger") made of chrome-molybdenum steel, forged and oil-hardened. Suitable for use in industry and for craftsmen and home workshops. Precisely machined and carefully treated deformation-resistant tips. Anti-slip treatment and angle of the tip allow the ring to be tightly stuck to the tips when compressed or stretched. The precise riveted joint guarantees extraordinary smooth movement without side play.



VERWENDUNG

Sicherungsringzange (Seegerringzange) aus Chrom-Molybdän-Stahl, geschmiedet und ölgehärtet. Geeignet für den Einsatz in der Industrie aber auch für Handwerker und in Bastelwerkstätten. Präzise bearbeitete und sorgfältig behandelte verformungsbeständige Spitzen. Anti-Rutsch-Behandlung und der Winkel der Spitze ermöglichen dem Ring beim Zusammendrücken und Strecken den Spitzen fest anzuhafte. Präzise Nietverbindung garantiert eine extrem leichte Bewegung ohne Seitenspiel.

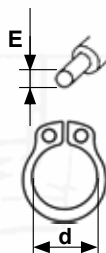
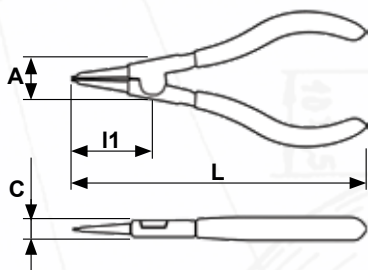

Kleště na pojistné kroužky pro hřídele rovné DIN ISO 5254
Pliers for external circlips straight DIN ISO 5254
Sicherungsringzange für Wellen gerade DIN ISO 5254

kód/Code Bestellnummer	L (mm)	I1 (mm)	A (mm)	C (mm)	E (mm)	d (mm)	typ	W (g)	DPC/RRP (Kč/czk)	DPC/RRP (EUR)	EAN13	
4CZ-2325-140MPH	134	38,0	23,3	8,1	0,9	3-10	⊙⊙	99	6	409,09	17,05	8592667164031
4CZ-2325-140PH	133	38,0	23,3	8,4	1,3	10-25	⊙⊙	97	6	370,25	15,43	8592667164048
4CZ-2325-180PH	168	52,0	27,0	9,4	1,8	19-60	⊙⊙	150	10	423,14	17,63	8592667164055
4CZ-2325-230PH	229	65,0	33,8	11,2	2,3	40-100	⊙⊙	318	10	653,72	27,24	8592667164062

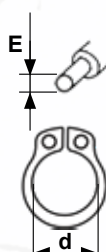
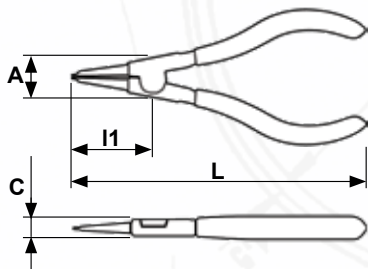

Kleště na pojistné kroužky pro hřídele vyhnuté 90° DIN ISO 5254
Pliers for external circlips bent 90° DIN ISO 5254
Sicherungsringzange für Wellen gekröpft 90° DIN ISO 5254

kód/Code Bestellnummer	L (mm)	I1 (mm)	A (mm)	C (mm)	E (mm)	d (mm)	typ	W (g)	DPC/RRP (Kč/czk)	DPC/RRP (EUR)	EAN13	
4CZ-2326-130MPH	127	31,0	22,0	8,2	0,9	3-10	⊙⊙	97	6	409,09	17,05	8592667164079
4CZ-2326-140PH	127	31,0	23,0	8,5	1,3	10-25	⊙⊙	98	6	370,25	15,43	8592667164086
4CZ-2326-180PH	162	39,0	26,5	9,3	1,8	19-60	⊙⊙	149	10	423,14	17,63	8592667164093
4CZ-2326-230PH	223	51,0	34,0	10,9	2,3	40-100	⊙⊙	315	10	653,72	27,24	8592667164109

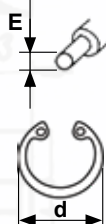
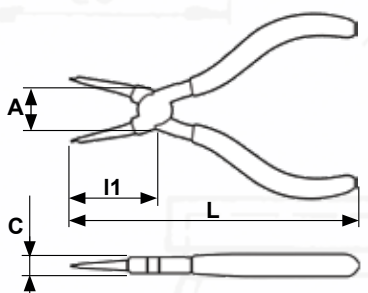

Kleště na pojistné kroužky pro otvory rovné DIN ISO 5256
Pliers for internal circlips straight DIN ISO 5256
Sicherungsringzange für Löcher gerade DIN ISO 5256

kód/Code Bestellnummer	L (mm)	I1 (mm)	A (mm)	C (mm)	E (mm)	d (mm)	typ	W (g)	DPC/RRP (Kč/czk)	DPC/RRP (EUR)	EAN13	
4CZ-2327-140MPH	133	39,0	15,4	8,5	0,9	8-13	⊙⊙	93	6	409,09	17,05	8592667164116
4CZ-2327-140PH	133	39,0	15,1	8,5	1,3	12-25	⊙⊙	90	6	370,25	15,43	8592667164123
4CZ-2327-180PH	173	50,0	17,8	9,3	1,8	19-60	⊙⊙	143	10	423,14	17,63	8592667164130
4CZ-2327-230PH	239	64,0	23,5	11,0	2,3	40-100	⊙⊙	333	10	653,72	27,24	8592667164147

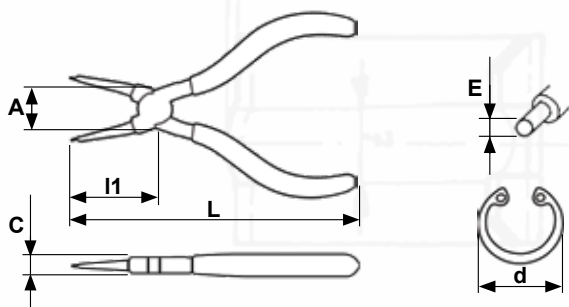

Kleště na pojistné kroužky pro otvory vyhnuté 90° DIN ISO 5256
Pliers for internal circlips bent 90° DIN ISO 5256
Sicherungsringzange für Löcher gekröpft 90° DIN ISO 5256

kód/Code Bestellnummer	L (mm)	l1 (mm)	A (mm)	C (mm)	E (mm)	d (mm)	typ	W (g)		DPC/RRP (Kč/czk)	DPC/RRP (EUR)	EAN13
4CZ-2328-130MPH	126	31,0	15,2	8,5	0,9	8-13	⊙⊙	91	6	409,09	17,05	8592667164154
4CZ-2328-130PH	126	31,0	15,2	8,3	1,3	12-25	⊙⊙	92	6	370,25	15,43	8592667164161
4CZ-2328-180PH	159	39,0	17,7	9,4	1,8	19-60	⊙⊙	148	10	423,14	17,63	8592667164178
4CZ-2328-230PH	227	50,0	23,0	11,0	2,3	40-100	⊙⊙	327	10	653,72	27,24	8592667164185



Kód / Code / Bestellnummer

4CZ-35xM, 4CZ-230xM

Industry
line



POUŽITÍ

Kleště s precizním provedením pro přesné montážní práce, elektroniku, jemnou mechaniku, zpracování šperků apod. Štipací břity vhodné pro dělení jemného měkkého měděného drátu do průměru 1,5 mm. Dvoulistá pružina pro snadné ovládání. Přesný nýtovaný spoj zaručuje mimořádně hladký pohyb bez boční vůle.



USABILITY

Pliers with a precise design for precise assembly work, electronics, fine mechanics, processing jewelry, etc. Blades suitable for splitting fine soft copper wire up to diameter 1.5 mm. Double leaf spring for easy control. The precise riveted joint guarantees extraordinary smooth movement without side play.



VERWENDUNG

Zange mit präziser Ausführung für genaue Montagearbeiten, Elektronik, Feinmechanik, Schmuckherstellung u. ä. Die Schneiden sind für Schneiden vom feinen weichen Kupferdraht bis 1,5 mm geeignet. Doppelfeder für einfache Handhabung. Präzise Nietverbindung garantiert eine extrem leichte Bewegung ohne Seitenspiel.

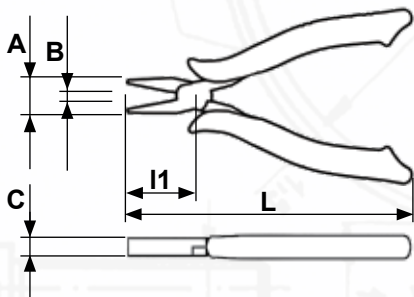

Kleště kombinované pro jemnou mechaniku
Combination pliers for fine mechanics
Kombizange für Feinmechanik

kód/Code Bestellnummer	L (mm)	l1 (mm)	A (mm)	B (mm)	C (mm)	W (g)		DPC/RRP (Kč/czk)	DPC/RRP (EUR)	EAN13
4CZ-351M-125PVC	132	30,0	12,5	3,8	7,9	87	10	433,06	18,04	8592667164420

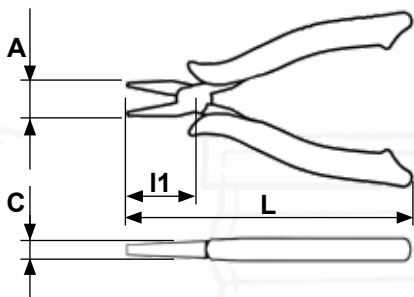

Kleště štipací boční pro jemnou mechaniku
Diagonal cutting pliers for fine mechanics
Seitenschnneider für die Feinmechanik

kód/Code Bestellnummer	L (mm)	l1 (mm)	A (mm)	C (mm)	W (g)		DPC/RRP (Kč/czk)	DPC/RRP (EUR)	EAN13
4CZ-355M-125PVC	123,0	22,0	12,4	8,0	90	10	433,06	18,04	8592667164376



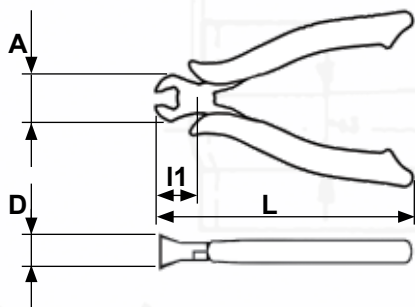

Kleště štípací čelní pro jemnou mechaniku
End cutting pliers for fine mechanics
Kneifzange für die Feinmechanik

kód/Code Bestellnummer	L (mm)	I1 (mm)	A (mm)	D (mm)	W (g)	DPC/RRP (Kč/czk)	DPC/RRP (EUR)	EAN13
4CZ-310M-125PVC	117,0	15,5	15,6	12,9	92	10 433,06	18,04	8592667164291

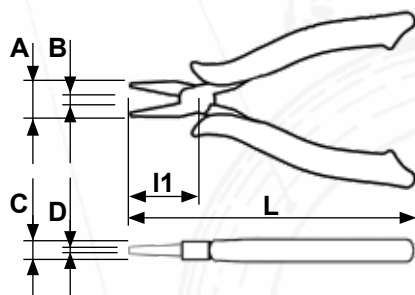

Kleště na drát s kulatými čelistmi pro jemnou mechaniku
Round nose pliers for fine mechanics
Verdrahtungszeuge mit runden Backen für die Feinmechanik

kód/Code Bestellnummer	L (mm)	I1 (mm)	A (mm)	B (mm)	C (mm)	D (mm)	W (g)	DPC/RRP (Kč/czk)	DPC/RRP (EUR)	EAN13
4CZ-319M-125PVC	131,0	31,0	12,3	3,2	7,5	1,6	88	10 419,83	17,49	8592667164321

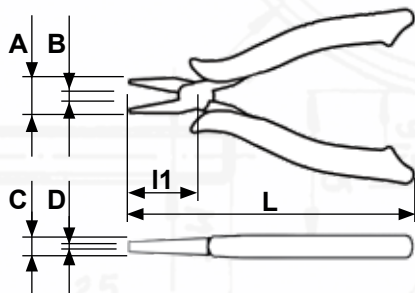

Kleště na drát s plochými čelistmi pro jemnou mechaniku
Flat nose pliers for fine mechanics
Verdrahtungszeuge mit flachen Backen für die Feinmechanik

kód/Code Bestellnummer	L (mm)	I1 (mm)	A (mm)	B (mm)	C (mm)	D (mm)	W (g)	DPC/RRP (Kč/czk)	DPC/RRP (EUR)	EAN13
4CZ-321M-150PVC	152,0	50,0	12,3	2,4	8,0	5,1	101	10 419,83	17,49	8592667164345



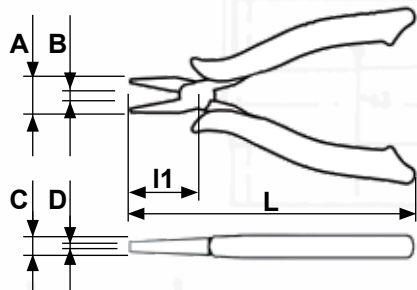

Kleště na drát s půlkulatými čelistmi pro jemnou mechaniku
Long nose pliers for fine mechanics

Verdrahtungszange mit halbrund Backen für die Feinmechanik

kód/Code Bestellnummer	L (mm)	I1 (mm)	A (mm)	B (mm)	C (mm)	D (mm)	W (g)	DPC/RRP (Kč/czk)	DPC/RRP (EUR)	EAN13
4CZ-2305M-150PVC	151,0	49,0	12,7	2,0	7,8	1,8	96	10 433,06	18,04	8592667163959

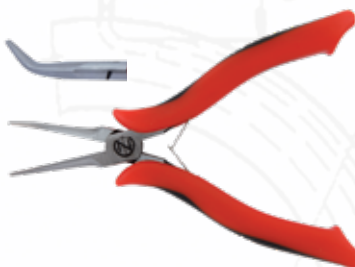
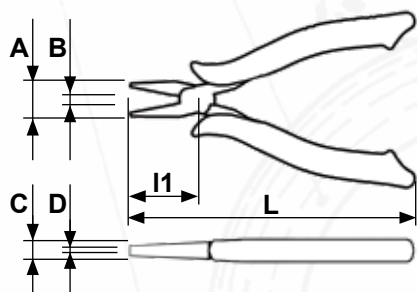

Kleště na drát s půlkulatými zahnutými čelistmi pro jemnou mechaniku
Bent nose pliers for fine mechanics

Verdrahtungszange mit halbrunden gebogenen Backen für die Feinmechanik

kód/Code Bestellnummer	L (mm)	I1 (mm)	A (mm)	B (mm)	C (mm)	D (mm)	W (g)	DPC/RRP (Kč/czk)	DPC/RRP (EUR)	EAN13
4CZ-2306M-150PVC	145,0	45,0	12,5	2,7	7,9	2,0	95	10 419,83	17,49	8592667163980

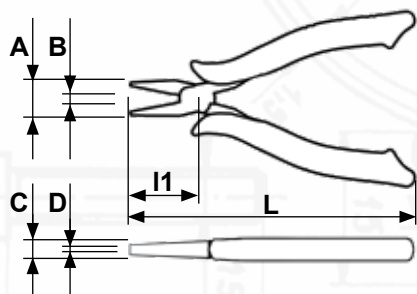

Kleště na drát s půlkulatými jehlovými čelistmi pro jemnou mechaniku
Needle nose pliers for fine mechanics

Verdrahtungszange mit halbrunden gebogenen Backen für die Feinmechanik

kód/Code Bestellnummer	L (mm)	I1 (mm)	A (mm)	B (mm)	C (mm)	D (mm)	W (g)	DPC/RRP (Kč/czk)	DPC/RRP (EUR)	EAN13
4CZ-2307M-150PVC	151,0	50,0	12,4	1,8	7,8	2,0	95	10 419,83	17,49	8592667163997



Kód / Code / Bestellnummer
4CZ-270, 4CZ-270NN

Industry
line

Cr-Mo



POUŽITÍ

Kleště pro precizní stříhání kari sítí, svorníků, tyčí a mnoha dalších tvarů ze železa. Řezné nože ze zápusťkově kované Cr-Mo oceli. Silné a odolné provedení pro snadné ovládání a tvarovaná rukojeť pro větší pohodlí. Nože náhradní ke kleštím na tyče a svorníky.



USABILITY

Pliers for precise cutting of reinforcement mesh, studs, rods and many other iron-made shapes. Cutting knives made of die-forged Cr-Mo steel. Strong and durable design for easy operation and convenience-shaped handle.



VERWENDUNG

Zange zum präzisen Schneiden von Drahtgittern, Bolzen und Stangen und vielen anderen Eisenformen. Das Schneidmesser aus gesenkgeschmiedetem Cr-Mo-Stahl. Feste und widerstandsfähige Ausführung für einfache Handhabung und geformter Handgriff für mehr Komfort. Ersatzmesser für Stangen und Bolzen.

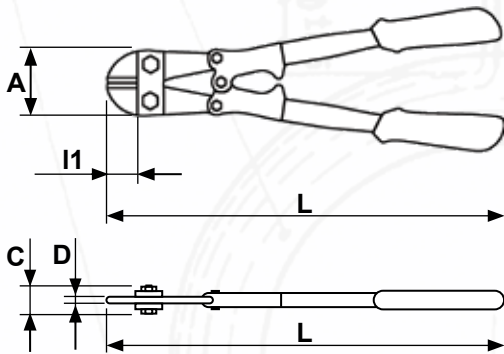

20HRC - měkký drát / soft wire / weicher Draht
40HRC - střední drát / medium wire / mittlerer Draht

Kleště štípací na tyče a svorníky
Bolt cutters
Bolzenschneider

kód/Code Bestellnummer	L (mm)	I1 (mm)	A (mm)	C (mm)	D (mm)	20HRC	40HRC (mm)	W (g)		DPC/RRP (Kč/czk)	DPC/RRP (EUR)	EAN13
4CZ-270-370	366	27,0	60,0	33,0	6,8	7,0	4,0	1023	1	1115,70	46,49	8592667164192
4CZ-270-480	465	32,0	70,0	37,0	7,8	8,0	5,0	1619	1	1342,15	55,92	8592667164208
4CZ-270-630	632	37,0	82,0	43,0	9,8	10,0	6,0	2625	1	1840,50	76,69	8592667164215
4CZ-270-780	788	39,0	96,0	48,0	10,9	13,0	7,0	4207	1	2564,46	106,85	8592667164222
4CZ-270-930	939	39,0	109,0	53,0	13,0	16,0	8,0	6026	1	3199,17	133,30	8592667164239

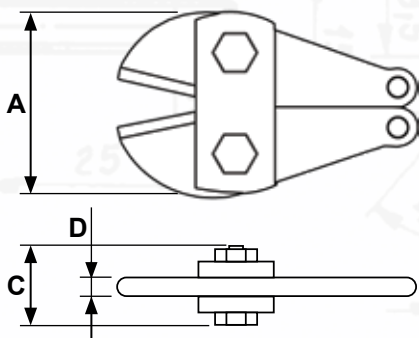

Náhradní nože pro kleště 270
Spare blades for bolt cutters.
Ersatzklingen für Bolzenschneider

20HRC - měkký drát / soft wire / weicher Draht
40HRC - střední drát / medium wire / mittlerer Draht

kód/Code Bestellnummer	A (mm)	C (mm)	D (mm)	20HRC	40HRC (mm)	W (g)		DPC/RRP (Kč/czk)	DPC/RRP (EUR)	EAN13
4CZ-270NN-370	60,0	33,0	6,8	7,0	4,0	345	1	737,19	30,72	8592667200555
4CZ-270NN-480	70,0	37,0	7,8	8,0	5,0	579	1	886,78	36,95	8592667200562
4CZ-270NN-630	82,0	43,0	9,8	10,0	6,0	927	1	1217,36	50,72	8592667200579
4CZ-270NN-780	96,0	48,0	10,9	13,0	7,0	1406	1	1701,65	70,90	8592667200586
4CZ-270NN-930	109,0	53,0	13,0	16,0	8,0	1985	1	2129,75	88,74	8592667200593



Kód / Code / Bestellnummer

4CZ-HS

Industry
line

CrV



POUŽITÍ

Jednoruční instalatérský hasák s pohyblivou upínací čelistí. Přímé a rychlé nastavování pomocí čelisti s hákem, uložené na pružinách. Rukojeti z robustní tvárné litiny, červený lak. Ostré, čisté zpracované ozubené čelisti. Výhody: Skutečná obsluha jednou rukou, plynulá práce s ráčnou, rychlé a bezpečné uchopení. Použití: Čelisti tlačí při utahování pevně na trubku a uvolní se automaticky při nadzvednutí rukojeti.



USABILITY

Pipe wrench with movable jaw. Direct and quick positioning using the spring-loaded hook jaw. Handle of sturdy malleable cast iron, red paint finish. Sharp and cleanly finished gripper jaws. Advantages: Genuine one-handed operation, smooth ratchet action, quick and secure grip. Application: When tightening, the jaws press tightly on the pipe, and then release automatically when the handle is lifted.



VERWENDUNG

Einhand-Rohrzange mit beweglicher Spannbacke. Direktes und schnelles Einstellen anhand der federbelasteten Hackenbacke. Griffe aus robustem Kugelgraphitguss, rot lackiert. Scharfe, sauber gearbeitete Greifbacken. Vorteile: Echte Einhandbedienung, zügiges, ratschendes Arbeiten, schneller und sicherer Halt. Verwendung: Beim Anziehen pressen sich die Backen fest an das Rohr und lösen sich automatisch beim Anheben des Griffes.

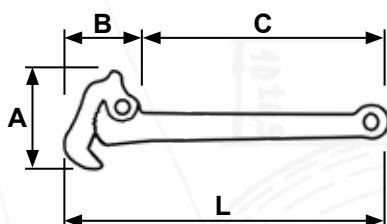

Hasák Cr-V čelist, litinová rukojet'

Pipe wrench with Cr-V jaw, cast iron handle

Einhand-Rohrzange mit Cr-V Spannbacke, Gusseisen Griff

kód/Code Bestellnummer	L (inch)	L (mm)	A (mm)	B (mm)	C (mm)	rozsah/range Breite (mm)	W (g)		DPC/RRP (Kč/czk)	DPC/RRP (EUR)	EAN13
4CZ-HS-200	8"	210	71	56	155	10-27	350	1	855,37	35,64	8592667146105
4CZ-HS-350	14"	350	103	82	265	19-42	880	1	1294,21	53,93	8592667146112

Kód / Code / Bestellnummer

4CZ-OIL-10

Industry
line

CrV



POUŽITÍ

Profesionální kleště na demontáž, montáž průtokových, olejových a palivových filtrů. Možnost nastavení rozevření čelistí dle průměru filtrů. Speciální ozubení obou čelistí a ergonomické rukojeti potažené plastem. Vhodné na rozměry od 2-1/2" do 4-5/8" (63,5 mm – 116 mm). Vyrobeno z jakostní Chrom-Vanadiové oceli. Kleště jsou určeny do autoopravárenství, ale své uplatnění naleznou i v hobby dílnách.



USABILITY

Professional pliers for dismantling, assembling of flow, oil and fuel filters. Possibility of setting jaws opening according to filter's diameter. Special toothed jaws and ergonomic handle coated with plastic. Suitable for diameters from 2-1/2" to 4-5/8" (63,5 mm – 116 mm). Made of high quality chromium-vanadium steel. Pliers can be used in car repairing but they can also be used in hobby workshops.



VERWENDUNG

Professionelle Zange für den Ausbau und die Montage von Durchlauf-, Öl- und Treibstofffiltern. Möglichkeit der Einstellung der Backenöffnung je nach Filterdurchmesser. Spezielle Zahnung beider Backen und ergonomische Griffe mit Kunststoffüberzug. Geeignet für Durchmesser von 2-1/2" bis 4-5/8" (63,5 mm – 116 mm). Aus hochwertigem Chrom-Vanadium-Stahl gefertigt. Die Zange ist für Autowerkstätten vorgesehen, finden aber auch in Hobbywerkstätten Anwendung.

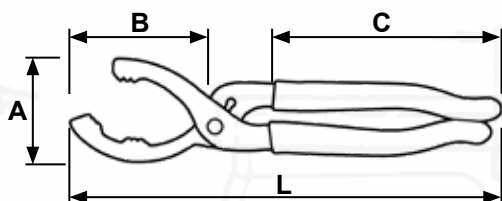

Kleště na olejové filtry průměru 63,5 - 116 mm

Oil filter pliers for diameter 63,5 - 116 mm

Ölfilterzange Ø 63,5 bis 116 mm

kód/Code Bestellnummer	L (mm)	A (mm)	B (mm)	C (mm)	W (g)		DPC/RRP (Kč/czk)	DPC/RRP (EUR)	EAN13
4CZ-OIL-10	300	70	95	160	493	6	390,91	16,29	8592667146044



Kód / Code / Bestellnummer
4CZ-803, 4CZ-804

Industry
line

CrMoV



HRC
58 / 54

1000V



POUŽITÍ

Určeno pro práci pod napětím v elektrotechnických oborech. Je zaručena bezpečná práce až do napětí 1000V. Dřík šroubováku z chrom-molybden-vanadiové oceli s černěným antikoročním povrchem a izolačním obštríkem. Ergonomická měkká proti-skluzová rukojeť pro větší kroutící moment při nižší námaze, odolná proti nárazům. Tvar brání samovolnému pohybu při odložení. Dodáváno s praktickým plastovým držákem.



USABILITY

Intended for work under voltage in electrical engineering fields. Safe operation is guaranteed up to a voltage of 1000V. The screwdriver's shank made of chrome-molybdenum-vanadium steel with blackened anti-corrosion surface and insulating coating. Ergonomic soft anti-slip handle for greater torque with less effort, impact resistant. The shape prevents spontaneous movement when put away. Supplied with a practical plastic holder.



VERWENDUNG

Entwickelt für Arbeiten unter Spannung in der Elektroindustrie. Sicheres Arbeiten bis zu 1000 V ist garantiert. Schraubenschaft aus Chrom-Molybdän-Vanadium-Stahl mit geschwärtzter Anti-Korrosions-Oberfläche und Isolierspray. Ergonomischer, weicher, rutschfester Griff für mehr Drehmoment bei geringerem Kraftaufwand, schlagfest. Die Form verhindert eine spontane Bewegung beim Absetzen. Wird mit praktischem Kunststoffhalter geliefert.



Šroubovák 1000V PL ELEKTRO
Insulated screwdriver 1000V ELEKTRO
Schraubendreher 1000V Schlitz ELEKTRO

kód/Code Bestellnummer	S	B (mm)	d (mm)	I (mm)	L (mm)	H (mm)	D (mm)	W (g)		DPC/RRP (Kč/czk)	DPC/RRP (EUR)	EAN13
4CZ-8038-02	SL3	0,5	3	100	198	98	28	53	12	96,69	4,03	8592667193581
4CZ-8038-04	SL3,5	0,6	3	100	198	98	28	53	12	96,69	4,03	8592667193598
4CZ-8038-05	SL4	0,8	3	100	198	98	28	53	12	96,69	4,03	8592667193604
4CZ-8038-06	SL5,5	1	5	125	238	110	31	85	12	112,40	4,68	8592667193611
4CZ-8038-07	SL6,5	1,2	6	150	268	115	31	123	12	141,32	5,89	8592667193628
4CZ-8038-08	SL8	1,2	8	175	300	125	36	191	12	176,03	7,33	8592667193635
4CZ-8038-10	SL10	1,6	8	200	328	125	36	204	12	181,82	7,58	8592667193642

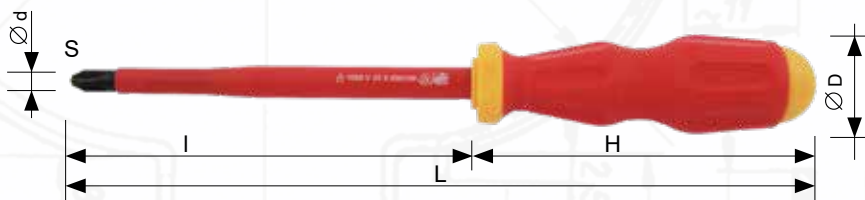

Šroubovák 1000V PH ELEKTRO
Insulated Screwdriver 1000V PH ELEKTRO
Schraubendreher 1000V ELEKTRO

kód/Code Bestellnummer	S	d (mm)	I (mm)	L (mm)	H (mm)	D (mm)	W (g)		DPC/RRP (Kč/czk)	DPC/RRP (EUR)	EAN13
4CZ-8039-00	PH0	3	60	160	98	28	49	12	95,04	3,96	8592667193659
4CZ-8039-01	PH1	4,5	80	195	110	31	78	12	109,09	4,55	8592667193666
4CZ-8039-02	PH2	6	100	218	115	33	110	12	137,19	5,72	8592667193673
4CZ-8039-03	PH3	8	150	275	125	36	183	12	171,07	7,13	8592667193680



Šroubovák 1000V PZ ELEKTRO
Insulated Screwdriver 1000V PZ ELEKTRO
Schraubendreher 1000V ELEKTRO

kód/Code Bestellnummer	S	d (mm)	I (mm)	L (mm)	H (mm)	D (mm)	W (g)		DPC/RRP (Kč/czk)	DPC/RRP (EUR)	EAN13
4CZ-8040-01	PZ1	4,5	80	195	110	31	78	12	111,57	4,65	8592667193697
4CZ-8040-02	PZ2	6	100	218	115	33	110	12	140,50	5,85	8592667193703
4CZ-8040-03	PZ3	8	150	275	125	36	182	12	173,55	7,23	8592667193710





Sada šroubováků 1000V PL,PH 6 dílná ELEKTRO
Insulated screwdriver set 1000V SL,PH 6 pcs
Schraubendrehersatz 1000V SL,PH 6-teilig ELEKTRO

kód/Code Bestellnummer	W (g)	DPC/RRP (Kč/czk)	DPC/RRP (EUR)	EAN13
4CZ-7556-50	1	566,94	23,62	8592667199965

obsah / content / Inhalt	velikost / size / Größe
Šroubovák elektrikařský plochý profil Insulated screwdriver straight tip profi Elektriker-Schraubendreher platt profi	PL 0,5; PL 0,8; PL 1,0; PL 1,2
Šroubovák elektrikařský phillips profil Insulated screwdriver phillips tip profi Elektriker-Schraubendreher phillips profi	PH1; PH2

Sada šroubováků 1000V PL,PH 6 dílná ELEKTRO + zkoušečka, v kufru
Insulated screwdriver set 1000V SL,PH 6 pcs + tester, in a box
Schraubendrehersatz 1000V SL,PH 6-teilig ELEKTRO + Spannungsprüfer, im Koffer

kód/Code Bestellnummer	W (g)	DPC/RRP (Kč/czk)	DPC/RRP (EUR)	EAN13
4CZ-7556-60	1	840,50	35,02	8592667199972

obsah / content / Inhalt	velikost / size / Größe
Šroubovák elektrikařský plochý profil Insulated screwdriver straight tip profi Elektriker-Schraubendreher platt profi	PL 0,5; PL 0,8; PL 1,0; PL 1,2
Šroubovák elektrikařský phillips profil Insulated screwdriver phillips tip profi Elektriker-Schraubendreher phillips profi	PH1; PH2
Jednopolová zkoušečka napětí 230V Single-pole voltage tester 230V Einpoliger Spannungsprüfer 230V	



Kód / Code / Bestellnummer

4CZ-833

Industry
line

CrMo



HRC
58 / 54

1000V



POUŽITÍ

Určeno pro práci pod napětím v elektrotechnických oborech. Je zaručena bezpečná práce až do napětí 1000V. Dřík šroubováku ze zúšlechťené vysoce legované oceli s černým povrchem a izolačním obštrikem. Ergonomická dvouplastová rukojeť s otvorem pro zavěšení. Tvar brání samovolnému pohybu při odložení. Dodáváno s praktickým plastovým držákem.



USABILITY

Screwdriver suitable for work under tension in electrotechnical fields. Safe working up to 1000V is guaranteed. Blade of a screwdriver from treated highly alloyed steel with black surface and insulated coating. Ergonomic twin plastic handle with opening for hanging. The form protects from spontaneous movement when put away. Supplied with practical plastic holder.



VERWENDUNG

Unter Spannung in elektrischen Feldern Entwickelt für die Arbeit. Es wird garantiert ein sicheres Arbeiten bis 1000V. Der Schaft Schraubendreher gehärtetem Stahl mit einer geschwärzten Oberfläche und Isolierung Injektionen. Doppel-beschichteten ergonomischer Handgriff mit Loch zum Aufhängen. Die Form verhindert das versehentliche Bewegung während der Verschiebung. Ausgestattet mit einem handlichen Kunststoffhalter.

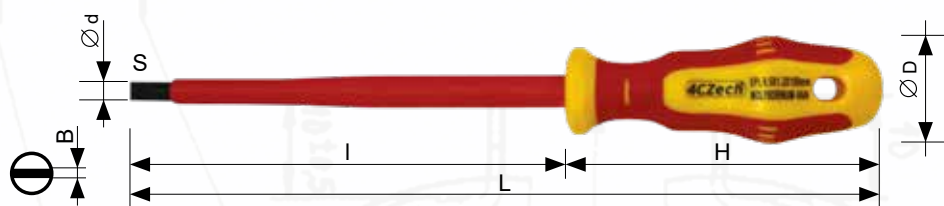

Šroubovák elektrikařský plochý profil 1000V
Insulated screwdriver straight tip profil 1000V
Elektriker-Schraubendreher Schlitz profil 1000V

kód/Code Bestellnummer	S	B (mm)	d (mm)	I (mm)	L (mm)	H (mm)	D (mm)	W (g)		DPC/RRP (Kč/czk)	DPC/RRP (EUR)	EAN13
4CZ-8330-01	SL2,5	0,4	2,5	80	160	80	27	28	12	88,43	3,68	8592667036147
4CZ-8330-03	SL3	0,5	3	100	180	80	27	31	12	119,01	4,96	8592667036154
4CZ-8330-04	SL3,5	0,6	3,5	100	180	80	27	36	12	133,06	5,54	8592667036161
4CZ-8330-05	SL4	0,8	4	100	195	95	32	53	12	149,59	6,23	8592667036178
4CZ-8330-06	SL5,5	1	5,5	125	220	95	32	71	12	163,64	6,82	8592667036185
4CZ-8330-07	SL6,5	1,2	6,5	150	252	102	35	103	12	192,56	8,02	8592667036192
4CZ-8330-08	SL8	1,2	8	175	282	107	36	151	12	249,59	10,40	8592667036208

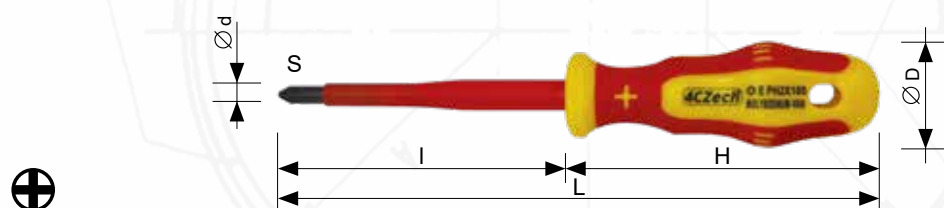

Šroubovák elektrikařský phillips profil 1000V
Insulated screwdriver phillips tip profil 1000V
Elektriker-Schraubendreher Phillips profil 1000V

kód/Code Bestellnummer	S	d (mm)	I (mm)	L (mm)	H (mm)	D (mm)	W (g)		DPC/RRP (Kč/czk)	DPC/RRP (EUR)	EAN13
4CZ-8331-00	PH0	3	80	160	80	27	31	12	88,43	3,68	8592667036215
4CZ-8331-01	PH1	5	100	195	95	32	61	12	105,79	4,41	8592667036222
4CZ-8331-02	PH2	6	100	202	102	35	82	12	136,36	5,68	8592667036239
4CZ-8331-03	PH3	8	150	257	107	36	141	12	196,69	8,20	8592667036246



Šroubovák elektrikařský pozidrive profil 1000V
Insulated screwdriver pozidrive tip profil 1000V
Elektriker-Schraubendreher Pozidrive profil 1000V

kód/Code Bestellnummer	S	d (mm)	I (mm)	L (mm)	H (mm)	D (mm)	W (g)		DPC/RRP (Kč/czk)	DPC/RRP (EUR)	EAN13
4CZ-8332-00	PZ0	3	80	160	80	27	31	12	91,74	3,82	8592667036253
4CZ-8332-01	PZ1	5	100	195	95	32	61	12	108,26	4,51	8592667036260
4CZ-8332-02	PZ2	6	100	202	102	35	82	12	138,84	5,79	8592667036277
4CZ-8332-03	PZ3	8	150	257	107	36	141	12	200,83	8,37	8592667036284

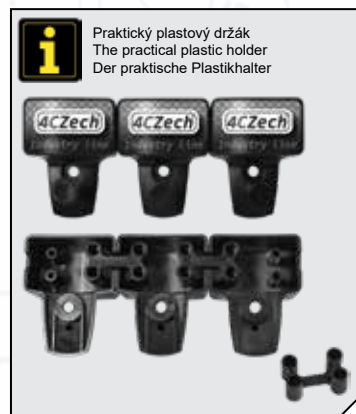

i Praktický plastový držák
The practical plastic holder
Der praktische Plastikhalter

i Informace o balení na straně 9
Packing information on page 9
Verpackungsinformationen auf Seite 9



Sada elektrikařských šroubováků profi 1000V 7-dílná v papírové krabici
Screwdriver set profi 1000V 7pcs in paper box
Elektriker-Schraubendreher-Satz profi 1000V 7 Stück im Karton

kód/Code	W		DPC/RRP	DPC/RRP	EAN13
Bestellnummer	(g)		(Kč/czk)	(EUR)	
4CZ-8557-70	570	1	809,92	33,75	8592667039063

obsah / content / Inhalt	velikost / size / Größe
Šroubovák elektrikařský plochý profi / Insulated screwdriver straight tip profi / Elektriker-Schraubendreher Schlitz profi	SL2,5x0,4; SL4,0x0,8; SL5,5x1,0
Šroubovák elektrikařský phillips profi / Insulated screwdriver phillips tip profi / Elektriker-Schraubendreher Phillips profi	PH1; PH2
Šroubovák elektrikařský pozidrive profi / Insulated screwdriver pozidrive tip profi / Elektriker-Schraubendreher Pozidriv profi	PZ1; PZ2



Sada elektrikařských šroubováků s výměnnou rukojetí profi 1000V 13-dílná v plastové krabičce
Screwdriver set for removable handle profi 1000V 13pcs in plastic box
Elektriker-Schraubendreher-Satz mit Wechselgriff profi 1000V 13 Stück in Plastikkasten

kód/Code	W		DPC/RRP	DPC/RRP	EAN13
Bestellnummer	(g)		(Kč/czk)	(EUR)	
4CZ-9988-01	750	1	1004,96	41,87	8592667123304

obsah / content / Inhalt	velikost / size / Größe
Šroubovák elektrikařský plochý profi 1000V pro výměnnou rukojeť Insulated screwdriver straight tip profi for removable handle Elektriker-Schraubendreher Schlitz profi 1000V für Wechselgriff	SL3; SL4; SL5,5; SL6,5
Šroubovák elektrikařský phillips profi 1000V pro výměnnou rukojeť Insulated screwdriver phillips tip profi 1000V for removable handle Elektriker-Schraubendreher Phillips profi 1000V für Wechselgriff	PH1; PH2
Šroubovák elektrikařský pozidrive profi 1000V pro výměnnou rukojeť Insulated screwdriver pozidrive tip profi 1000V for removable handle Elektriker-Schraubendreher Pozidriv profi 1000V für Wechselgriff	PZ1; PZ2
Šroubovák elektrikařský torx profi 1000V pro výměnnou rukojeť Insulated screwdriver torx tip profi 1000V for removable handle Elektriker-Schraubendreher torx profi 1000V für Wechselgriff	T10; T15; T20
Výměnná rukojeť profi 1000V / Removable handle profi 1000V / Wechselgriff profi 1000V	100mm
Jednopolová zkušební napětí 230V / Single-pole voltage tester 230V / Einpoliger Spannungsprüfer 230V	140mm

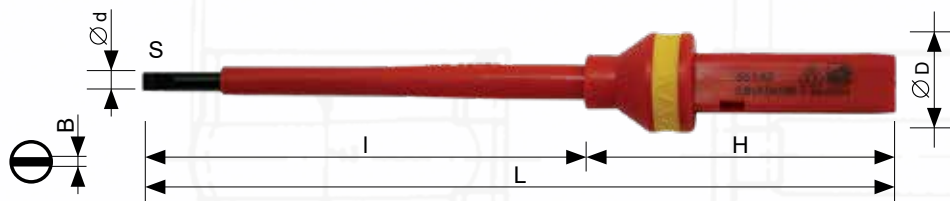

Šroubovák elektrikařský plochý profil 1000V pro výměnnou rukojeť
Insulated screwdriver straight tip profi for removable handle
Elektriker-Schraubendreher Schlitz profi 1000V für Wechselgriff

kód/Code Bestellnummer	typ	B (mm)	d (mm)	l (mm)	L (mm)	H (mm)	D (mm)	W (g)		DPC/RRP (Kč/czck)	DPC/RRP (EUR)	EAN13
4CZ-9988-07	SL3	0,5	3	100	160	60	20	40	10	66,94	2,79	8592667138919
4CZ-9988-06	SL4	0,8	4	100	160	60	20	36	10	66,94	2,79	8592667138902
4CZ-9988-05	SL5,5	1	5,5	100	160	60	20	25	10	66,94	2,79	8592667138896
4CZ-9988-04	SL6,5	1,2	6,5	100	160	60	20	19	10	66,94	2,79	8592667138889

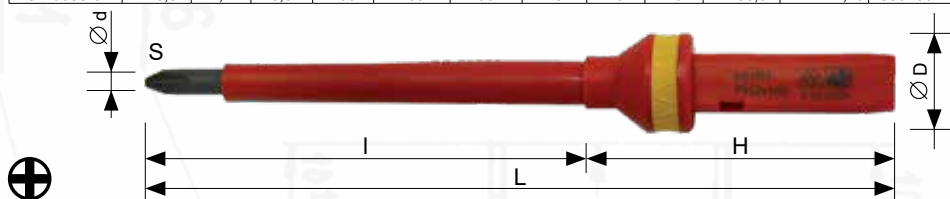

Šroubovák elektrikařský phillips profil 1000V pro výměnnou rukojeť
Insulated screwdriver phillips tip profi for removable handle
Elektriker-Schraubendreher Phillips profi 1000V für Wechselgriff

kód/Code Bestellnummer	typ	d (mm)	l (mm)	L (mm)	H (mm)	D (mm)	W (g)		DPC/RRP (Kč/czck)	DPC/RRP (EUR)	EAN13
4CZ-9988-09	PH1	4,5	80	140	60	20	38	10	66,94	2,79	8592667138933
4CZ-9988-08	PH2	6	100	160	60	20	27	10	66,94	2,79	8592667138926



Šroubovák elektrikařský pozidrive profil 1000V pro výměnnou rukojeť
Insulated screwdriver pozidrive tip profi for removable handle
Elektriker-Schraubendreher Pozidrive profi 1000V für Wechselgriff

kód/Code Bestellnummer	typ	d (mm)	l (mm)	L (mm)	H (mm)	D (mm)	W (g)		DPC/RRP (Kč/czck)	DPC/RRP (EUR)	EAN13
4CZ-9988-11	PZ1	4,5	80	140	60	20	38	10	66,94	2,79	8592667138957
4CZ-9988-10	PZ2	6	100	160	60	20	25	10	66,94	2,79	8592667138940

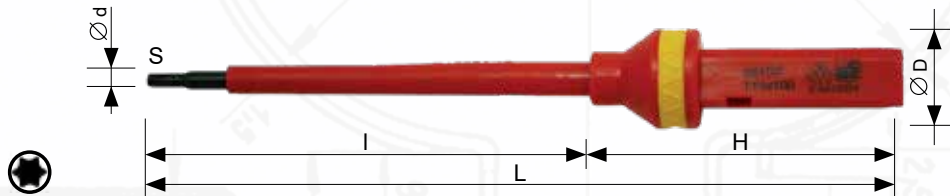

Šroubovák elektrikařský torx profil 1000V pro výměnnou rukojeť
Insulated screwdriver torx tip profi for removable handle
Elektriker-Schraubendreher torx profi 1000V für Wechselgriff

kód/Code Bestellnummer	typ	d (mm)	l (mm)	L (mm)	H (mm)	D (mm)	W (g)		DPC/RRP (Kč/czck)	DPC/RRP (EUR)	EAN13
4CZ-9988-14	T10	4	100	160	60	20	24	10	66,94	2,79	8592667138988
4CZ-9988-13	T15	4	100	160	60	20	24	10	66,94	2,79	8592667138971
4CZ-9988-12	T20	4	100	160	60	20	24	10	66,94	2,79	8592667138964



Výměnná rukojeť profi 1000V
Removable handle profi 1000V
Wechselgriff profi 1000V

kód/Code Bestellnummer	L (mm)	D (mm)	W (mm)		DPC/RRP (Kč/czck)	DPC/RRP (EUR)	EAN13
4CZ-9988-02	100	35	60	10	61,16	2,55	8592667138865



Jednopolová zkoušečka napětí 230V
One-pole voltage tester 230V
Einpoliger Spannungsprüfer 230V

kód/Code Bestellnummer	L (mm)	D (mm)	W (g)		DPC/RRP (Kč/czck)	DPC/RRP (EUR)	EAN13
4CZ-9988-031	140	15	16	10	48,76	2,03	8592667203617





Kód / Code / Bestellnummer

4CZ-839

Industry
line

CrMo



HRC
58 / 54



POUŽITÍ

Šroubovák určený pro montáž a opravy v náročných podmínkách. Dřík šroubováku ze zúšlechtné vysoce legované oceli s chromovaným povrchem, pracovní část dříku kalena a černěna. Ergonomická dvouplastová rukojeť s otvorem pro zavěšení. Tvar brání samovolnému pohybu při odložení. Dodáváno s praktickým plastovým držákem.



USABILITY

Screwdriver suitable for assembling and repairs under difficult conditions. Blade of a screwdriver from treated highly alloyed steel with chrome plated surface, working part of a blade is hardened and with black surface. Ergonomic twin plastic handle with opening for hanging. The form protects from spontaneous movement when put away. Supplied with practical plastic holder.



VERWENDUNG

Schraubendreher verwendet für die Installation und Reparaturen unter schwierigen Bedingungen. Der Schaft Schraubendreher gehärtetem Stahl mit Chrom-Finish, Arbeits rasta Klingen gehärtet und brüniert. Doppel-beschichteten ergonomischer Handgriff mit Loch zum Aufhängen. Die Form verhindert das versehentliche Bewegung während der Verschiebung. Ausgestattet mit einem handlichen Kunststoffhalter.

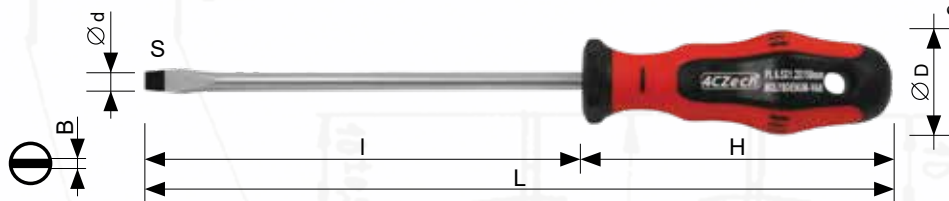

Šroubovák plochý profi
Screwdriver flat tip profi
Schraubendreher Schlitz profi

kód/Code Bestellnummer	S	B (mm)	d (mm)	I (mm)	L (mm)	H (mm)	D (mm)	W (g)		DPC/RRP (Kč/czk)	DPC/RRP (EUR)	EAN13
4CZ-8391-01	SL3	0,5	3	75	155	80	27	29	12	81,82	3,41	8592667035904
4CZ-8391-02	SL4	0,8	4	100	195	95	32	53	12	89,26	3,72	8592667035911
4CZ-8391-04	SL5,5	1	5	125	220	95	32	63	12	105,79	4,41	8592667035928
4CZ-8391-06	SL6,5	1,2	6	150	252	102	35	88	12	121,49	5,06	8592667035935
4CZ-8391-08	SL8	1,2	7,5	175	282	107	36	141	12	146,28	6,10	8592667035942

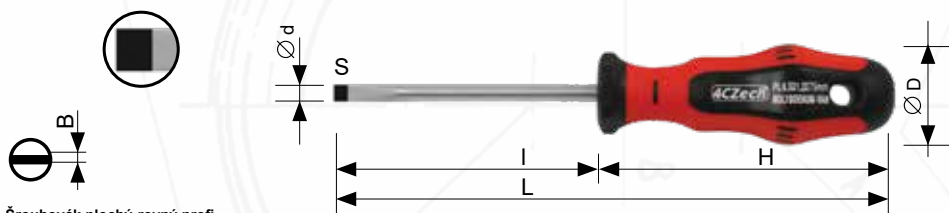

Šroubovák plochý-rovný profi
Screwdriver straight tip profi
Schraubendreher Schlitz-gerade profi

kód/Code Bestellnummer	S	B (mm)	d (mm)	I (mm)	L (mm)	H (mm)	D (mm)	W (g)		DPC/RRP (Kč/czk)	DPC/RRP (EUR)	EAN13
4CZ-9991-01	SL3	0,5	3	75	155	80	26	29	12	85,12	3,55	8592667111066
4CZ-9991-02	SL4	0,8	4	75	170	94	31	49	12	95,87	3,99	8592667111073
4CZ-9991-04	SL5,5	1	5,5	75	170	94	31	64	12	121,49	5,06	8592667111080
4CZ-9991-06	SL6,5	1,2	6,5	75	180	105	35	83	12	126,45	5,27	8592667111097
4CZ-9991-08	SL8	1,2	8	75	185	105	35	100	12	188,43	7,85	8592667111103

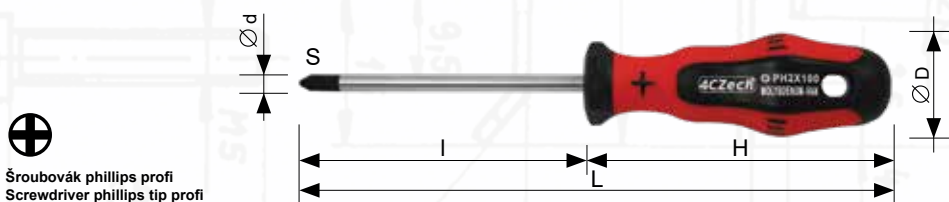

Šroubovák phillips profi
Screwdriver phillips tip profi
Schraubendreher Phillips profi

kód/Code Bestellnummer	S	d (mm)	I (mm)	L (mm)	H (mm)	D (mm)	W (g)		DPC/RRP (Kč/czk)	DPC/RRP (EUR)	EAN13
4CZ-8393-00	PH0	3	75	155	80	27	30	12	80,99	3,37	8592667035959
4CZ-8393-01	PH1	5	75	170	95	32	55	12	94,21	3,93	8592667035966
4CZ-8393-02	PH2	6	100	202	102	35	79	12	121,49	5,06	8592667035973
4CZ-8393-03	PH3	8	150	257	107	36	132	12	151,24	6,30	8592667035980

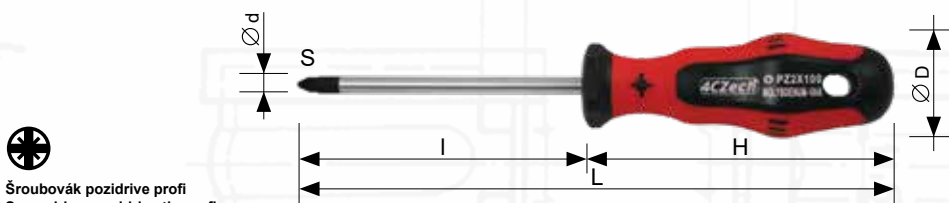

Šroubovák pozidrive profi
Screwdriver pozidrive tip profi
Schraubendreher Pozidriv profi

kód/Code Bestellnummer	S	d (mm)	I (mm)	L (mm)	H (mm)	D (mm)	W (g)		DPC/RRP (Kč/czk)	DPC/RRP (EUR)	EAN13
4CZ-8394-00	PZ0	3	75	155	80	27	30	12	85,12	3,55	8592667035997
4CZ-8394-01	PZ1	5	75	170	95	32	56	12	102,48	4,27	8592667036000
4CZ-8394-02	PZ2	6	100	202	102	35	78	12	127,27	5,30	8592667036017
4CZ-8394-03	PZ3	8	150	257	107	36	131	12	155,37	6,47	8592667036024



i Hrot s drážkami zabraňuje vyklouznutí z hlavy šroubu.
Tip with grooves to prevent slipping of the screw head.

Tipp mit Rillen Abrutschen des Schraubenkopfes zu verhindern.



i Informace o balení na straně 9
Packing information on page 9
Verpackungsinformationen auf Seite 9

i Praktický plastový držák
The practical plastic holder
Der praktische Plastikhalter





Šroubovák čtyřhran profi
Screwdriver square tip profi
Schraubendreher 4-kant profi

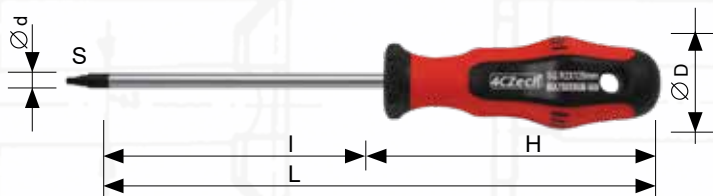

kód/Code Bestellnummer	typ/type	d (mm)	l (mm)	L (mm)	H (mm)	D (mm)	W (g)		DPC/RRP (Kč/czk)	DPC/RRP (EUR)	EAN13
4CZ-9990-00	SQ0	5	90	190	100	32	60	12	100,83	4,20	8592667111028
4CZ-9990-01	SQ1	5	90	190	100	32	60	12	113,22	4,72	8592667111035
4CZ-9990-02	SQ2	6	125	225	100	36	85	12	134,71	5,61	8592667111042
4CZ-9990-03	SQ3	8	150	255	105	36	131	12	151,24	6,30	8592667111059



Šroubovák 6HR s kuličkou profi
Screwdriver hexagonal ball tip profi
Schraubendreher 6-kant mit Kugelkopf profi

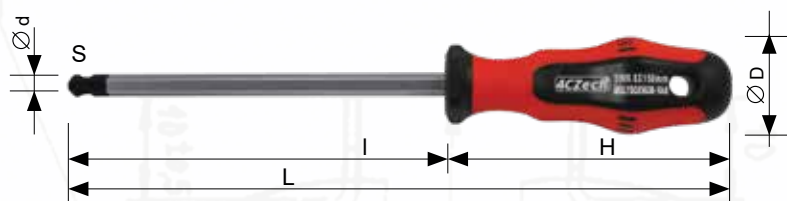

kód/Code Bestellnummer	typ/type	d (mm)	l (mm)	L (mm)	H (mm)	D (mm)	W (g)		DPC/RRP (Kč/czk)	DPC/RRP (EUR)	EAN13
4CZ-8398-02	HB2.5	2,5	100	180	80	27	29	12	113,22	4,72	8592667110953
4CZ-8398-03	HB3	3	100	190	90	27	30	12	119,01	4,96	8592667110960
4CZ-8398-04	HB4	4	100	190	90	31	54	12	123,97	5,17	8592667110977
4CZ-8398-05	HB5	5	100	190	90	31	62	12	130,58	5,44	8592667110984
4CZ-8398-06	HB6	6	125	225	105	35	90	12	145,45	6,06	8592667110991
4CZ-8398-08	HB8	8	150	255	105	36	141	12	181,82	7,58	8592667111004
4CZ-8398-10	HB10	10	150	255	105	36	188	12	203,31	8,47	8592667111011



Šroubovák torx profi
Screwdriver torx tip profi
Schraubendreher Torx profi

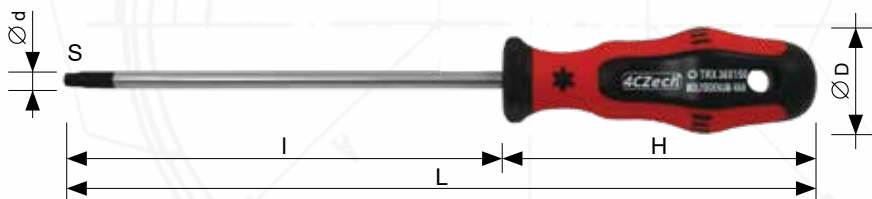

kód/Code Bestellnummer	typ/type	d (mm)	l (mm)	L (mm)	H (mm)	D (mm)	W (g)		DPC/RRP (Kč/czk)	DPC/RRP (EUR)	EAN13
4CZ-8395-06	T6	3	75	155	80	27	29	12	105,79	4,41	8592667036031
4CZ-8395-07	T7	3	75	155	80	27	29	12	105,79	4,41	8592667036048
4CZ-8395-08	T8	3	75	155	80	27	29	12	105,79	4,41	8592667036055
4CZ-8395-09	T9	4	75	170	95	32	51	12	105,79	4,41	8592667036062
4CZ-8395-10	T10	4	75	170	95	32	51	12	105,79	4,41	8592667036079
4CZ-8395-15	T15	4	100	195	95	32	55	12	108,26	4,51	8592667036086
4CZ-8395-20	T20	4	100	195	95	32	51	12	126,45	5,27	8592667036093
4CZ-8395-25	T25	5	125	220	95	32	63	12	142,15	5,92	8592667036109
4CZ-8395-27	T27	5	125	220	95	32	63	12	160,33	6,68	8592667036116
4CZ-8395-30	T30	6	150	252	102	35	90	12	163,64	6,82	8592667036123
4CZ-8395-40	T40	8	150	257	107	36	130	12	182,64	7,61	8592667036130

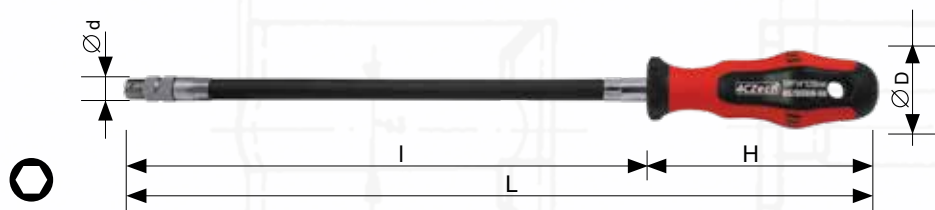

Držák bitů 1/4" FLEXI s rukojetí profi
Flexible driver 1/4" with handle profi
Bithalter FLEXI 1/4" mit Handgriff profi

kód/Code Bestellnummer	d (mm)	l (mm)	L (mm)	H (mm)	D (mm)	W (g)		DPC/RRP (Kč/czk)	DPC/RRP (EUR)	EAN13
4CZ-8323-10	10	170	270	100	35	137	12	136,36	5,68	8592667110922
4CZ-8323-11	10	250	350	100	35	160	12	199,17	8,30	8592667110939

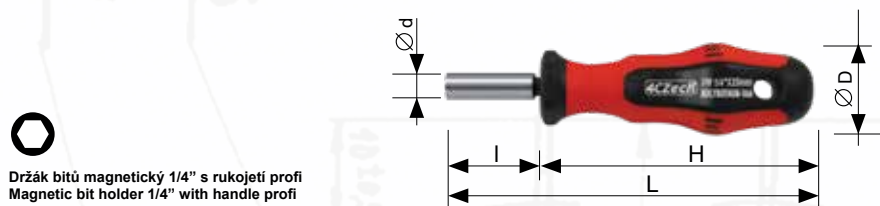

Držák bitů magnetický 1/4" s rukojetí profi
Magnetic bit holder 1/4" with handle profi
Bithalter magnetisch 1/4" mit Handgriff profi

kód/Code Bestellnummer	d (mm)	l (mm)	L (mm)	H (mm)	D (mm)	W (g)		DPC/RRP (Kč/czk)	DPC/RRP (EUR)	EAN13
4CZ-8320-09	10	35	135	100	35	70	12	121,49	5,06	8592667110885
4CZ-8320-10	10	70	170	100	35	83	12	127,27	5,30	8592667110892

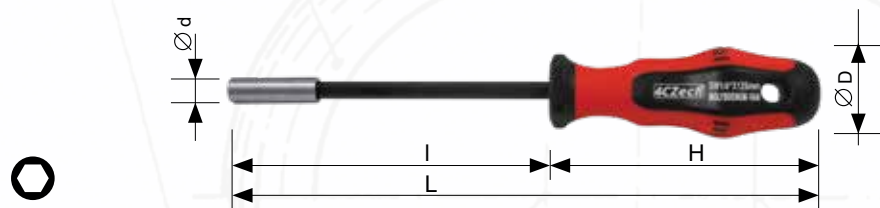

Držák bitů magnetický 1/4" s rukojetí profi
Magnetic bit holder 1/4" with handle profi
Bithalter magnetisch 1/4" mit Handgriff profi

kód/Code Bestellnummer	d (mm)	l (mm)	L (mm)	H (mm)	D (mm)	W (g)		DPC/RRP (Kč/czk)	DPC/RRP (EUR)	EAN13
4CZ-8367-00	10	125	225	100	35	101	12	217,36	9,06	8592667110946

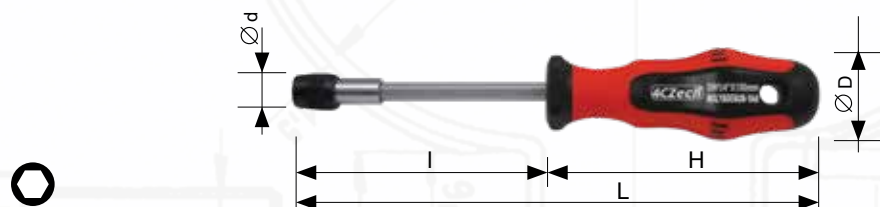

Držák bitů 1/4" s rukojetí s pojistkou profi
Quick release 1/4" with handle profi
Bithalter 1/4" mit Handgriff mit Sicherung profi

kód/Code Bestellnummer	d (mm)	l (mm)	L (mm)	H (mm)	D (mm)	W (g)		DPC/RRP (Kč/czk)	DPC/RRP (EUR)	EAN13
4CZ-8320-18	18	35	135	100	35	75	12	158,68	6,61	8592667110908
4CZ-8320-19	19	100	200	100	35	100	12	192,56	8,02	8592667110915



Sada šroubováků PL,PH 5-dílná v papírové krabici
Screwdriver set PL,PH 5pcs in paper box
Schraubendreher-Set PL,PH 5 Stück im Karton

kód/Code Bestellnummer	W (g)		DPC/RRP (Kč/czk)	DPC/RRP (EUR)	EAN13
4CZ-8558-50	416	1	480,99	20,04	8592667039070

obsah / content / Inhalt	velikost / size / Größe
Šroubovák plochý profi Screwdriver flat tip profi Schraubendreher Schlitz profi	SL3; SL4; SL6,5
Šroubovák phillips profi Screwdriver phillips tip profi Schraubendreher Phillips profi	PH1; PH2

Sada šroubováků PL,PZ 5-dílná v papírové krabici
Screwdriver set PL,PZ 5pcs in paper box
Schraubendreher-Set PL,PZ 5 Stück im Karton

kód/Code Bestellnummer	W (g)		DPC/RRP (Kč/czk)	DPC/RRP (EUR)	EAN13
4CZ-8558-51	416	1	494,21	20,59	8592667039087

obsah / content / Inhalt	velikost / size / Größe
Šroubovák plochý profi Screwdriver flat tip profi Schraubendreher Schlitz profi	SL3; SL4; SL6,5
Šroubovák pozidrive profi Screwdriver pozidrive tip profi Schraubendreher Pozidriv profi	PZ1; PZ2



Sada šroubováků PL 5-dílná v papírové krabici
Screwdriver set PL 5pcs in paper box
Schraubendreher-Set PL 5 Stück im Karton

kód/Code Bestellnummer	W (g)		DPC/RRP (Kč/czk)	DPC/RRP (EUR)	EAN13
4CZ-8558-60	492	1	533,88	22,25	8592667039094

obsah / content / Inhalt	velikost / size / Größe
Šroubovák plochý profi Screwdriver flat tip profi Schraubendreher Schlitz profi	SL3; SL4; SL5,5; SL6,5; SL8

Sada šroubováků PH 5-dílná v papírové krabici
Screwdriver set PH 5pcs in paper box
Schraubendreher-Set PH 5 Stück im Karton

kód/Code Bestellnummer	W (g)		DPC/RRP (Kč/czk)	DPC/RRP (EUR)	EAN13
4CZ-8558-62	490	1	558,68	23,28	8592667039100

obsah / content / Inhalt	velikost / size / Größe
Šroubovák phillips profi Screwdriver phillips tip profi Schraubendreher Phillips profi	PH0; PH1; PH2; PH2; PH3



Sada šroubováků PZ 5-dílná v papírové krabici
Set of screwdrivers PZ 5pcs in paper box
Schraubendreher-Set PZ 5 Stück im Karton

kód/Code Bestellnummer	W (g)	1	DPC/RRP (Kč/czK)	DPC/RRP (EUR)	EAN13
4CZ-8558-64	490	1	588,43	24,52	8592667039117

obsah / content / Inhalt	velikost / size / Größe
Šroubovák pozdrivé profi Screwdriver pozdrivé tip profi Schraubendreher Pozidrív profi	PZ0; PZ1; PZ2; PZ3



Sada šroubováků TRX 5-dílná v papírové krabici
Set of screwdrivers TRX 5pcs in paper box
Schraubendreher-Set TRX 5 Stück im Karton

kód/Code Bestellnummer	W (g)	1	DPC/RRP (Kč/czK)	DPC/RRP (EUR)	EAN13
4CZ-8558-66	424	1	635,54	26,48	8592667039124

obsah / content / Inhalt	velikost / size / Größe
Šroubovák torx profi Screwdriver torx tip profi Schraubendreher torx profi	T10; T15; T20; T25; T30



Sada šroubováků PL,PH,PZ 7-dílná v papírové krabici
Set of screwdrivers PL,PH,PZ 7pcs in paper box
Schraubendreher-Set PL,PH,PZ 7 Stück im Karton

kód/Code Bestellnummer	W (g)	1	DPC/RRP (Kč/czK)	DPC/RRP (EUR)	EAN13
4CZ-8558-70	672	1	692,56	28,86	8592667039131

obsah / content / Inhalt	velikost / size / Größe
Šroubovák plochý profi Screwdriver flat tip profi Schraubendreher Schlitz profi	SL3; SL5,5; SL6,5
Šroubovák phillips profi Screwdriver phillips tip profi Schraubendreher Phillips profi	PH1; PH2
Šroubovák pozdrivé profi Screwdriver pozdrivé tip profi Schraubendreher Pozidrív profi	PZ1; PZ2



Sada šroubováků PL,PH,PZ 7-dílná v papírové krabici + držák
Set of screwdrivers PL,PH,PZ 7pcs in paper box + holder
Schraubendreher-Set PL,PH,PZ 7 Stück im Karton + halter

kód/Code Bestellnummer	W (g)	1	DPC/RRP (Kč/czK)	DPC/RRP (EUR)	EAN13
4CZ-8558-90	694	1	867,77	36,16	8592667039148

obsah / content / Inhalt	velikost / size / Größe
Šroubovák plochý profi Screwdriver flat tip profi Schraubendreher Schlitz profi	SL3; SL5,5; SL6,5
Šroubovák phillips profi Screwdriver phillips tip profi Schraubendreher Phillips profi	PH1; PH2
Šroubovák pozdrivé profi Screwdriver pozdrivé tip profi Schraubendreher Pozidrív profi	PZ1; PZ2
Držák - magnetizační / demagnetizační funkce holder - The magnetization / The demagnetization function Halter - Die Magnetisierung / Die Entmagnetisierung Funktion	



Magnetizační funkce
The magnetization function
Die Magnetisierung Funktion



Demagnetizační funkce
The demagnetization function
Die Entmagnetisierung Funktion



Stojánek se šroubováky
The stand with electrical screwdrivers
Elektrikerschraubendreherständer

kód/Code Bestellnummer	velikost/size/Größe	W (g)		DPC/RRP (Kč/czk)	DPC/RRP (EUR)	EAN13
4CZ-9999-01	535x355x300mm	8030	1	12060,33	502,51	8592667121348

obsah / content / Inhalt	velikost / size / Größe
Šroubovák elektrifikácký plochý profi Insulated screwdriver straight tip profi Elektriker-Schraubendreher Schlitz profi	8x SL2,5; 8x SL3; 8x SL3,5; 5x SL4; 5x SL5,5; 5x SL6,5; 5x SL8
Šroubovák elektrifikácký phillips profi Insulated screwdriver phillips tip profi Elektriker-Schraubendreher Phillips profi	8x PH0; 5x PH1; 5x PH2; 5x PH3
Šroubovák elektrifikácký pozdrive profi Insulated screwdriver pozdrive tip profi Elektriker-Schraubendreher Pozdriv profi	2x PZ0; 2x PZ1; 2x PZ2; 2x PZ3



kód/Code Bestellnummer	velikost/size/Größe	W (g)		DPC/RRP (Kč/czk)	DPC/RRP (EUR)	EAN13
4CZ-9999-02	535x355x300mm	8085	1	12252,89	510,54	8592667121355

obsah / content / Inhalt	velikost / size / Größe
Šroubovák plochý profi Screwdriver flat tip profi / Schraubendreher Schlitz profi	2x SL3; 2x SL4; 2x SL5,5; 3x SL6,5; 3x SL8
Šroubovák pozdrive profi Screwdriver pozdrive tip profi / Schraubendreher Pozdriv profi	2x PZ0; 2x PZ1; 2x PZ2; 2x PZ3
Šroubovák phillips profi Screwdriver phillips tip profi / Schraubendreher Phillips profi	2x PH0; 2x PH1; 2x PH2; 2x PH3
Šroubovák torx profi / Screwdriver torx tip profi Schraubendreher torx profi	3x T6; 3x T7; 3x T8; 3x T9; 3x T10; 3x T15; 3x T20; 3x T25; 3x T27; 3x T30; 3x T40
Šroubovák 6HR s kulíčkou profi Screwdriver hexagonal ball tip profi 6HR-Schraubendreher mit Kugelchen profi	2x HB2,5; 2x HB3; 2x HB4; 2x HB5; 2x HB6x HB8; 2x HB10
Držák bitů magnetický 1/4" s rukojetí profi / Magnetic bit holder 1/4" with handle profi / Bithalter magnetisch 1/4" mit Handgriff profi	1x 35mm; 1x 70mm; 1x125mm
Držák bitů 1/4" s rukojetí s pojistkou profi Quick release 1/4" with handle profi Bithalter 1/4" mit Handgriff mit Sicherung profi	1x 35mm; 1x 100mm
Držák bitů 1/4" FLEXI s rukojetí profi / Flexible driver 1/4" with handle profi / Bithalter FLEXI 1/4" mit Handgriff profi	1x 250mm



kód/Code Bestellnummer	velikost/size/Größe	W (g)		DPC/RRP (Kč/czk)	DPC/RRP (EUR)	EAN13
4CZ-9999-03	535x355x300mm	8930	1	10281,82	428,41	8592667121362

obsah / content / Inhalt	velikost / size / Größe
Šroubovák plochý profi Screwdriver flat tip profi / Schraubendreher Schlitz profi	5x SL3; 5x SL4; 5x SL5,5; 5x SL6,5; 5x SL8
Šroubovák pozdrive profi Screwdriver pozdrive tip profi / Schraubendreher Pozdriv profi	4x PZ0; 4x PZ1; 6x PZ2; 5x PZ3
Šroubovák phillips profi Screwdriver phillips tip profi / Schraubendreher Phillips profi	4x PH0; 4x PH1; 4x PH2; 3x PH3
Držák bitů 1/4" s rukojetí profi Magnetic bit holder 1/4" profi / Bithalter 1/4" mit Handgriff profi	2x 35mm; 2x 70mm; 2x125mm
Držák bitů 1/4" s rukojetí s pojistkou profi Quick release 1/4" profi / Profi-Bithalter 1/4" mit Handgriff und mit Ansatzsicherung	2x 35mm; 2x 100mm
Držák bitů magnetický 1/4" s rukojetí profi / Magnetic bit holder 1/4" with handle profi / Bithalter magnetisch 1/4" mit Handgriff profi	2x 250mm
Držák bitů 1/4" s rukojetí s pojistkou profi / Quick release 1/4" with handle profi Bithalter 1/4" mit Handgriff mit Sicherung profi	1x 35mm; 1x 100mm
Držák bitů 1/4" FLEXI s rukojetí profi / Flexible driver 1/4" with handle profi / Bithalter FLEXI 1/4" mit Handgriff profi	1x 250mm



kód/Code Bestellnummer	velikost/size/Größe	W (g)		DPC/RRP (Kč/czk)	DPC/RRP (EUR)	EAN13
4CZ-9999-04	535x355x300mm	9089	1	13749,59	572,90	8592667121379

obsah / content / Inhalt	velikost / size / Größe
Šroubovák plochý profi Screwdriver flat tip profi / Schraubendreher Schlitz profi	5x SL3; 5x SL4; 5x SL5,5; 5x SL6,5; 5x SL8
Šroubovák pozdrive profi Screwdriver pozdrive tip profi / Schraubendreher Pozdriv profi	2x PZ0; 3x PZ1; 3x PZ2; 3x PZ3
Šroubovák phillips profi Screwdriver phillips tip profi / Schraubendreher Phillips profi	2x PH0; 3x PH1; 3x PH2; 3x PH3
Šroubovák torx profi / Screwdriver torx tip profi Schraubendreher torx profi	2x T6; 2x T7; 2x T8; 2x T9; 2x T10; 2x T15; 2x T20; 2x T25; 2x T27; 2x T30; 2x T40
Šroubovák elektrifikácký plochý profi Insulated screwdriver straight tip profi / Elektriker-Schraubendreher Schlitz profi	2x SL2,5; 2x SL3; 2x SL3,5; 2x SL4; 2x SL5,5; 2x SL6,5; 2x SL8
Šroubovák elektrifikácký phillips profi Insulated screwdriver phillips tip profi / Elektriker-Schraubendreher Phillips profi	2x PH0; 3x PH1; 3x PH2; 3x PH3
Šroubovák elektrifikácký pozdrive profi Insulated screwdriver pozdrive tip profi / Elektriker-Schraubendreher Pozdriv profi	2x PZ0; 3x PZ1; 3x PZ2; 3x PZ3
Šroubovák FLEXI pro nástavce profi Flexible driver 1/4" profi / FLEXI-Schraubendreher für sätze profi	1x 250mm



Stojánek na šroubováky prázdný
The holder for screwdrivers empty
Schraubendreherständer leer

kód/Code Bestellnummer	velikost/size/Größe		W	DPC/RRP (Kč/czk)	DPC/RRP (EUR)	EAN13
4CZ-9992	535x355x300mm	1961	1	1640,50	68,35	8592667538450



Na přání zákazníka můžeme vytvořit sady i z ostatních typů šroubováků dle nabídky v katalogu.

If required by a customer we can also make sets from other screwdriver types according to the catalogue offer.

Auf Wunsch des Kunden können wir auch Sets von anderen Typen der Schraubendreher nach dem Katalogangebot zusammensetzen.



Kód / Code / Bestellnummer

4CZ-833

Industry
line

CrMo



HRC
58 / 54



POUŽITÍ

Šroubovák určený pro montáž a opravy jemné elektroniky (např. telefony, měřicí přístroje, fotoaparáty apod.), vhodný pro hodináře, zlatníky, optiky i modeláře. Dřík šroubováku ze zúšlechtně vysoce legované oceli s chromovaným povrchem, pracovní část dříku kalena a černěna. Ergonomická dvouplastová dvoukomponentní rukojeť s otvorem pro zavěšení a otočným koncem.



USABILITY

Screwdriver suitable for assembling and repairs of fine electronics (e.g. mobile phones, measuring instruments or cameras), used by clockmakers, jewellers, opticians and modellers. Blade of a screwdriver from treated highly alloyed steel with chrome plated surface, working part of a blade is hardened and with black surface. Ergonomic twin plastic handle with opening for hanging and revolving top.



VERWENDUNG

Schraubendreher verwendet für die Installation und Reparatur empfindliche Elektronik (zB Telefone, Messgeräte, Kameras, etc.) geeignet für Uhrmacher, Juweliere, Optiker und Modellbauer. Der Schaft Schraubendreher gehärtetem Stahl mit Chrom-Finish, Arbeits rasta Klingen gehärtet und brüniert. Der doppelwandige Ergonomischer Zwei-Komponenten-Griff mit Aufhängeloch und Dreh Ende.

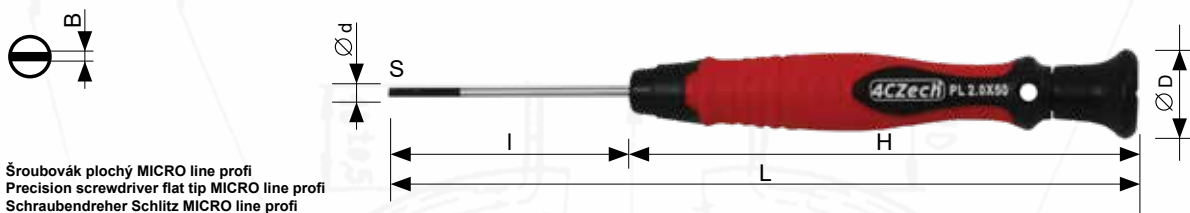

Šroubovák plochý MICRO line profi
Precision screwdriver flat tip MICRO line profi
Schraubendreher Schlitz MICRO line profi

kód/Code Bestellnummer	S	B (mm)	d (mm)	I (mm)	L (mm)	H (mm)	D (mm)	W (g)		DPC/RRP (Kč/czsk)	DPC/RRP (EUR)	EAN13
4CZ-8335-51	SL1,5	0,25	2	50	150	100	17	12	12	66,12	2,75	8592667038776
4CZ-8335-53	SL2	0,4	2	50	150	100	17	18	12	66,12	2,75	8592667038790
4CZ-8335-56	SL3	0,5	3	50	150	100	17	20	12	66,12	2,75	8592667038813
4CZ-8335-54	SL2,5	0,4	2,5	75	175	100	17	20	12	66,12	2,75	8592667038806
4CZ-8335-52	SL2,5	0,4	2,5	100	200	100	17	20	12	66,12	2,75	8592667038783
4CZ-8335-55	SL3	0,5	3	100	200	100	17	23	12	66,12	2,75	8592667040199
4CZ-8335-57	SL4	0,8	4	100	200	100	17	28	12	66,12	2,75	8592667038820

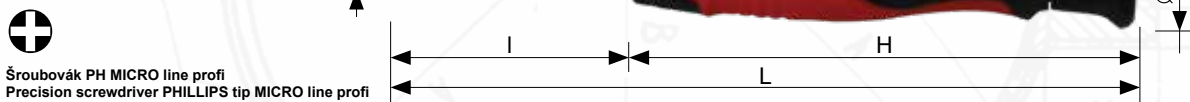

Šroubovák PH MICRO line profi
Precision screwdriver PHILLIPS tip MICRO line profi
Schraubendreher PHILLIPS MICRO line profi

kód/Code Bestellnummer	S	d (mm)	I (mm)	L (mm)	H (mm)	D (mm)	W (g)		DPC/RRP (Kč/czsk)	DPC/RRP (EUR)	EAN13
4CZ-8336-51	PH000	2	50	150	100	17	14	12	66,12	2,75	8592667038837
4CZ-8336-52	PH00	2	50	150	100	17	17	12	66,12	2,75	8592667038844
4CZ-8336-53	PH0	2,5	50	150	100	17	18	12	66,12	2,75	8592667038851
4CZ-8336-54	PH1	3	50	150	100	17	20	12	66,12	2,75	8592667038868

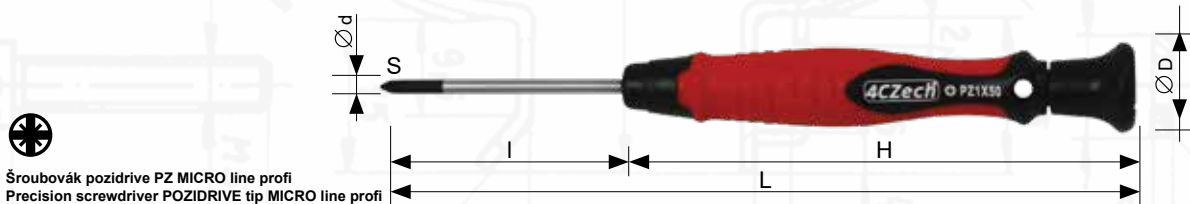

Šroubovák pozidrive PZ MICRO line profi
Precision screwdriver POZIDRIVE tip MICRO line profi
Schraubendreher Pozidriv MICRO line profi

kód/Code Bestellnummer	S	d (mm)	I (mm)	L (mm)	H (mm)	D (mm)	W (g)		DPC/RRP (Kč/czsk)	DPC/RRP (EUR)	EAN13
4CZ-8337-50	PZ0	3	50	150	100	17	19	12	66,12	2,75	8592667038875
4CZ-8337-51	PZ1	3	50	150	100	17	19	12	66,12	2,75	8592667038882

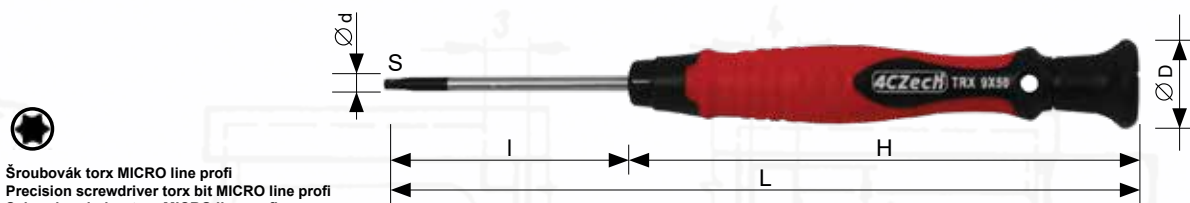

Šroubovák torx MICRO line profi
Precision screwdriver torx bit MICRO line profi
Schraubendreher torx MICRO line profi

kód/Code Bestellnummer	S	d (mm)	I (mm)	L (mm)	H (mm)	D (mm)	W (g)		DPC/RRP (Kč/czsk)	DPC/RRP (EUR)	EAN13
4CZ-8338-55	T5	3	50	150	100	17	19	12	66,12	2,75	8592667038905
4CZ-8338-56	T6	3	50	150	100	17	19	12	66,12	2,75	8592667038912
4CZ-8338-57	T7	3	50	150	100	17	19	12	66,12	2,75	8592667038929
4CZ-8338-58	T8	3	50	150	100	17	19	12	66,12	2,75	8592667038936
4CZ-8338-59	T9	3	50	150	100	17	19	12	66,94	2,79	8592667038943
4CZ-8338-60	T10	3	50	150	100	17	19	12	66,94	2,79	8592667038950
4CZ-8338-65	T15	4	50	150	100	17	23	12	66,94	2,79	8592667038967
4CZ-8338-70	T20	4	75	175	100	17	27	12	66,94	2,79	8592667038974



Součástí plastové krabičky je magnetizátor, lupa a organizér.
The part of plastic box is magnetizer, magnifier and organizer.
Ein Teil der Kunststoff-Box ist Magnetiseur, Lupen und Veranstalter.

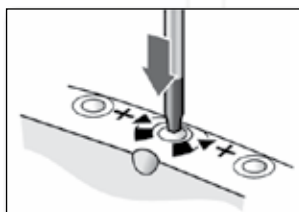

Magnetizační funkce
The magnetization function
Die Magnetisierung Funktion

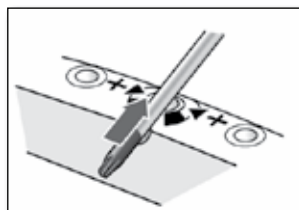

Demagnetizační funkce
The demagnetization function
Die Entmagnetisierung Funktion



Součástí plastové krabičky je magnetizátor, lupa a organizér.
The part of plastic box is magnetizer, magnifier and organizer.
Ein Teil der Kunststoff-Box ist Magnetiseur, Lupen und Veranstalter.

Sada šroubováků TRX 6-dílná v plastové krabičce
Screwdrivers set TRX 6pcs in plastic box
Schraubendreher-Set TRX 6 Stück im Plastikkasten

kód/Code Bestellnummer	W (g)	DPC/RRP (Kč/czsk)	DPC/RRP (EUR)	EAN13	
4CZ-8626-23	250	1	374,38	15,60	8592667038981

obsah / content / Inhalt	velikost / size / Größe
Šroubovák torx MICRO line profi Precision screwdriver torx bit MICRO line profi Schraubendreher torx MICRO line profi	T5; T6; T7; T8; T9; T10

Sada šroubováků PL,PH 6-dílná v plastové krabičce
Screwdrivers set PL,PH 6pcs in plastic box
Schraubendreher-Set PL,PH 6 Stück im Plastikkasten

kód/Code Bestellnummer	W (g)	DPC/RRP (Kč/czsk)	DPC/RRP (EUR)	EAN13	
4CZ-8626-51	250	1	387,60	16,15	8592667038998

obsah / content / Inhalt	velikost / size / Größe
Šroubovák plochý MICRO line profi Precision screwdriver flat tip MICRO line profi Schraubendreher Schlitz MICRO line profi	SL1,5/50; SL2/50; SL3/50
Šroubovák PH MICRO line profi Precision screwdriver PHILLIPS tip MICRO line profi Schraubendreher PHILLIPS MICRO line profi	PH00/50; PH0/50; PH1/50



Sada šroubováků TRX 6-dílná v plastové krabičce, 10 sad v kartonu
Screwdrivers set TRX 6pcs in plastic box, 10 sets in paper box
Schraubendreher-Set TRX 6 Stück im Plastikkasten, 10 Sätzen im Karton

kód/Code Bestellnummer	W (g)	DPC/RRP (Kč/czsk)	DPC/RRP (EUR)	EAN13	
4CZ-8626-23-B	2500	1	3728,93	155,37	8592667040113

obsah / content / Inhalt	velikost / size / Größe
Sada šroubováků TRX 6-dílná v plastové krabičce Screwdrivers set TRX 6pcs in plastic box Schraubendreher-Set TRX 6 Stück im Plastikkasten	10x sada / 10x set / 10x Set



Sada šroubováků PL, PH 6-dílná v plastové krabičce, 10 sad v kartonu
Screwdrivers set PL, PH 6pcs in plastic box, 10 sets in paper box
Schraubendreher-Set PL, PH 6 Stück im Plastikkasten, 10 Sätzen im Karton

kód/Code Bestellnummer	W (g)	DPC/RRP (Kč/czsk)	DPC/RRP (EUR)	EAN13	
4CZ-8626-51-B	2500	1	3857,02	160,71	8592667040120

obsah / content / Inhalt	velikost / size / Größe
Sada šroubováků PL,PH 6-dílná v plastové krabičce Screwdrivers set PL,PH 6pcs in plastic box Schraubendreher-Set PL,PH 6 Stück im Plastikkasten	10x sada / 10x set / 10x Set



Kód / Code / Bestellnummer

4CZ-70, 4CZ-71, 4CZ-87, 4CZ-99

Industry
line

CrNi



HRC
58 / 54



POUŽITÍ

Šroubovák určený pro montáž a opravy v náročných podmínkách. Díky šroubováku z tepelně zpracované, legované chrom-niklové oceli s chromovaným povrchem odolným proti korozi, s maximální tuhostí a odolností proti kroucení. Pracovní část dřívku kalena a černěna. Ergonomická celulózo-acetátová rukojeť, odolná proti rozbití, chemikáliím, olejům a tukům. Tvar brání samovolnému pohybu při odložení. Dodáváno s praktickým plastovým držákem.



USABILITY

Screwdriver intended for assembly and repairs in demanding conditions. The screwdriver's shank is made of heat-treated, chrome-nickel alloy steel with a corrosion-resistant chrome finish, with maximum rigidity and resistance to twisting. The working part of the shank is hardened and blackened. Ergonomic cellulose acetate handle, shatterproof, chemical, oil and grease resistant. The shape prevents spontaneous movement when put away. Supplied with a practical plastic holder.



VERWENDUNG

Schraubendreher für die Montage und Reparatur unter anspruchsvollen Bedingungen. Schraubendreherschaft aus wärmebehandeltem Chrom-Nickel-Stahl mit korrosionsbeständiger, verchromter Oberfläche für höchste Steifigkeit und Verwindungssteifigkeit. Arbeitsteil des Schaftes gehärtet und geschwärzt. Ergonomischer Griff aus Zelluloseacetat, bruchfest, resistent gegen Chemikalien, Öle und Fette. Die Form verhindert spontane Bewegungen beim Absetzen. Wird mit praktischem Kunststoffhalter geliefert.

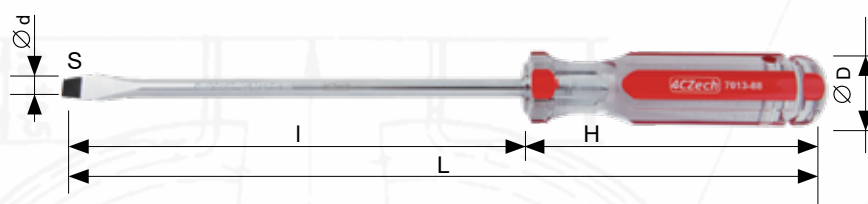

Šroubovák PL JUMBO
Screwdriver SL JUMBO
Schraubendreher Schlitz JUMBO

kód/Code Bestellnummer	S	B (mm)	d (mm)	I (mm)	L (mm)	H (mm)	D (mm)	W (g)		DPC/RRP (Kč/czk)	DPC/RRP (EUR)	EAN13
4CZ-7013-33	SL3,2	0,5	3,2	75	140	66	16	29	12	63,64	2,65	8592667193291
4CZ-7013-34	SL3,2	0,5	3,2	100	166	66	16	33	12	66,12	2,75	8592667193307
4CZ-7013-54	SL5	0,8	5,0	100	189	89	25	73	12	102,48	4,27	8592667193314
4CZ-7013-56	SL5	0,8	5,0	150	240	89	25	79	12	106,61	4,44	8592667193321
4CZ-7013-61	SL6	1	6,0	40	91	51	29	52	12	89,26	3,72	8592667193338
4CZ-7013-64	SL6	1	6,0	100	205	105	29	103	12	129,75	5,41	8592667193345
4CZ-7013-66	SL6	1	6,0	150	255	105	29	115	12	136,36	5,68	8592667193352
4CZ-7013-68	SL6	1	6,0	200	305	105	29	125	12	145,45	6,06	8592667193369
4CZ-7013-86	SL8	1	8,0	150	275	125	31,5	180	6	177,69	7,40	8592667193376
4CZ-7013-88	SL8	1	8	200	325	125	31,5	193	6	187,60	7,82	8592667193383

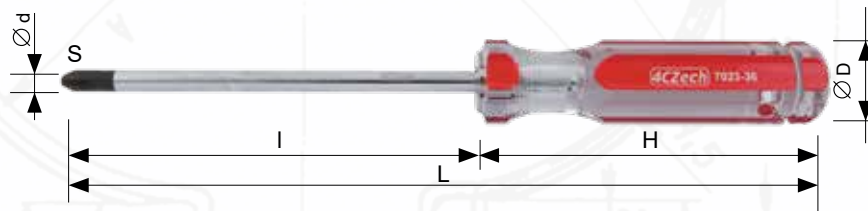

Šroubovák PH JUMBO
Screwdriver PH JUMBO
Schraubendreher JUMBO

kód/Code Bestellnummer	S	d (mm)	I (mm)	L (mm)	H (mm)	D (mm)	W (g)		DPC/RRP (Kč/czk)	DPC/RRP (EUR)	EAN13
4CZ-7023-03	PH0	3,2	75	141	66	16	30	12	63,64	2,65	8592667193420
4CZ-7023-04	PH0	3,2	100	166	66	16	31	12	66,12	2,75	8592667193437
4CZ-7023-13	PH1	5	75	164	89	25	66	12	100,83	4,20	8592667193444
4CZ-7023-14	PH1	5	100	189	89	25	73	12	102,48	4,27	8592667193451
4CZ-7023-16	PH1	5	150	239	89	25	80	12	106,61	4,44	8592667193468
4CZ-7023-21	PH2	6	40	91	51	29	52	12	89,26	3,72	8592667193475
4CZ-7023-24	PH2	6	100	206	106	29	104	12	129,75	5,41	8592667193482
4CZ-7023-26	PH2	6	150	256	106	29	116	12	136,36	5,68	8592667193499
4CZ-7023-28	PH2	6	200	306	106	29	126	12	145,45	6,06	8592667193505
4CZ-7023-36	PH3	8	150	278	128	31,5	175	6	177,69	7,40	8592667193512

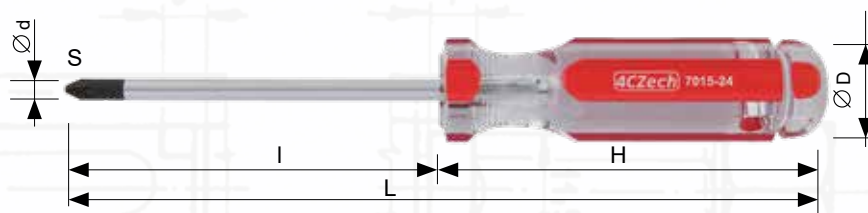

Šroubovák PZ JUMBO
Screwdriver PZ JUMBO
Schraubendreher JUMBO

kód/Code Bestellnummer	S	d (mm)	I (mm)	L (mm)	H (mm)	D (mm)	W (g)		DPC/RRP (Kč/czk)	DPC/RRP (EUR)	EAN13
4CZ-7015-04	PZ0	3,2	100	166	66	16	31	12	64,46	2,69	8592667193390
4CZ-7015-14	PZ1	5	100	189	89	25	73	12	103,31	4,30	8592667193406
4CZ-7015-24	PZ2	6	100	206	106	29	104	12	131,40	5,48	8592667193413



Šroubovák TRX JUMBO
Screwdriver TRX JUMBO
Schraubendreher TRX JUMBO

kód/Code Bestellnummer	S	d (mm)	l (mm)	L (mm)	H (mm)	D (mm)	W (g)		DPC/RRP (Kč/czk)	DPC/RRP (EUR)	EAN13
4CZ-7088-10	T10	5	100	190	90	25	72	12	103,31	4,30	8592667193529
4CZ-7088-15	T15	5	100	190	90	25	73	12	103,31	4,30	8592667193536
4CZ-7088-20	T20	5	100	190	90	25	108	12	103,31	4,30	8592667193543
4CZ-7088-25	T25	6	125	231	106	29	108	12	133,06	5,54	8592667193550
4CZ-7088-27	T27	6	125	231	106	29	115	12	133,06	5,54	8592667193567
4CZ-7088-30	T30	6	150	256	106	29	575	12	133,06	5,54	8592667193574



Bodec na led JUMBO
Ice picker JUMBO
Eisstecher JUMBO

kód/Code Bestellnummer	d (mm)	l (mm)	L (mm)	H (mm)	D (mm)	W (g)		DPC/RRP (Kč/czk)	DPC/RRP (EUR)	EAN13
4CZ-7711-08	8	80	149	63	32	128	6	161,98	6,75	8592667199989
4CZ-7711-12	8	125	231	106	29	53	12	169,42	7,06	8592667199996



Hlubič kuželový (šídlo)
Awl
Ahle

kód/Code Bestellnummer	d (mm)	l (mm)	L (mm)	H (mm)	D (mm)	W (g)		DPC/RRP (Kč/czk)	DPC/RRP (EUR)	EAN13
4CZ-8746-64	6	100	207	106	29	101	12	153,72	6,40	8592667193727



Kozinožka
Tack lifter
Heftheber

kód/Code Bestellnummer	d (mm)	l (mm)	L (mm)	H (mm)	D (mm)	W (g)		DPC/RRP (Kč/czk)	DPC/RRP (EUR)	EAN13
4CZ-8790-20	6	100	206	106	29	101	12	152,89	6,37	8592667193734



Jednopolová zkoušečka napětí
Voltage tester
Spannungsprüfer

kód/Code Bestellnummer	S	B	d (mm)	l (mm)	L (mm)	H (mm)	D (mm)	W (g)		DPC/RRP (Kč/czk)	DPC/RRP (EUR)	EAN13
4CZ-9988-03	SL3,5	1	3,5	80	152	71	16	16	12	48,76	2,03	8592667138872



Šroubovák seřizovací
Adjustable screwdriver
Einstellschraubendreher

kód/Code Bestellnummer	S	B	d (mm)	l (mm)	L (mm)	H (mm)	D (mm)	W (g)		DPC/RRP (Kč/czk)	DPC/RRP (EUR)	EAN13
4CZ-9999-05	SL3,2	0,6	3,2	51	126	75	9,6	9	1	48,76	2,03	8592667200326



Kód / Code / Bestellnummer

4CZ-801, 4CZ-802, 4CZ-808

Industry
line

CrV



HRC
58 / 54



POUŽITÍ

Šroubovák určený pro práci v náročných podmínkách. Dřík šroubováku ze zušlechtěné, vysoce legované oceli s chromovaným povrchem, pracovní část dříku kalena a černěna. Polypropylenová rukojeť odolná vůči oleji a benzínu. Ergonomický tvar rukojeti s prstům přizpůsobených prohlubní rukojeti pro snadnější šroubování, šestihranným průřezem bránícím samovolnému pohybu při odložení a otvorem pro zavěšení nebo použití páky.



USABILITY

Screwdriver designed for work in demanding conditions. The screwdriver shaft is made of refined, high-alloy steel with a chrome-plated surface, the working part of the shaft is hardened and blackened. Polypropylene handle resistant to oil and gasoline. Ergonomic handle with fingers adapted shape for easier screwing, a hexagonal cross-section that prevents spontaneous movement when put away and a hole for hanging or using a lever.



VERWENDUNG

Schraubendreher für den Einsatz unter anspruchsvollen Bedingungen. Schraubendreherschaft aus gehärtetem, hochlegiertem Stahl mit verchromter Oberfläche, Arbeitsteil des Schaftes gehärtet und geschwärzt. Griff aus öl- und benzinbeständigem Polypropylen. Ergonomisch geformter Griff mit Fingermulden zur Erleichterung des Schraubvorgangs, Sechskantprofil zur Verhinderung spontaner Bewegungen beim Herausdrehen und Bohrung zum Aufhängen oder zur Verwendung als Hebel.

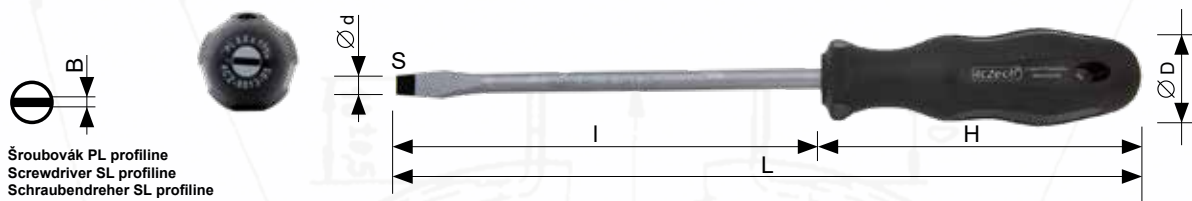

Šroubovák PL profilne
Screwdriver SL profilne
Schraubendreher SL profilne

kód/Code Bestellnummer	S	B (mm)	d (mm)	l (mm)	L (mm)	H (mm)	D (mm)	W (g)		DPC/RRP (Kč/czk)	DPC/RRP (EUR)	EAN13
4CZ-8013-01	SL3	0,5	3	75	147	72	22	27	12	61,16	2,55	8592667192638
4CZ-8013-02	SL4	0,8	4	100	172	72	22	35	12	70,25	2,93	8592667203600
4CZ-8013-03	SL5,5	1	5,5	125	226	101	31	69	12	81,82	3,41	8592667192645
4CZ-8013-04	SL6,5	1,2	6,5	150	260	110	34	99	12	91,74	3,82	8592667192652
4CZ-8013-05	SL8	1,2	8	175	298	123	38	162	6	119,01	4,96	8592667192669

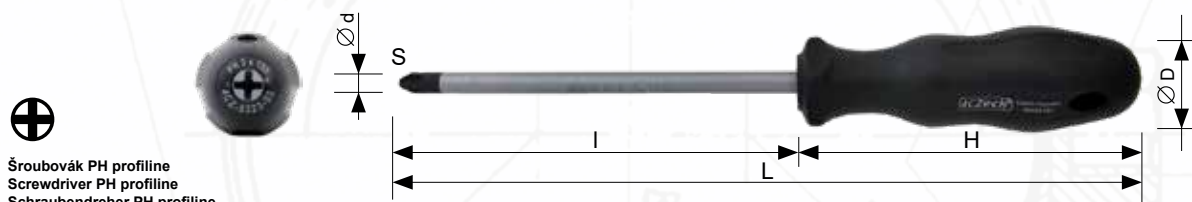

Šroubovák PH profilne
Screwdriver PH profilne
Schraubendreher PH profilne

kód/Code Bestellnummer	S	d (mm)	l (mm)	L (mm)	H (mm)	D (mm)	W (g)		DPC/RRP (Kč/czk)	DPC/RRP (EUR)	EAN13
4CZ-8023-00	PH0	3	60	132	72	22	27	12	58,68	2,44	8592667192713
4CZ-8023-01	PH1	5	80	183	103	31	62	12	73,55	3,06	8592667192720
4CZ-8023-02	PH2	6	100	212	112	34	89	12	90,08	3,75	8592667192737
4CZ-8023-03	PH3	8	150	274	124	38	151	6	119,83	4,99	8592667192744

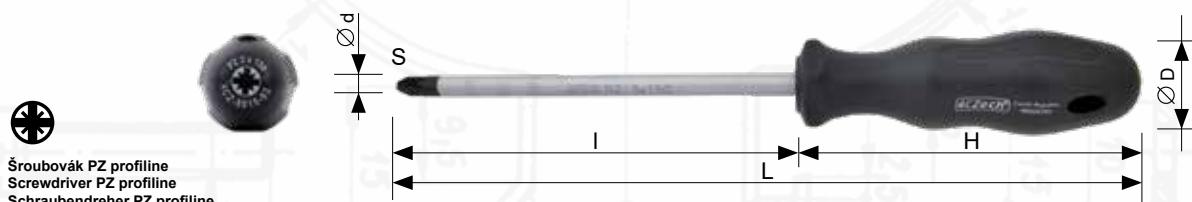

Šroubovák PZ profilne
Screwdriver PZ profilne
Schraubendreher PZ profilne

kód/Code Bestellnummer	S	d (mm)	l (mm)	L (mm)	H (mm)	D (mm)	W (g)		DPC/RRP (Kč/czk)	DPC/RRP (EUR)	EAN13
4CZ-8015-00	PZ0	3	60	132	72	22	26	12	62,81	2,62	8592667192676
4CZ-8015-01	PZ1	5	80	183	103	31	63	12	79,34	3,31	8592667192683
4CZ-8015-02	PZ2	6	100	212	112	34	88	12	97,52	4,06	8592667192690
4CZ-8015-03	PZ3	8	150	274	124	38	151	5	124,79	5,20	8592667192706

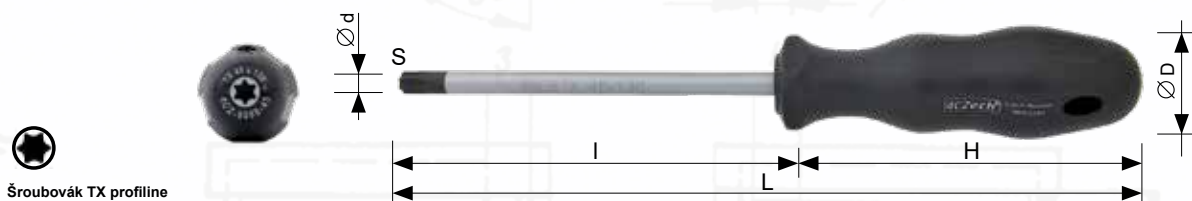

Šroubovák TX profilne
Screwdriver TX profilne
Schraubendreher TX profilne

kód/Code Bestellnummer	S	d (mm)	l (mm)	L (mm)	H (mm)	D (mm)	W (g)		DPC/RRP (Kč/czk)	DPC/RRP (EUR)	EAN13
4CZ-8088-06	T6	4	50	122	72	22	28	12	67,77	2,82	8592667192751
4CZ-8088-08	T8	4	60	132	72	22	30	12	73,55	3,06	8592667192768
4CZ-8088-10	T10	5	80	183	103	31	64	12	73,55	3,06	8592667192775
4CZ-8088-15	T15	5	80	183	103	31	64	12	73,55	3,06	8592667192782
4CZ-8088-20	T20	5	100	203	103	31	66,5	12	78,51	3,27	8592667192799
4CZ-8088-25	T25	6	100	212	112	34	88	12	82,64	3,44	8592667192805
4CZ-8088-30	T30	6	115	227	112	34	92	12	95,87	3,99	8592667192812
4CZ-8088-40	T40	7	130	242	112	34	109	12	114,88	4,79	8592667192829
4CZ-8088-45	T45	8	130	254	124	38	147	6	129,75	5,41	8592667192836



Kód / Code / Bestellnummer

4CZ-831

Industry
line

CrV



HRC
58 / 54



POUŽITÍ

Šroubovák s vysokým kroutícím momentem, určený pro práci v náročných podmínkách. Krátká strana šroubováku se standardním imbusovým klíčem/TORX klíčem a dlouhá strana s imbusem s kuličkou/TORX s otvorem. Dřík šroubováku ze zušlechtné vysoce legované oceli s chromovaným povrchem, pracovní část dříku kalena a černěna. Ergonomická polypropylenová rukojeť ve tvaru L, umožňující vyvinout velký kroutící moment, s otvorem pro zavěšení. Při šroubování kratší stranou, delší strana slouží jako páka pro vyvinutí většího kroutícího momentu. Šroubováky s L-rukojetí jsou řešením při povolování a utahování např. zarezlých nebo lepených šroubů.



USABILITY

Screwdriver with high torque, designed for work in demanding conditions. The short side of the screwdriver with a standard hex/TORX key and the long side with a ball hex/TORX with a hole. Screwdriver shaft made of refined high-alloy steel with a chrome surface, the working part of the shaft is hardened and blackened. Ergonomic polypropylene L-shaped handle, allowing to develop a large torque, with a hole for hanging. When screwing with the shorter side, the longer side serves as a lever to develop a greater torque. Screwdrivers with L-handles are the solution for loosening and tightening, for example, rusted or glued screws.



VERWENDUNG

Schraubendreher mit hohem Drehmoment für den Einsatz in anspruchsvollen Bedingungen. Die kurze Seite des Schraubendrehers mit Standard-Innensechskantschlüssel/TORX-Schlüssel und die lange Seite mit Inbusschlüssel mit Kugel/TORX-Loch. Schraubendreherchaft aus gehärtetem, hochlegiertem und verchromtem Stahl, Arbeitsteil des Schaftes gehärtet und geschwärzt. Ergonomischer L-förmiger Polypropylen-Griff für hohe Drehmomente, mit Loch zum Aufhängen. Beim Schrauben mit der kürzeren Seite dient die längere Seite als Hebel, um mehr Drehmoment zu entwickeln. L-Griff-Schraubendreher sind die Lösung für das Lösen und Anziehen von z.B. verrosteten oder verklebten Schrauben.



Šroubovák L rukojeť 6HR s kuličkou profiline
Screwdriver L-handle HEX with a ball profiline
Schraubendreher L Handgriff 6-kant mit Kugelkopf profiline

kód/Code Bestellnummer	S	S1	d (mm)	l (mm)	L (mm)	H (mm)	l1 (mm)	L1	H1	B	W (g)		DPC/RRP (Kč/cz)	DPC/RRP (EUR)	EAN13
4CZ-8314-01	HB2	H2	2,5	110	141	31	16	70	54	17	25	6	81,82	3,41	8592667192461
4CZ-8314-02	HB2,5	H2,5	3	110	141	31	16	70	54	17	27	6	85,12	3,55	8592667192478
4CZ-8314-03	HB3	H3	3,5	110	141	31	16	70	54	17	30	6	95,87	3,99	8592667192485
4CZ-8314-04	HB4	H4	5	110	141	31	16	70	54	17	44	6	118,18	4,92	8592667192492
4CZ-8314-05	HB5	H5	6	160	205	45	19	95	76	24	93	6	134,71	5,61	8592667192508
4CZ-8314-06	HB6	H6	7	160	205	45	19	95	76	24	112	6	144,63	6,03	8592667192515
4CZ-8314-08	HB8	H8	9,5	200	245	45	19	95	76	24	193	6	178,51	7,44	8592667192522
4CZ-8314-10	HB10	H10	12	215	270	55	20	121	101	30	352	6	220,66	9,19	8592667192539

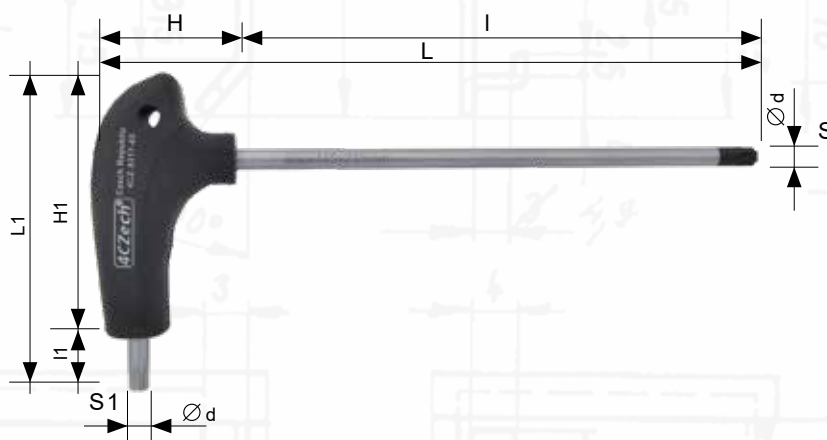

Šroubovák L rukojeť TX profiline
Screwdriver L-handle TX profiline
Schraubendreher L Handgriff TX profiline

kód/Code Bestellnummer	S	S1	d (mm)	l (mm)	L (mm)	H (mm)	l1 (mm)	L1	H1	B	W (g)		DPC/RRP (Kč/cz)	DPC/RRP (EUR)	EAN13
4CZ-8317-09	TT9	T9	4	110	141	31	16	70	54	17	36	6	152,89	6,37	8592667192546
4CZ-8317-10	TT10	T10	4	110	141	31	16	70	54	17	36	6	152,89	6,37	8592667192553
4CZ-8317-15	TT15	T15	4	110	141	31	16	70	54	17	36	6	152,89	6,37	8592667192560
4CZ-8317-20	TT20	T20	4	110	141	31	16	70	54	17	36	6	153,72	6,40	8592667192577
4CZ-8317-25	TT25	T25	6	160	205	45	19	95	76	24	94	6	156,20	6,51	8592667192584
4CZ-8317-27	TT27	T27	6	160	205	45	19	95	76	24	93	6	189,26	7,89	8592667192591
4CZ-8317-30	TT30	T30	6	160	205	45	19	95	76	24	94	6	209,92	8,75	8592667192607
4CZ-8317-40	TT40	T40	7	185	230	45	19	95	76	24	117	6	239,67	9,99	8592667192614
4CZ-8317-45	TT45	T45	8	215	270	55	21	122	101	30	200	6	254,55	10,61	8592667192621



Kód / Code / Bestellnummer

4CZ-28, 4CZ-18

Industry
line

**DIN
1041**

**DIN
1042**

**ISO
15601**



POUŽITÍ

Kladiva zámečnická, kladiva předtloukací. Hlava kladiva zápusťkově kovaná a broušená na přesné rozměry. Pečlivě kalená a popouštěná. Hlava lakovaná, ploška a nos lesklé. Materiál: Speciální nástrojová ocel.



USABILITY

Hammers, sledgehammers. Hammer head drop forged and ground to size. Carefully hardened and tempered. Head painted, face and peen bright finished. Material: Special tool steel.



VERWENDUNG

Hammer, Fausthammer. Hammerkopf im Gesenk geschmiedet und maßgenau geschliffen. Sorgfältig gehärtet und angelassen. Kopf lackiert, Bahn und Pinne blank. Werkstoff: Spezial-Werkzeugstahl.

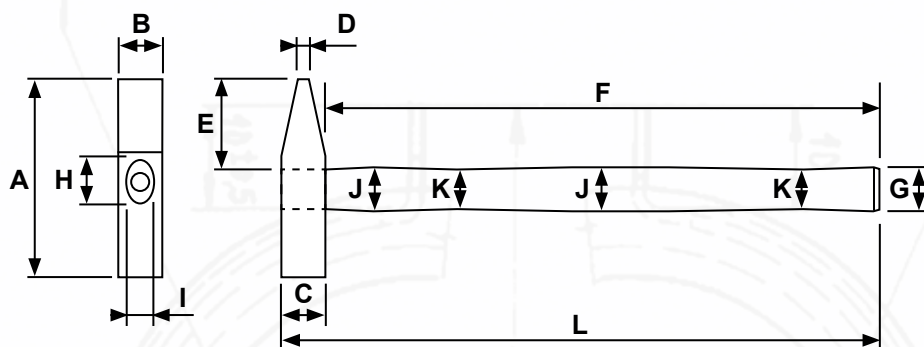

DIN 1041
ISO 15601

Kladivo zámečnické Hammer Hammer

kód/Code Bestellnummer	A (mm)	B (mm)	C (mm)	D (mm)	E (mm)	F (mm)	G (mm)	H (mm)	I (mm)	J (mm)	K (mm)	L (mm)	W (g)		DPC/RRP (Kč/czk)	DPC/RRP (EUR)	EAN13
4CZ-28-0100	81	10	10	4	31	242	24	18	11	23	18	252	183	1	241,32	10,06	8592667161818
4CZ-28-0200	94	20	20	4	35	257	27	21	13	25	22	277	284	1	250,41	10,43	8592667161849
4CZ-28-0300	104	24	24	5	43	273	33	22	13	30	27	297	430	1	273,55	11,40	8592667161863
4CZ-28-0400	110	26	26	5	43	290	34	24	14	31	27	316	499	1	292,56	12,19	8592667161870
4CZ-28-0500	118	28	28	5	45	290	36	27	17	34	30	318	619	1	308,26	12,84	8592667161887
4CZ-28-0600	120	30	30	5	48	298	36	29	17	34	30	328	740	1	322,31	13,43	8592667161894
4CZ-28-0800	130	33	33	5	49	312	38	30	19	35	32	345	1041	1	407,44	16,98	8592667161900
4CZ-28-1000	135	33	33	7	53	320	41	32	20	39	34	353	1147	1	503,31	20,97	8592667161825
4CZ-28-1500	145	43	43	8	58	332	43	34	21	40	35	375	1704	1	616,53	25,69	8592667161832
4CZ-28-2000	153	48	48	10	61	347	47	40	24	44	42	395	2274	1	716,53	29,86	8592667161856

DIN 1042
ISO 15601

Kladivo předtloukací Sledgehammer Vorschlaghammer

kód/Code Bestellnummer	A (mm)	B (mm)	C (mm)	D (mm)	E (mm)	F (mm)	G (mm)	H (mm)	I (mm)	J (mm)	K (mm)	L (mm)	W (g)		DPC/RRP (Kč/czk)	DPC/RRP (EUR)	EAN13
4CZ-18-3000	160	58	58	10	58	542	40	43	26	50	43	600	3311	1	969,42	40,39	8592667161917
4CZ-18-4000	174	64	64	12	64	637	43	43	26	50	44	701	4582	1	1093,39	45,56	8592667161924
4CZ-18-5000	185	70	70	12	70	731	45	50	30	55	45	801	5584	1	1340,50	55,85	8592667161931





Kód / Code / Bestellnummer

4CZ-51, 4CZ-52

Industry
line



POUŽITÍ

Tesařské kladivo pro použití na stavbách a při opravách dřevěných konstrukcí. Díky magnetu v zatlukací hlavě není nutné hřebíky přidržovat, ale lze je zatlučet jednou rukou. Nos kladiva přizpůsobený pro vyťahování hřebíků.



USABILITY

Carpenter's hammer made for use on construction sites and during repairing of wooden structures. Thanks to the magnet in the hammering head, it is not necessary to hold the nails, but they can be hammered with one hand. Hammer nose is adapted for pulling out nails.



VERWENDUNG

Zimmermannshammer für den Einsatz auf Baustellen und bei der Reparatur von Holzkonstruktionen. Dank des Magneten im Hammerkopf müssen die Nägel nicht festgehalten werden, sondern können mit einer Hand eingeschlagen werden. Die Spitze des Hammers ist für das Herausziehen von Nägeln geeignet.

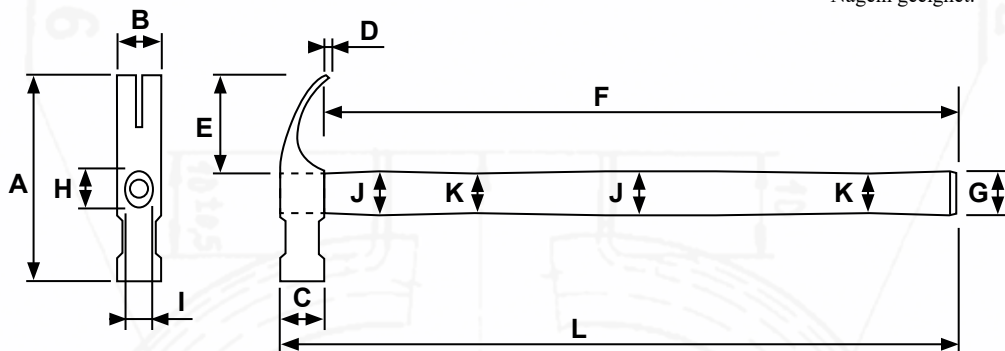

Kladivo tesařské se zahnutými čelistmi
Carpenter's hammer with curved jaws
Zimmermannshammer mit gebogenen Backen

kód/Code Bestellnummer	A (mm)	B (mm)	C (mm)	D (mm)	E (mm)	F (mm)	G (mm)	H (mm)	I (mm)	J (mm)	K (mm)	L (mm)	W (g)	Rukojet/Handle/Griff	DPC/RRP (Kč/czk)	DPC/RRP (EUR)	EAN13
4CZ-51-450	130	37	30	5	46	292	40	29	17	37,5	32,5	340	720	dřevo, wood, Holz	1 459,50	19,15	8592667200012
4CZ-52-450	130	36	30	5	47	282	41	29	18	33	30	330	720	plast, plastic, Kunststoff	1 322,31	13,43	8592667200036



Magnet
Magnet
Magnet

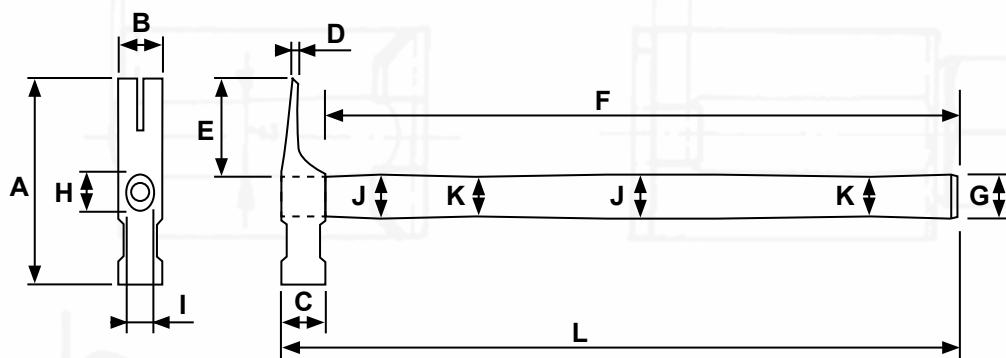

Kladivo tesařské s rovnými čelistmi
Carpenter's hammer with straight jaws
Zimmermannshammer mit geraden Backen

kód/Code Bestellnummer	A (mm)	B (mm)	C (mm)	D (mm)	E (mm)	F (mm)	G (mm)	H (mm)	I (mm)	J (mm)	K (mm)	L (mm)	W (g)	Rukojeť/Handle/Griff	DPC/RRP (Kč/czk)	DPC/RRP (EUR)	EAN13
4CZ-51-560	147	35	32	6	59	295	36	30	17	36	31	350	840	dřevo, wood, Holz	1 414,88	17,29	8592667200029
4CZ-52-560	147	36	32	6	60	282	41	30	17	33	30	336	840	plast, plastic, Kunststoff	1 335,54	13,98	8592667200043



Magnet
Magnet
Magnet



Kód / Code / Bestellnummer

4CZ-56

Industry
line



POUŽITÍ

Kovaná ocelová sekera s hybridním tvarem hlavy pro snadné štípání a sekání. Čelní výřezy usnadňují snadné vyjmutí ze dřeva. Plastová texturovaná rukojeť poskytuje pohodlné a bezpečné uchopení během používání, tlumí nárazy a zabraňuje sklouznutí. Tato ocelová sekera je skvělou volbou pro štípání malých polen kolem vašeho domova a pro rekreační použití při kempování. Součástí sekery je ochranný kryt.



USABILITY

Forged steel axe with a hybrid head shape for easy splitting and chopping. Front cutouts make easier removal from the wood. The plastic textured handle provides a comfortable and secure grip during use, absorbs shock and prevents slipping. This steel axe is a great choice for chopping small logs around your home and for recreational camping use. The axe is supplied with a protective cover.



VERWENDUNG

Geschmiedete Stahlaxt mit hybrider Kopfform für einfaches Spalten und Hacken. Vordere Aussparungen erleichtern die Entnahme aus dem Holz. Der strukturierte Kunststoffgriff bietet einen bequemen und sicheren Griff während der Benutzung, absorbiert Stöße und verhindert ein Abrutschen. Diese Stahlaxt eignet sich hervorragend zum Spalten kleinerer Stämme zu Hause und für den Freizeitgebrauch beim Camping. Die Axt wird mit einer Schutzhülle geliefert.

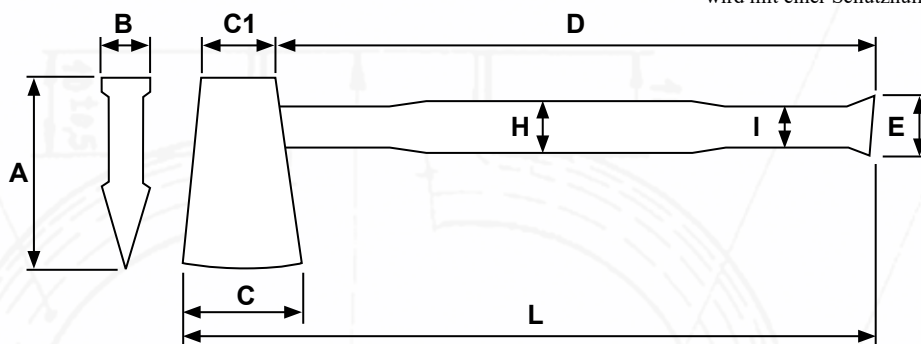

Sekera 350mm s plastovou rukojetí
Camp axe 350mm, plastic handle
Axt 350mm mit Kunststoffgriff

kód/Code Bestellnummer	A (mm)	B (mm)	C (mm)	C1 (mm)	D (mm)	E (mm)	H (mm)	I (mm)	L (mm)	W (g)	DPC/RRP (Kč/czk)	DPC/RRP (EUR)	EAN13	
4CZ-56-350	130,0	21,0	73,0	40	300	47	39	35	355	1020	1	524,79	21,87	8592667200098





Kód / Code / Bestellnummer

4CZ-603, 4CZ-603P, 4CZ-53, 4CZ-54, 4CZ-55

Industry
line



POUŽITÍ

Palice s dřevěnou, ergonomicky tvarovanou, lakovanou násadou s kruhovým klínem nebo s plastovou násadou. Oboustranná kovaná hlava se zaoblenými hranami kolem pracovní plochy oddaluje vznik ořepů a snižují nebezpečí odlétnutí špony. K použití například pro demoliční účely, nebo lámání kamene. Na zarážení kůlů, rozbíjení betonových nebo cihlových bloků, s použitím klínů na štípání dřeva atd. V nabídce i bezodskokové paličky a palička s měkkými konci.



USABILITY

Mallet with a wooden, ergonomically shaped, lacquered handle with a circular wedge or with a plastic handle. The double-sided forged head with rounded edges around the work surface postpones the formation of burrs and reduces the risk of chip flying. It is used, for example, for demolition purposes or breaking stone. For driving stakes, breaking concrete or brick blocks, splitting wood with wedges, etc. Anti-rebound mallets and mallets with soft ends are also available.



VERWENDUNG

Fäustel mit ergonomisch geformtem, lackiertem Holzgriff mit Rundkeil oder Kunststoffgriff. Der beidseitig geschmiedete Kopf mit abgerundeten Kanten rund um die Arbeitsfläche verzögert die Gratbildung und verringert das Risiko, dass sich der Spike löst. Einsetzbar z. B. für Abbrucharbeiten oder zum Brechen von Steinen. Zum Eintreiben von Pfählen, zum Brechen von Beton- oder Ziegelsteinen, zum Spalten von Holz mit Keilen usw. Auch mit splitterfreien Schlägeln und Schlägern mit weichem Ende erhältlich.

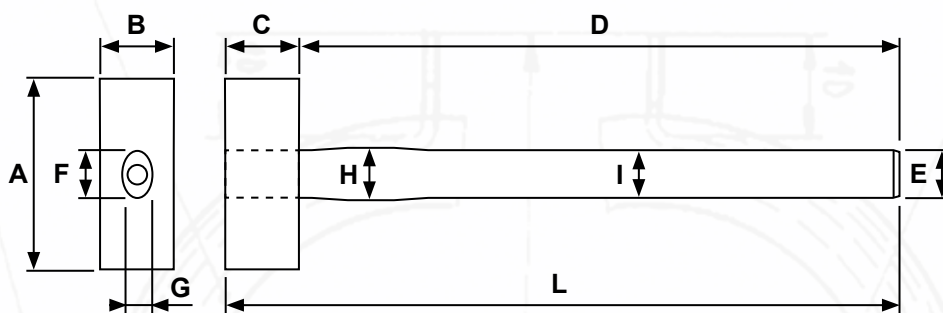

Palice
Mallet
Fäustel

kód/Code Bestellnummer	A (mm)	B (mm)	C (mm)	D (mm)	E (mm)	F (mm)	G (mm)	H (mm)	I (mm)	L (mm)	W (g)	DPC/RRP (Kč/czk)	DPC/RRP (EUR)	EAN13	
4CZ-603-1500	105	46	46	232	44	35	21	40	38	280	1660	1	616,53	25,69	8592667161948
4CZ-603-2000	118	51	51	248	45	38	24	42	39	299	2250	1	736,36	30,68	8592667161955
4CZ-603-3000	139	59	59	541	42	44	27	50	44	600	3651	1	969,42	40,39	8592667161962
4CZ-603-5000	155	70	70	730	44	50	30	53	45	800	5527	1	1504,13	62,67	8592667161979
4CZ-603-6000	164	73	73	730	44	50	30	53	45	803	6640	1	1699,17	70,80	8592667161986





Snižení styčné plochy pro větší koncentraci síly úderu.
Lowering of the contact area for greater concentration of impact force.
Reduzierung der Kontaktfläche für stärkere Konzentration der Schlagkraft

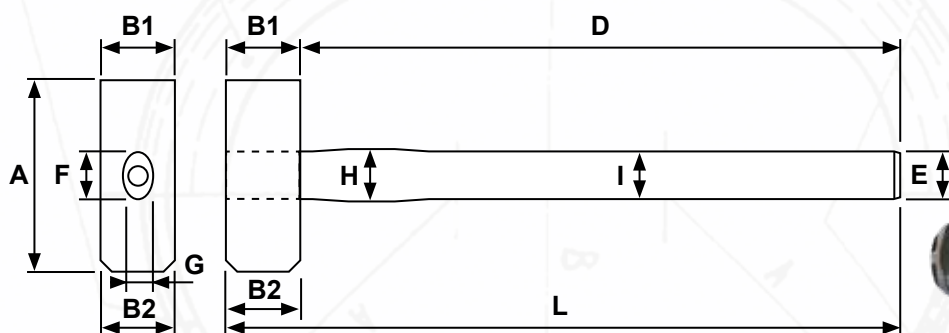

Palice se sklolaminátovou násadou
Mallet with fiberglass handle
Fäustel mit Glasfaserstiel

Kód/Code Bestellnummer	A (mm)	B1 (mm)	B2 (mm)	D (mm)	E (mm)	F (mm)	G (mm)	H (mm)	I (mm)	L (mm)	W (g)		DPC/RRP (Kč/czk)	DPC/RRP (EUR)	EAN13
4CZ-603P-1300	104	49,5	49,5	251	38	32	24	39,5	32,5	302	1580	1	628,10	26,17	8592667191952
4CZ-603P-1800	135	49,2	48,5	333	38	32	25,5	40	32	384	2200	1	792,56	33,02	8592667191969
4CZ-603P-3600	165	58,5	58,5	826	53	39	30	57	41,5	887	5000	1	1761,16	73,38	8592667191976



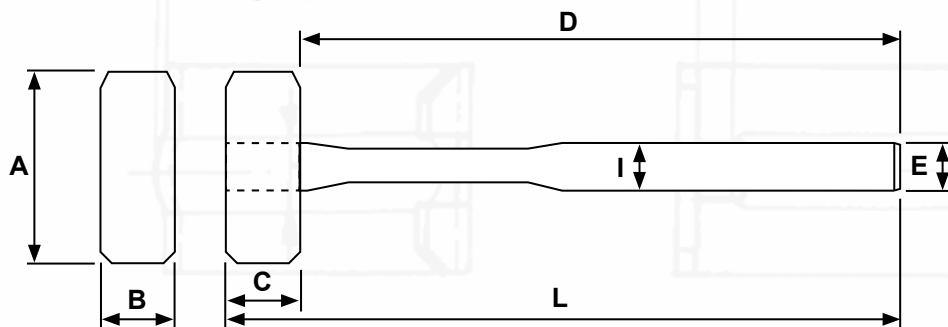

Palička s plastovou rukojetí
Mallet with plastic handle
Fäustel mit Kunststoffgriff

kód/Code Bestellnummer	A (mm)	B (mm)	C (mm)	D (mm)	E (mm)	I (mm)	L (mm)	W (g)	DPC/RRP (Kč/czk)	DPC/RRP (EUR)	EAN13	
4CZ-53-1200	90	35	38	230	36	29	280	1200	1	566,12	23,59	8592667200050

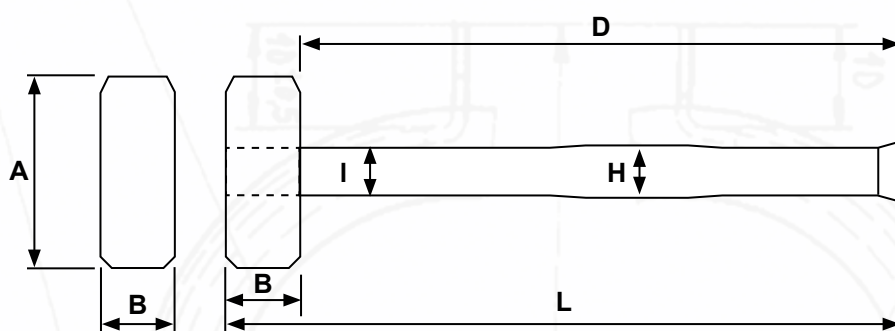

Palička bezodskoková s plastovou rukojetí
Dead blow hammer with plastic handle
Schonhammer, rückschlagfrei mit Kunststoffgriff

kód/Code Bestellnummer	A (mm)	B (mm)	D (mm)	H (mm)	I (mm)	L (mm)	W (g)	DPC/RRP (Kč/czk)	DPC/RRP (EUR)	EAN13	
4CZ-54-0800	100	50	270	39	34	325	700	1	338,02	14,08	8592667200067
4CZ-54-1200	119	59	300	42	38	367	1220	1	433,06	18,04	8592667200074

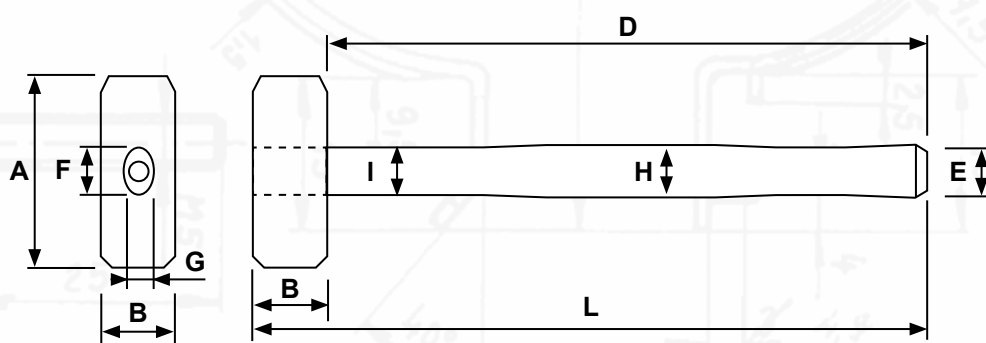

Palička s měkkými konci s dřevěnou rukojetí
Double face soft hammer with wooden handle
Schonhammer, rückschlagfrei, mit weichen Enden mit Holzgriff

kód/Code Bestellnummer	A (mm)	B (mm)	D (mm)	E (mm)	F (mm)	G (mm)	H (mm)	I (mm)	L (mm)	W (g)	DPC/RRP (Kč/czk)	DPC/RRP (EUR)	EAN13	
4CZ-55-350	121	38,8	292	39,3	29	18	35	33	325	660	1	242,98	10,12	8592667200081





Kód / Code / Bestellnummer

4CZ-60, 4CZ-64

Industry line



POUŽITÍ

Páčidlo s vyťahovačem hřebíků je vyrobené z oceli odolné proti deformacím. Běžně se používá k otevírání dřevěných beden, odstraňování hřebíků nebo jako páka k oddělování předmětů. Je to i nepostradatelný pomocník pro rekonstrukce při stavebních pracích. Svě uplatnění najde při bourání podlahy, soklových lišt a poslouží i k vypáčení či vybourání stěn.



USABILITY

The pry bar with the nail puller is made of deformation-resistant steel. It is commonly used to open wooden crates, remove nails or as a lever to separate objects. It is also an indispensable helper for reconstruction during construction work. It finds its application when demolishing the floor, plinths and is also used for prying out or demolishing walls.



VERWENDUNG

Das Brecheisen ist aus verformungsbeständigem Stahl gefertigt. Es wird üblicherweise zum Öffnen von Holzkisten, zum Entfernen von Nägeln oder als Hebel zum Trennen von Gegenständen verwendet. Es ist auch ein unentbehrlicher Helfer bei Renovierungsarbeiten während der Bauarbeiten. Es kann zum Abbruch von Fußböden, Sockelleisten und auch zum Aufstemmen oder Herausbrechen von Wänden verwendet werden.

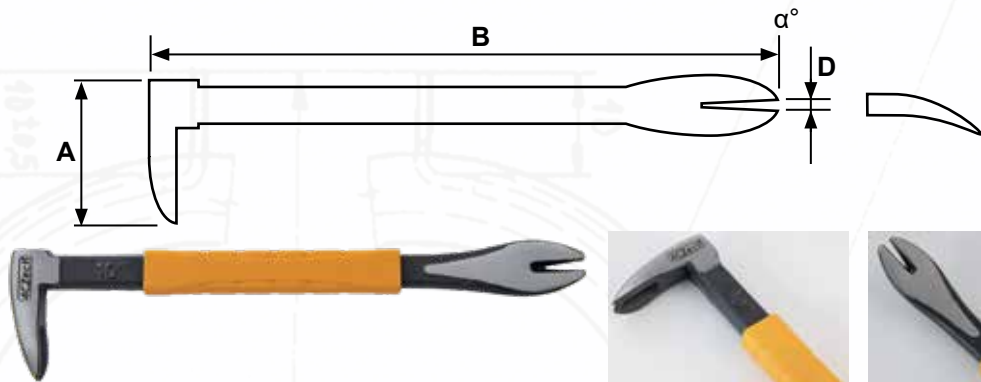

Páčidlo přesné
Claw bar
Krallenstange

kód/Code Bestellnummer	A (mm)	B (mm)	C (mm)	D (mm)	F (mm)	H (mm)	α°	L (mm)	W (g)		DPC/RRP (Kč/czk)	DPC/RRP (EUR)	EAN13
4CZ-60-250	18	5	24	4	59	14 x 19	20	250	300	1	225,62	9,40	8592667200104

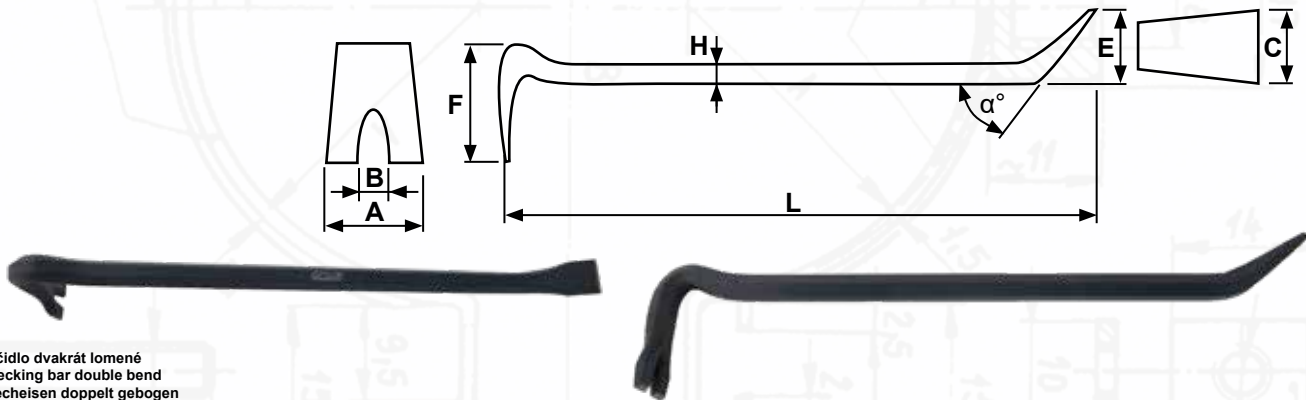

Páčidlo dvakrát lomené
Wrecking bar double bend
Brecheisen doppelt gebogen

kód/Code Bestellnummer	A (mm)	B (mm)	C (mm)	F (mm)	H (mm)	α°	L (mm)	W (g)		DPC/RRP (Kč/czk)	DPC/RRP (EUR)	EAN13
4CZ-64-0600	40	8	30	105	20	40	600	1580	1	247,93	10,33	8592667200173
4CZ-64-0800	40	9	30	105	20	40	800	2080	1	321,49	13,40	8592667200180
4CZ-65-0600	43	10	37	125	22	40	600	2240	1	316,53	13,19	8592667200197
4CZ-65-0800	43	10	37	125	22	40	800	2820	1	413,22	17,22	8592667200203
4CZ-65-0900	43	10	37	120	22	40	900	3160	1	421,49	17,56	8592667200210
4CZ-65-1000	43	10	38	120	22	40	1000	3460	1	479,34	19,97	8592667200227
4CZ-65-1250	43	10	38	120	22	40	1250	4320	1	588,43	24,52	8592667200234
4CZ-65-1500	43	10	38	120	22	40	1500	5180	1	710,74	29,61	8592667200241



Sada páčidel s plastovou rukojetí 4-dílná, 200mm-300mm-450mm-600mm
Pry bar 4 pcs set with plastic handle, 200mm-300mm-450mm-600mm
Brechstangen-Set mit Kunststoffgriff, 4-teilig, 200mm-300mm-450mm-600mm

kód/Code Bestellnummer	W (g)		DPC/RRP (Kč/czk)	DPC/RRP (EUR)	EAN13
4CZ-66-s4	1400	1	459,50	19,15	8592667200258

obsah / content / Inhalt	velikost / size / Größe
páčidlo / Pry bar / Brechstangen	10x200 - 16x300 - 20x450 - 20x600mm



Kód / Code / Bestellnummer

4CZ-63, 4CZ-62

Industry
line



POUŽITÍ

Sekáč zámečnický, plochý se šestihlanným profilem. Používá se k dělení ocelových profilů a tyčí, odstraňování nýtovaných a šroubovaných spojů a k dělení plechu, který je příliš silný nebo se obtížně stříhá nůžkami na plech.



USABILITY

Locksmith's chisel, flat with hexagonal profile. It is used for cutting steel profiles and bars, removing riveted and bolted joints, and cutting sheet metal that is too thick or difficult to cut with sheet metal shears.



VERWENDUNG

Schlossermeißel, flach mit Sechskantprofil. Zum Schneiden von Stahlprofilen und -stäben, zum Entfernen von Niet- und Schraubverbindungen und zum Schneiden von Blechen, die zu dick sind oder sich nur schwer mit einer Blechscher schneiden lassen.

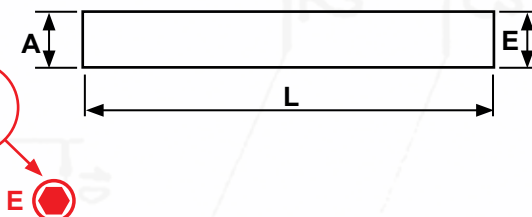

Sekáč plochý
Flat chisel
Flachmeißel

kód/Code Bestellnummer	A (mm)	E (mm)	L (mm)	W (g)		DPC/RRP (Kč/czk)	DPC/RRP (EUR)	EAN13
4CZ-63-150	16,5	12,7	150	160	1	61,16	2,55	8592667200135
4CZ-63-200	21,7	19,4	200	460	1	71,07	2,96	8592667200142
4CZ-63-250	22,3	19,4	250	580	1	85,12	3,55	8592667200159
4CZ-63-300	22,3	19,4	300	700	1	111,57	4,65	8592667200166

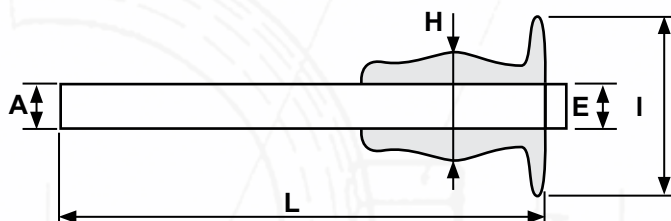

Sekáč plochý s chráničem
Flat chisel with bi-material grip
Flachmeißel mit Handschutz

kód/Code Bestellnummer	A (mm)	E (mm)	H (mm)	I (mm)	L (mm)	W (g)		DPC/RRP (Kč/czk)	DPC/RRP (EUR)	EAN13
4CZ-62-200	21,7	19,4	39	99	200	620	1	146,28	6,10	8592667200111
4CZ-62-300	22,3	19,4	39	99	300	860	1	181,82	7,58	8592667200128

Sada sekáčů, průbojníků a důlčků, 12-dílná, 6HR, CrV

Chisel & punch 12 pcs set, Hex, CrV

Meißel- und Durchschlagsatz, 12-teilig 6-kant, CrV

kód/Code Bestellnummer	W (g)		DPC/RRP (Kč/czk)	DPC/RRP (EUR)	EAN13
4CZ-67-12	1000	1	790,08	32,92	8592667200265

obsah / content / Inhalt	velikost / size / Größe
důlkovač / center punch / Körner	6 - 8mm
sekáč plochý / Cold chisel / Meißel flach	10 - 12 - 16mm
průbojník kuželový / punch conical / Locher konisch	2mm
průbojník válcový / punch cylindrical / Locher zylindrisch	1,5 - 3 - 4 - 5 - 6 - 8mm





Kód / Code / Bestellnummer

4CZ-211

Industry
line

**DIN
7261**

**HRC
61**



POUŽITÍ

Pilníky s plastovou rukojetí. Pro běžné potřeby pilování v domácnostech, zámečnických dílnách, výrobě atd. Mají křížový sek. Tvar a hrubost pilníku závisí na typu práce a požadovaném výsledku. Obecně platí, čím hrubší sek, tím větší úběr materiálu. Pro hladší povrch by se měl volit pilník s jemnějším sekem. Čepel je vyrobeny z nástrojové, tepelně zpracované oceli na tvrdost 61 HRC (normou požadovaná tvrdost je 59 HRC).



USABILITY

The files with plastic handle. Used for filing in households, workshops, etc. They are cross cut. A shape and roughness of file depend on a type of work and on required final result. Basically, the rougher the cut, the greater the effect. For a smooth surface a file with a fine cut should be used. The blades are made of tool steel, heat-treated to a hardness of 61 HRC (the standard hardness is 59 HRC).



VERWENDUNG

Feile mit Kunststoffgriff. Für Verwendung im Haushalt, Schlossereien, in der Produktion usw. Kreuzhieb. Die Form und Grobheit der Feile ist abhängig: von der Arbeitstechnologie und dem gewünschten Ergebnis. Im Allgemeinen, je grösser der Hieb, um so grösser ist die Spanabhebung. Für glatte Oberfläche sollte eine Feile mit feinen Hieb verwendet werden. Die Klingen sind aus Werkzeugstahl, wärmebehandelt auf eine Härte von 61 HRC (die von der Norm geforderte Härte beträgt 59 HRC).

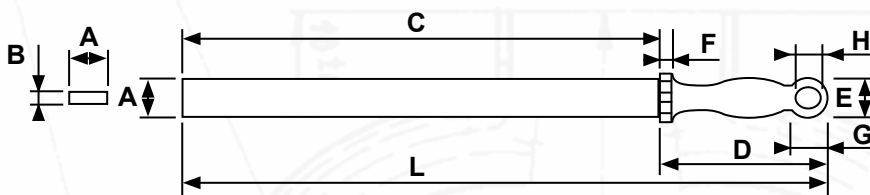

Pilník plochý lehký - tvar PLO
File hand thin - shape PLO
Feile flachstumpf - Form PLO

X Číslo seku
Cut number
Hiebnummer



kód/Code Bestellnummer	A (mm)	B (mm)	C (mm)	D (mm)	E (mm)	F (mm)	G (mm)	H (mm)	L (mm)	X	W (g)	DPC/RRP (Kč/czsk)	DPC/RRP (EUR)	EAN13	
4CZ-21110-1515	16	3	150	80	22	8	18	13x11	230	1	96	5	127,27	5,30	8592667676961
4CZ-21110-1525	16	3	150	80	22	8	18	13x11	230	2	98	5	131,40	5,48	8592667161542
4CZ-21110-1535	16	3	150	80	22	8	18	13x11	230	3	96	5	143,80	5,99	8592667676978
4CZ-21110-2015	20	3	200	110	30	8	28	18x14	310	1	154	5	153,72	6,40	8592667676985
4CZ-21110-2025	20	3	200	110	30	8	28	18x14	310	2	154	5	165,29	6,89	8592667161559
4CZ-21110-2035	20	3	200	110	30	8	28	18x14	310	3	150	5	178,51	7,44	8592667676992
4CZ-21110-2515	25	4,5	250	110	30	8	28	18x14	360	1	297	5	215,70	8,99	8592667677005
4CZ-21110-2525	25	4,5	250	110	30	8	28	18x14	360	2	287	5	225,62	9,40	8592667161566
4CZ-21110-2535	25	4,5	250	110	30	8	28	18x14	360	3	292	5	235,54	9,81	8592667677012
4CZ-21110-3015	30	4,5	300	110	30	8	28	18x14	410	1	446	5	288,43	12,02	8592667677029
4CZ-21110-3025	30	4,5	300	110	30	8	28	18x14	410	2	428	5	298,35	12,43	8592667161573
4CZ-21110-3035	30	4,5	300	110	30	8	28	18x14	410	3	477	5	316,53	13,19	8592667677036

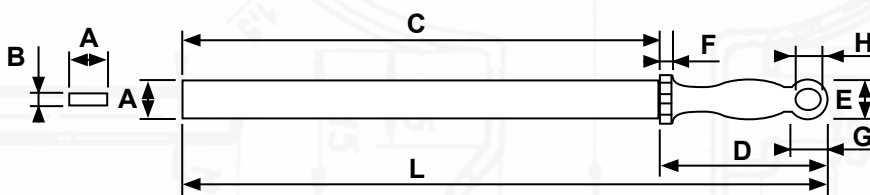

Pilník plochý silný - tvar PSO
File hand - shape PSO
Feile flachstumpf - Form PSO

X Číslo seku
Cut number
Hiebnummer



kód/Code Bestellnummer	A (mm)	B (mm)	C (mm)	D (mm)	E (mm)	F (mm)	G (mm)	H (mm)	L (mm)	X	W (g)	DPC/RRP (Kč/czsk)	DPC/RRP (EUR)	EAN13	
4CZ-21121-1015	12	2,5	100	80	22	8	18	13x11	230	1	48	5	101,65	4,24	8592667677043
4CZ-21121-1025	12	2,5	100	80	22	8	18	13x11	230	2	48	5	109,09	4,55	8592667677050
4CZ-21121-1035	12	2,5	100	80	22	8	18	13x11	230	3	49	5	114,05	4,75	8592667677067
4CZ-21121-1515	16	4	150	80	22	8	18	13x11	230	1	113	5	134,71	5,61	8592667677074
4CZ-21121-1525	16	4	150	80	22	8	18	13x11	230	2	107	5	139,67	5,82	8592667161580
4CZ-21121-1535	16	4	150	80	22	8	18	13x11	230	3	116	5	147,11	6,13	8592667677081
4CZ-21121-2015	20	5	200	110	30	8	28	18x14	310	1	188	5	194,21	8,09	8592667677098
4CZ-21121-2025	20	5	200	110	30	8	28	18x14	310	2	188	5	199,17	8,30	8592667161597
4CZ-21121-2035	20	5	200	110	30	8	28	18x14	310	3	202	5	213,22	8,88	8592667677104
4CZ-21121-2515	25	6	250	110	30	8	28	18x14	360	1	359	5	230,58	9,61	8592667677111
4CZ-21121-2525	25	6	250	110	30	8	28	18x14	360	2	348	5	242,15	10,09	8592667161603
4CZ-21121-2535	25	6	250	110	30	8	28	18x14	360	3	361	5	258,68	10,78	8592667677128
4CZ-21121-3015	30	7	300	110	30	8	28	18x14	410	1	515	5	260,33	10,85	8592667677135
4CZ-21121-3025	30	7	300	110	30	8	28	18x14	410	2	511	5	269,42	11,23	8592667161610
4CZ-21121-3035	30	7	300	110	30	8	28	18x14	410	3	511	5	288,43	12,02	8592667677142
4CZ-21121-3515	36	8	350	134	38	14	30	20x16	484	1	773	5	307,44	12,81	8592667677159
4CZ-21121-3525	36	8	350	134	38	14	30	20x16	484	2	778	5	323,14	13,46	8592667161627
4CZ-21121-3535	36	8	350	134	38	14	30	20x16	484	3	795	5	325,62	13,57	8592667677166

Pilníky jsou dodávány se závěsným držákem. The files are supplied with a hanger. Die Feile werden mit einem Hängehalter geliefert.

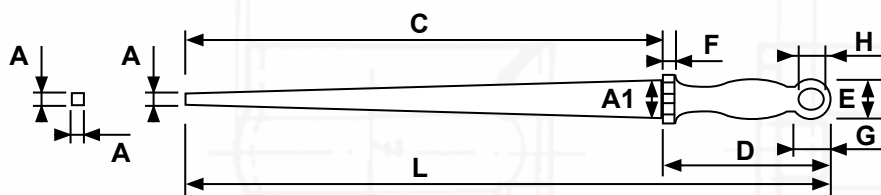

Pilník čtyřhranný - tvar PZC
File square - shape PZC
Feile vierkant - Form PZC

X Číslo seku
Cut number
Hiebnummer



kód/Code Bestellnummer	A (mm)	A1 (mm)	C (mm)	D (mm)	E (mm)	F (mm)	G (mm)	H (mm)	L (mm)	X	W (g)		DPC/RRP (Kč/czk)	DPC/RRP (EUR)	EAN13
4CZ-21145-1015	2,8	4	100	80	22	8	18	13x11	230	1	33	5	92,56	3,86	8592667677173
4CZ-21145-1025	2,8	4	100	80	22	8	18	13x11	230	2	33	5	99,17	4,13	8592667677180
4CZ-21145-1035	2,8	4	100	80	22	8	18	13x11	230	3	31	5	106,61	4,44	8592667677197
4CZ-21145-1515	4	6	150	80	22	8	18	13x11	230	1	75	5	116,53	4,86	8592667677203
4CZ-21145-1525	4	6	150	80	22	8	18	13x11	230	2	59	5	125,62	5,23	8592667161634
4CZ-21145-1535	4	6	150	80	22	8	18	13x11	230	3	80	5	143,80	5,99	8592667677210
4CZ-21145-2015	5	8	200	110	30	8	28	18x14	310	1	130	5	145,45	6,06	8592667677227
4CZ-21145-2025	5	8	200	110	30	8	28	18x14	310	2	127	5	153,72	6,40	8592667161641
4CZ-21145-2035	5	8	200	110	30	8	28	18x14	310	3	126	5	175,21	7,30	8592667677234
4CZ-21145-2515	6	10	250	110	30	8	28	18x14	360	1	225	5	199,17	8,30	8592667677241
4CZ-21145-2525	6	10	250	110	30	8	28	18x14	360	2	230	5	209,09	8,71	8592667161658
4CZ-21145-2535	6	10	250	110	30	8	28	18x14	360	3	225	5	230,58	9,61	8592667677258
4CZ-21145-3015	8	12	300	110	30	8	28	18x14	410	1	388	5	264,46	11,02	8592667677265
4CZ-21145-3025	8	12	300	110	30	8	28	18x14	410	2	355	5	275,21	11,47	8592667161665
4CZ-21145-3035	8	12	300	110	30	8	28	18x14	410	3	366	5	298,35	12,43	8592667677272
4CZ-21145-3515	9	14	350	134	38	14	30	20x16	484	1	685	5	344,63	14,36	8592667677289
4CZ-21145-3525	9	14	350	134	38	14	30	20x16	484	2	623	5	367,77	15,32	8592667161672
4CZ-21145-3535	9	14	350	134	38	14	30	20x16	484	3	649	5	394,21	16,43	8592667677296

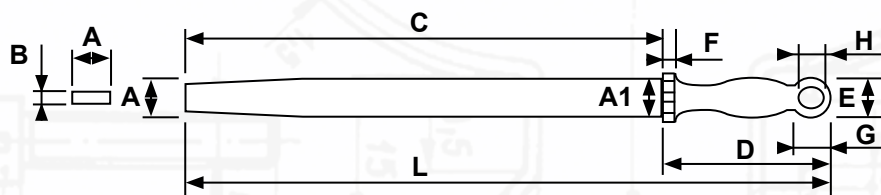

Pilník dílenský plochošpičatý PZA
Engineer's file flat PZA
Werkstattfeile flachspitz PZA

X Číslo seku
Cut number
Hiebnummer



kód/Code Bestellnummer	A (mm)	A1 (mm)	B (mm)	C (mm)	D (mm)	E (mm)	F (mm)	G (mm)	H (mm)	L (mm)	X	W (g)		DPC/RRP (Kč/czk)	DPC/RRP (EUR)	EAN13
4CZ-21127-1015	7,6	11,4	3	100	80	22	8	18	13x11	100	1	45	5	104,13	4,34	8592667751323
4CZ-21127-1025	7,6	11,4	3	100	80	22	8	18	13x11	100	2	45	5	109,09	4,55	8592667751316
4CZ-21127-1035	7,6	11,4	3	100	80	22	8	18	13x11	100	3	45	5	114,05	4,75	8592667751309
4CZ-21127-1515	10,3	15,2	4	150	110	30	8	28	18x14	150	1	120	5	134,71	5,61	8592667751293
4CZ-21127-1525	10,3	15,2	4	150	110	30	8	28	18x14	150	2	110	5	140,50	5,85	8592667751286
4CZ-21127-1535	10,3	15,2	4	150	110	30	8	28	18x14	150	3	115	5	148,76	6,20	8592667751279
4CZ-21127-2015	14,2	20,0	5	200	110	30	8	28	18x14	200	1	196	5	202,48	8,44	8592667751262
4CZ-21127-2025	14,2	20,0	5	200	110	30	8	28	18x14	200	2	200	5	213,22	8,88	8592667200340
4CZ-21127-2035	14,2	20,0	5	200	110	30	8	28	18x14	200	3	200	5	225,62	9,40	8592667751255
4CZ-21127-2515	17,8	24,8	6	250	110	30	8	28	18x14	250	1	339	5	241,32	10,06	8592667751248
4CZ-21127-2525	17,8	24,8	6	250	110	30	8	28	18x14	250	2	345	5	253,72	10,57	8592667751231
4CZ-21127-2535	17,8	24,8	6	250	110	30	8	28	18x14	250	3	342	5	269,42	11,23	8592667751224
4CZ-21127-3015	20,4	29,6	6,3	300	134	38	14	30	20x16	300	1	502	5	268,60	11,19	8592667751088
4CZ-21127-3025	20,4	29,6	6,3	300	134	38	14	30	20x16	300	2	495	5	282,64	11,78	8592667200357
4CZ-21127-3035	20,4	29,6	6,3	300	134	38	14	30	20x16	300	3	490	5	301,65	12,57	8592667751217

i Pilníky jsou dodávány se závěsným držákem. The files are supplied with a hanger. Die Feile werden mit einem Hängehalter geliefert.



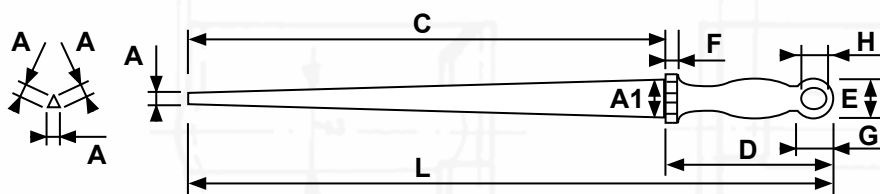

Pilník tříhranný - tvar PZT
File three-square - shape PZT
Feile dreikant - Form PZT

X Číslo seku
Cut number
Hiebnummer



kód/Code Bestellnummer	A (mm)	A1 (mm)	C (mm)	D (mm)	E (mm)	F (mm)	G (mm)	H (mm)	L (mm)	X	W (g)	DPC/RRP (Kč/czsk)	DPC/RRP (EUR)	EAN13	
4CZ-21150-1015	6	8	100	80	22	8	18	13x11	182	1	49	5	89,26	3,72	8592667677302
4CZ-21150-1025	6	8	100	80	22	8	18	13x11	182	2	49	5	95,04	3,96	8592667677319
4CZ-21150-1035	6	8	100	80	22	8	18	13x11	182	3	49	5	104,13	4,34	8592667677326
4CZ-21150-1515	7	10	150	80	22	8	18	13x11	230	1	119	5	118,18	4,92	8592667677333
4CZ-21150-1525	7	10	150	80	22	8	18	13x11	230	2	115	5	125,62	5,23	8592667161689
4CZ-21150-1535	7	10	150	80	22	8	18	13x11	230	3	118	5	139,67	5,82	8592667677340
4CZ-21150-2015	9	12	200	110	30	8	28	18x14	310	1	209	5	146,28	6,10	8592667677357
4CZ-21150-2025	9	12	200	110	30	8	28	18x14	310	2	214	5	153,72	6,40	8592667161696
4CZ-21150-2035	9	12	200	110	30	8	28	18x14	310	3	202	5	165,29	6,89	8592667677364
4CZ-21150-2515	12	17,5	250	110	30	8	28	18x14	360	1	338	5	213,22	8,88	8592667677371
4CZ-21150-2525	12	17,5	250	110	30	8	28	18x14	360	2	338	5	220,66	9,19	8592667161702
4CZ-21150-2535	12	17,5	250	110	30	8	28	18x14	360	3	363	5	239,67	9,99	8592667677388
4CZ-21150-3015	14	20	300	110	30	8	28	18x14	410	1	513	5	288,43	12,02	8592667677395
4CZ-21150-3025	14	20	300	110	30	8	28	18x14	410	2	517	5	299,17	12,47	8592667161719
4CZ-21150-3035	14	20	300	110	30	8	28	18x14	410	3	514	5	318,18	13,26	8592667677401

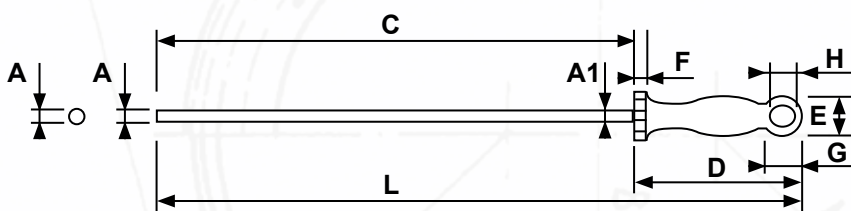

Pilník kruhový - tvar PZK
File round - shape PZK
Feile rund - Form PZK

X Číslo seku
Cut number
Hiebnummer



kód/Code Bestellnummer	A (mm)	A1 (mm)	C (mm)	D (mm)	E (mm)	F (mm)	G (mm)	H (mm)	L (mm)	X	W (g)	DPC/RRP (Kč/czsk)	DPC/RRP (EUR)	EAN13	
4CZ-21160-1015	3	4	100	80	22	8	18	13x11	178	1	33	5	70,25	2,93	8592667677449
4CZ-21160-1025	3	4	100	80	22	8	18	13x11	178	2	33	5	78,51	3,27	8592667677456
4CZ-21160-1035	3	4	100	80	22	8	18	13x11	178	3	33	5	85,12	3,55	8592667677463
4CZ-21160-1515	4	6	150	80	22	8	18	13x11	230	1	75	5	101,65	4,24	8592667677470
4CZ-21160-1525	4	6	150	80	22	8	18	13x11	230	2	75	5	105,79	4,41	8592667161726
4CZ-21160-1535	4	6	150	80	22	8	18	13x11	230	3	75	5	113,22	4,72	8592667677487
4CZ-21160-2015	5	8	200	110	30	8	28	18x14	310	1	115	5	118,18	4,92	8592667677494
4CZ-21160-2025	5	8	200	110	30	8	28	18x14	310	2	115	5	127,27	5,30	8592667161733
4CZ-21160-2035	5	8	200	110	30	8	28	18x14	310	3	114	5	140,50	5,85	8592667677500
4CZ-21160-2515	7	10	250	110	30	8	28	18x14	360	1	206	5	175,21	7,30	8592667677517
4CZ-21160-2525	7	10	250	110	30	8	28	18x14	360	2	212	5	183,47	7,64	8592667161740
4CZ-21160-2535	7	10	250	110	30	8	28	18x14	360	3	205	5	194,21	8,09	8592667677524
4CZ-21160-3015	9	12	300	110	30	8	28	18x14	410	1	305	5	213,22	8,88	8592667677531
4CZ-21160-3025	9	12	300	110	30	8	28	18x14	410	2	319	5	220,66	9,19	8592667161757
4CZ-21160-3035	9	12	300	110	30	8	28	18x14	410	3	314	5	235,54	9,81	8592667677548
4CZ-21160-3515	11,5	15	350	134	38	14	30	20x16	485	1	545	5	292,56	12,19	8592667677555
4CZ-21160-3525	11,5	15	350	134	38	14	30	20x16	485	2	572	5	309,92	12,91	8592667677562
4CZ-21160-3535	11,5	15	350	134	38	14	30	20x16	485	3	540	5	326,45	13,60	8592667677579

i Pilníky jsou dodávány se závěsným držákem. The files are supplied with a hanger. Die Feile werden mit einem Hängehalter geliefert.

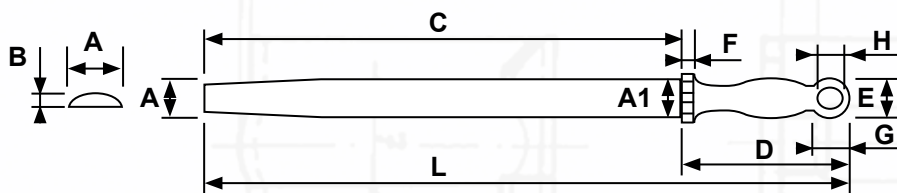

Pilník úsečový - tvar PZP
File halfround - shape PZP
Feile halbrund - Form PZP

X Číslo seku
Cut number
Hiebnummer



kód/Code Bestellnummer	A (mm)	A1 (mm)	B (mm)	C (mm)	D (mm)	E (mm)	F (mm)	G (mm)	H (mm)	L (mm)	X	W (g)	DPC/RRP (Kč/czk)	DPC/RRP (EUR)	EAN13	
4CZ-21163-1015	9,5	12	3,7	100	80	22	8	18	13x11	182	1	49	5	101,65	4,24	85926677586
4CZ-21163-1025	9,5	12	3,7	100	80	22	8	18	13x11	182	2	48	5	106,61	4,44	85926677593
4CZ-21163-1035	9,5	12	3,7	100	80	22	8	18	13x11	182	3	50	5	114,05	4,75	859266777609
4CZ-21163-1515	12	16	5	150	80	22	8	18	13x11	230	1	110	5	136,36	5,68	8592667677616
4CZ-21163-1525	12	16	5	150	80	22	8	18	13x11	230	2	108	5	145,45	6,06	8592667161764
4CZ-21163-1535	12	16	5	150	80	22	8	18	13x11	230	3	110	5	155,37	6,47	8592667677623
4CZ-21163-2015	15	20	6	200	110	30	8	28	18x14	310	1	165	5	175,21	7,30	8592667677630
4CZ-21163-2025	15	20	6	200	110	30	8	28	18x14	310	2	167	5	182,64	7,61	8592667161771
4CZ-21163-2035	15	20	6	200	110	30	8	28	18x14	310	3	174	5	195,04	8,13	8592667677647
4CZ-21163-2515	19	25	6	250	110	30	8	28	18x14	360	1	309	5	250,41	10,43	8592667677654
4CZ-21163-2525	19	25	6	250	110	30	8	28	18x14	360	2	293	5	260,33	10,85	8592667161788
4CZ-21163-2535	19	25	6	250	110	30	8	28	18x14	360	3	282	5	269,42	11,23	8592667677661
4CZ-21163-3015	23	28	6	300	110	30	8	28	18x14	410	1	470	5	311,57	12,98	8592667677678
4CZ-21163-3025	23	28	6	300	110	30	8	28	18x14	410	2	484	5	326,45	13,60	8592667161795
4CZ-21163-3035	23	28	6	300	110	30	8	28	18x14	410	3	464	5	353,72	14,74	8592667677685
4CZ-21163-3515	25	32	6	350	134	38	14	30	20x16	484	1	712	5	367,77	15,32	8592667677692
4CZ-21163-3525	25	32	6	350	134	38	14	30	20x16	484	2	729	5	386,78	16,12	8592667161801
4CZ-21163-3535	25	32	6	350	134	38	14	30	20x16	484	3	718	5	411,57	17,15	8592667677708

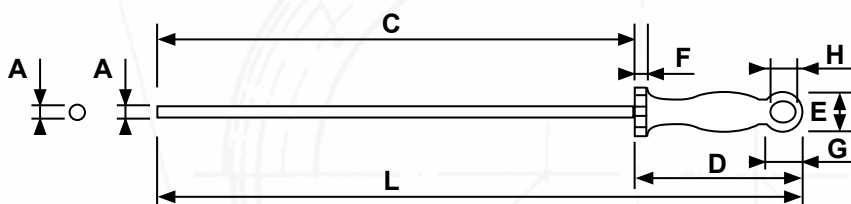

Pilník na řetězy motorových pil PIM
Chain saw file PIM
Sägekettenfeile 5,5 PIM

X Číslo seku
Cut number
Hiebnummer



kód/Code Bestellnummer	A (mm)	C (mm)	D (mm)	E (mm)	F (mm)	G (mm)	H (mm)	L (mm)	X	W (g)	DPC/RRP (Kč/czk)	DPC/RRP (EUR)	EAN13	
4CZ-21220-3235	3,2	200	80	22	8	18	13x11	280	3	34	5	57,85	2,41	8592667170667
4CZ-21220-3535	3,5	200	80	22	8	18	13x11	280	3	35	5	61,16	2,55	8592667170674
4CZ-21220-0435	4	200	80	22	8	18	13x11	280	3	41	5	61,16	2,55	8592667170650
4CZ-21220-4535	4,5	200	80	22	8	18	13x11	280	3	40	5	61,16	2,55	8592667170681
4CZ-21220-4835	4,8	200	80	22	8	18	13x11	280	3	50	5	61,16	2,55	8592667170698
4CZ-21220-5235	5,2	200	80	22	8	18	13x11	280	3	52	5	61,16	2,55	8592667170704
4CZ-21220-5535	5,5	200	80	22	8	18	13x11	280	3	63	5	61,16	2,55	8592667170711

i Pilníky jsou dodávány se závěsným držákem. The files are supplied with a hanger. Die Feile werden mit einem Hängehalter geliefert.

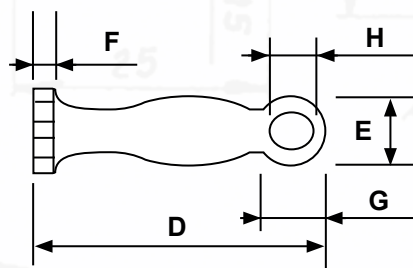

Plastové držadlo
Plastic handle
Kunststoffgriff

kód/Code Bestellnummer	D (mm)	E (mm)	F (mm)	G (mm)	H (mm)	W (g)	DPC/RRP (Kč/czk)	DPC/RRP (EUR)	EAN13	
4CZ-42656-2824	80	22	8	18	13x11	14	1	37,27	1,55	8592667181014
4CZ-42656-2826	110	30	8	28	18x14	39	1	59,50	2,48	8592667181021
4CZ-42656-2828	134	38	14	30	20x16	62	1	97,52	4,06	8592667181038



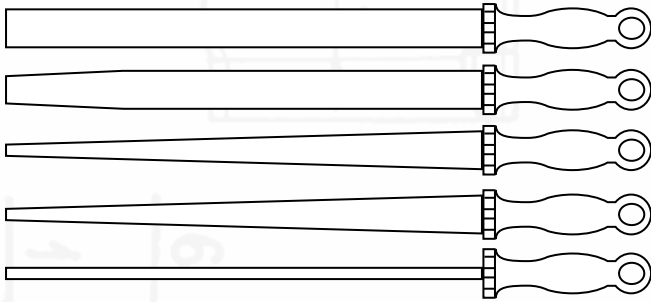

Sada pilníků dílenských pětídílná
Set of engineer's files - 5 pcs
Werkstattfeile-Satz 5-teilig

X Číslo seku
Cut number
Hiebnummer

kód/Code Bestellnummer	obsah / content / Inhalt	L	X	W (g)		DPC/RRP (Kč/czK)	DPC/RRP (EUR)	EAN13
4CZ-21192-1515	plochý + úsečový + tříhranný + čtyřhranný + kruhový flat + halfround + threesquare + square + round flach + halbrund + dreikant + quadratisch + rund	150	1	510	1	598,35	24,93	8592667191624
4CZ-21192-1525		150	2	520	1	593,39	24,72	8592667733503
4CZ-21192-1535		150	3	520	1	694,21	28,93	8592667191631
4CZ-21192-2015		200	1	790	1	734,71	30,61	8592667191648
4CZ-21192-2025		200	2	820	1	762,81	31,78	8592667165212
4CZ-21192-2035		200	3	830	1	852,89	35,54	8592667191655
4CZ-21192-2515		250	1	1460	1	1050,41	43,77	8592667191662
4CZ-21192-2525		250	2	1460	1	1095,87	45,66	8592667734487
4CZ-21192-2535		250	3	1480	1	1165,29	48,55	8592667191679

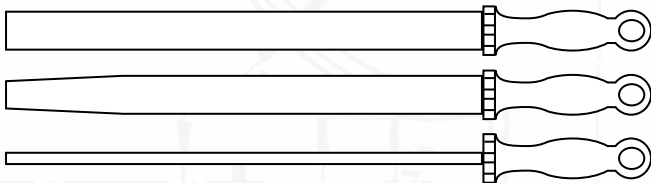

Sada pilníků dílenských třídílná
Set of engineer's files - 3 pcs
Werkstattfeile-Satz 3-teilig

X Číslo seku
Cut number
Hiebnummer

kód/Code Bestellnummer	obsah / content / Inhalt	L	X	W (g)		DPC/RRP (Kč/czK)	DPC/RRP (EUR)	EAN13
4CZ-21193-1515	plochý + úsečový + kruhový flat + halfround + round flach + halbrund + rund	150	1	315	1	363,64	15,15	8592667191688
4CZ-21193-1525		150	2	320	1	374,38	15,60	8592667733510
4CZ-21193-1535		150	3	305	1	411,57	17,15	8592667191693
4CZ-21193-2015		200	1	480	1	443,80	18,49	8592667191709
4CZ-21193-2025		200	2	470	1	459,50	19,15	8592667733497
4CZ-21193-2035		200	3	490	1	513,22	21,38	8592667191716
4CZ-21193-2515		250	1	870	1	638,02	26,58	8592667191730
4CZ-21193-2525		250	2	870	1	611,57	25,48	8592667733633
4CZ-21193-2535		250	3	880	1	696,69	29,03	8592667191723



Kód / Code / Bestellnummer

4CZ-221

Industry
line

**DIN
7263**

**HRC
53**



POUŽITÍ

Rašple s dřevěnou rukojetí, strojně sekané. Pro běžnou práci se dřevem, překližkami, obkladovými deskami, plasty a jinými měkkými materiály. Ergonomická rukojeť z kvalitního dřeva pro pohodlný úchop. Otvor v rukojeti umožňuje zavěšení. Rašplové zuby na činných plochách jsou umístěny střídavě, aby umožnily rovnoměrné obrábění materiálu. Čepel je vyrobená z nástrojové, tepelně zpracované oceli na tvrdost 53 HRC (normou požadovaná tvrdost je 48-50 HRC).



USABILITY

Rasps with wooden handle, machine cut. For general work with wood, plywood, paneling, plastics and other soft materials. Ergonomic handle made of quality wood for a comfortable grip. A hole in the handle allows hanging. The rasp teeth on the active areas are positioned alternately to enable uniform machining of the material. The blades are made of tool steel, heat-treated to a hardness of 53 HRC (the standard hardness is 48-50 HRC).



VERWENDUNG

Raspel mit Holzgriff, mit Maschinenhieb. Für allgemeine Arbeiten mit Holz, Sperrholz, Paneelen, Kunststoffen und anderen weichen Materialien. Ergonomischer Griff aus hochwertigem Holz für angenehmen Griff. Ein Loch im Griff ermöglicht das Aufhängen. Die Raspelzähne auf den Wirkflächen sind wechselseitig angeordnet, um eine gleichmäßige Bearbeitung des Materials zu ermöglichen. Die Klingen sind aus Werkzeugstahl, wärmebehandelt auf eine Härte von 53 HRC (die von der Norm geforderte Härte beträgt 48-50 HRC).

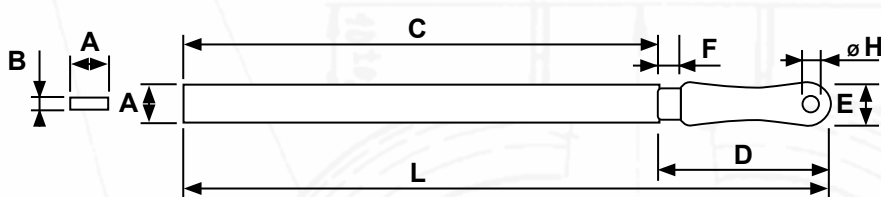

Rašple plochá strojní sek PRO
Hand rasp machine cut PRO
Flachraspel Maschinenhieb PRO

X Číslo seku
Cut number
Hiebnummer



kód/Code Bestellnummer	A (mm)	B (mm)	C (mm)	D (mm)	E (mm)	F (mm)	Ø H (mm)	L (mm)	X	W (g)	DPC/RRP (Kč/czk)	DPC/RRP (EUR)	EAN13	
4CZ-22174-1525	15,3	5	150	110	27	12	6	265	2	106	5	201,65	8,40	8592667170728
4CZ-22174-2025	20	6	200	110	27	12	6	320	2	189	5	244,63	10,19	8592667170735
4CZ-22174-2525	25,2	7,8	250	130	31	18	8	390	2	349	5	318,18	13,26	8592667170742
4CZ-22174-3025	30	8	300	130	31	18	8	445	2	498	5	341,32	14,22	8592667170759

Plochy s rašplovým sekem, jedna hrana s jednoduchým sekem.
Areas with a rasp cut, one edge with a simple cut.
Flächen mit Raspelhieb, eine Kante mit einfachem Hieb.

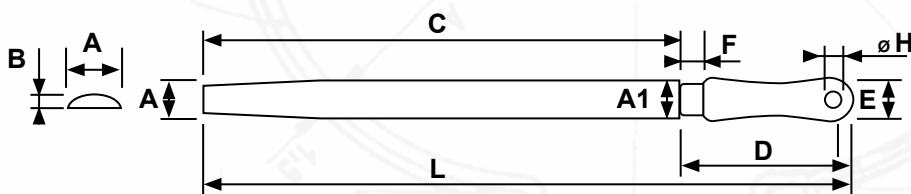

Rašple úsečová strojní sek PRP
Halfround rasp machine cut PRP
Halbrundraspel Maschinenhieb PRP

X Číslo seku
Cut number
Hiebnummer



kód/Code Bestellnummer	A (mm)	A1 (mm)	B (mm)	C (mm)	D (mm)	E (mm)	F (mm)	Ø H (mm)	L (mm)	X	W (g)	DPC/RRP (Kč/czk)	DPC/RRP (EUR)	EAN13	
4CZ-22175-1525	4	16	6	150	110	27	12	6	265	2	102	5	260,33	10,85	8592667170766
4CZ-22175-2025	17,5	20,5	7,8	200	110	27	12	6	320	2	173	5	318,18	13,26	8592667170773
4CZ-22175-2525	21,5	25	9	250	130	31	18	8	390	2	316	5	399,17	16,63	8592667170780
4CZ-22175-3025	24	30	10	300	130	31	18	8	445	2	487	5	472,73	19,70	8592667170797

Plochy s rašplovým sekem, hrany s jednoduchým sekem.
Areas with a rasp cut, edges with a simple cut.
Flächen mit Raspelhieb, Kanten mit einfachem Hieb.



i Rašple jsou dodávány se závěsným držákem.
The rasps are supplied with a hanger.
Die Raspel werden mit einem Hängehalter geliefert.

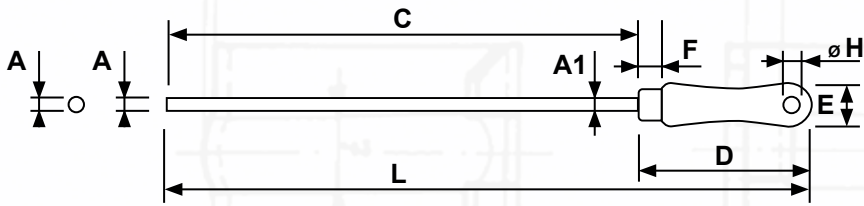

Rašple kruhová strojní sek 6 PRK
Round rasp machine cut 6 PRK
Rundraspel Maschinenhieb 6 PRK

X Číslo seku
Cut number
Hiebnummer

kód/Code Bestellnummer	A (mm)	A1 (mm)	C (mm)	D (mm)	E (mm)	F (mm)	Ø H (mm)	L (mm)	X	W (g)		DPC/RRP (Kč/czk)	DPC/RRP (EUR)	EAN13
4CZ-22177-1525	5,5	6,2	150	100	27	12	6	265	2	71	5	155,37	6,47	8592667170803
4CZ-22177-2025	7	8	200	100	27	12	6	320	2	111	5	195,04	8,13	8592667170810
4CZ-22177-2525	8,5	10,5	250	130	31	18	8	390	2	199	5	262,81	10,95	8592667170827
4CZ-22177-3025	8,5	12,5	300	130	31	18	8	335	2	303	5	323,14	13,46	8592667170834

Plocha s rašplovým sekem.
Area with a rasp cut.
Fläche mit Raspelhieb.

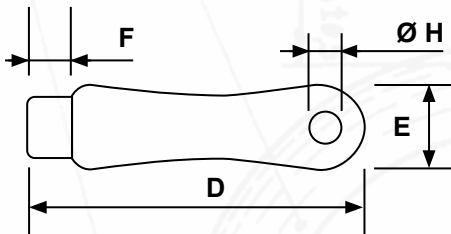

Násada na pilník a rašple dřevěná
File and rasp handle wooden
Feilen- und Raspelgriff aus Holz

kód/Code Bestellnummer	D (mm)	E (mm)	F (mm)	Ø H (mm)	W (g)		DPC/RRP (Kč/czk)	DPC/RRP (EUR)	EAN13
4CZ-43656-0110	110	27	12	6	35	1	123,14	5,13	8592667755772
4CZ-43656-0130	130	31	18	8	60	1	139,67	5,82	8592667180574

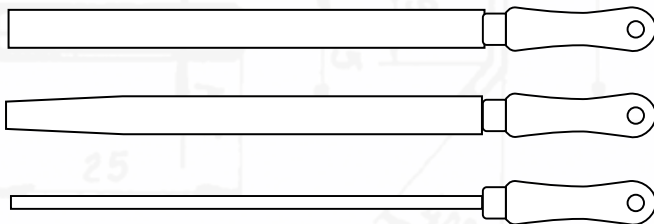

Sada rašplí strojní sek třídičná
Set of rasps machine cut - 3 pcs
Raspelsatz Maschinenhieb 3-teilig

X Číslo seku
Cut number
Hiebnummer

kód/Code Bestellnummer	A	L (mm)	X	W (g)		DPC/RRP (Kč/czk)	DPC/RRP (EUR)	EAN13
4CZ-22193-1525	plochá + úsečová + kruhová	150	2	338	1	600,00	25,00	8592667733480
4CZ-22193-2025	flat + halfround + round	200	2	536	1	696,69	29,03	8592667733619
4CZ-22193-2525	flach + halbrund + rund	250	2	950	1	877,69	36,57	8592667733626





Kód / Code / Bestellnummer

4CZ-SM

Industry
line

ABS



POUŽITÍ



USABILITY



VERWENDUNG

Svinovací metr 4Czech v provedení s příjemným pogumovaným protiskluzovým povrchem je opatřen dvěma brzdami pro snadnější ovládání. Nylonový pásek s metrickými rozměry je oboustranný a zakončen gumovým hákem pro snadnější uchytení metru na oblých předmětech a zároveň magnetickou hlavou pro upnutí ke kovovým materiálům.

Tape measure 4Czech with pleasant rubberized antislip surface is supplied with two brakes for easier control. The nylon tape with metric sizes is two-side and finished with a rubber hook for easier attachment of the tape on arc surfaces together with magnetic head for fastening to metal materials.

4Czech Taschenrollbandmaß ausgeführt mit anti-rutsche Oberfläche ist mit zwei Bremsen ausgerüstet für einfachere Bedienung. Der Nylon-Band ist doppelseitig und beendet mit Gummihacken mit einem Magnet für einfachere aufhängung auf alle Materialien.

kód/Code Bestellnummer	délka/length (m)	šířka/width (mm)	odchylka/error (mm)	W (g)	6	DPC/RRP (Kč/czk)	DPC/RRP (EUR)	EAN13
4CZ-SM-0316	3,00	16,0	0,9	104	6	233,06	9,71	8592667039025
4CZ-SM-0519	5,00	19,0	1,3	214	6	295,04	12,29	8592667039032
4CZ-SM-0825	8,00	25,0	1,9	400	6	352,89	14,70	8592667039049
4CZ-SM-1025	10,00	25,0	2,3	420	6	362,81	15,12	8592667039056

Protiskluzový klip, aktivní brzdny systém Antislip clip, active braking system Antirutschclip, Aktives Bremssystem



Metr je
- oboustranný
- s magnetickou hlavou
- s nylonovým povrchem

Gumový hák
Výkonný hák umožňuje se pevně přichytit na jakýkoliv materiál a tvar předmětu.

Protiskluzový klip
ABS materiál s doplňkovým stříbrným klipem uvnitř hlavního klipu působí protiskluzově a prodlužuje životnost výrobku.

ABS hák
Automaticky brzdicí mechanismus jednoduše vytáhne pásku a automaticky ji zamkne na požadovaném místě.

Aktivní brzdící systém
Jednoduše vyjždějí pásku a automaticky zamykání v místě vestavěného gumového nárazníku chrání od poničení pásky.

The tape is
- two-side
- with magnetic head
- with nylon surface

The rubber hook
efficient hook enables to firmly attach to any material and form of objects.

Anti-slip clip
ABS material with accessory silver clip inside main clip works in anti-slip way and prolongs lifetime of the product.

ABS hook
Automatically braking mechanism easily pulls out the tape and automatically locks it on the required place.

Active braking system
The tape easily pulls out and automatically locks in the place of the inbuilt rubber bumper in order to protect it from damaging the tape.

Das Messband ist
- doppelseitig
- mit magnetischen Kopf
- Nylonoberfläche

Gummihacken
Der Hacken ermöglicht richtige Befestigung auf alle Arten von Materialien und Oberflächen.

Antirutschclip
ABS Material mit Zusatz Silberclip im Hauptclip verursacht Verlängerung der Lebensdauer des Messbandes.

ABS Hacken
Automatische Bremsmechanismus zieht das Band und Sperrt sie automatisch auf der gewünschte Stelle.

Aktivier Bremssystem
Der Band kommt einfach raus und automatische Sperre im Gummipuffer schützt Ihn gegen Beschädigung.

Samosblížující se hák zajišťuje přesnost pro vnitřní a vnější měření.

Self-aligning hook ensures accuracy for internal and external measurements.

Der Selbstnäherne Hacken sichert Genauigkeit für innen und außen Abmessung.

NULL
ZERO
NULL

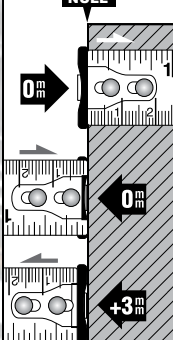

**POZOR
DANGER
ACHTUNG**

Při magnetickém vnějším měření přidejte 3mm k celkovému výsledku měření.

When taking magnetic external measurements, add 3 mm.

Beim Außenabmessen rechnen Sie zusätzlich 3 mm zur Gesamtlänge.

Metry 4Czech jsou velmi přesné, plně odpovídající evropské třídě přesnosti II., při délce 3,0 m je maximální povolená odchylka menší než milimetr. 4Czech measuring tapes are very accurate, fully corresponding to the European accuracy class II. The maximum allowed measurement error is smaller than one millimetre on the tape with length of 3,0 m. Die 4 Czech Messbänder sind sehr genau, und Entsprechen der Europäischer Genauigkeit-sklaße II., in der Länge von 3,0 m ist die maximale Abweichung weniger als 1 mm.

Na klip pásky je použitý stejný materiál jako na obalu metru pro poutavý a příjemnější dotek.

The tape clip is made from the same material as the tape coat for attractive and more comfortable touch.

Der Bandclip besteht aus dem gleichen Material wie Kern des Messbandes für die angenehme Berührung.

Ergonomický vzhled 30° zkosení a tři čočkovitých úchyty na spodní straně obalu perfektně sedí v ruce.

Dvojitý zamykací systém. Tlačítko na zastavení dovolí pásku se zastavit v jakékoliv pozici.

Gumový ovládací hák. Výkonný hák umožňuje se přichytit na jakýkoliv materiál a tvar.

Ergonomical design: 30° bevel and 3 fillisters design at the bottom of the case fits your hand perfectly

Double locking system: Pause button allows blade to be stopped in any position.

Rubber grip hook: powerful hook allows grip on any materials and shapes

Ergonomischer Aussehen 30° Gehung und drei Linsengriffe auf der Rückseite passen perfekt in die Hand.

Doppelsperrsystem - Der Bremsknopf ermöglicht das Band in jeder Position zu Stoppen.

Gummibedienungshacken - Der Hacken ermöglicht richtige Befestigung auf alle Arten von Materialien und Oberflächen.



Metr je opatřen poutkem a klipem na snadné zavěšení. The tape is supplied with a hanger and a clip for easy hanging. Das Messband ist mit eine Öse und einem Klip ausgestattet für einfache Aufhängung.

POZOR / DANGER / ACHTUNG

- Nedovolte pásku metru přijít do kontaktu s jakýmkoliv rozpouštědlem.
- Okraj pásky je ostrý, když pásku zatahujete, držte své prsty v bezpečné vzdálenosti.
- Páska je elektricky vodivá. Nepoužívejte ji v blízkosti elektriny.
- Lehkou silou odemknete tlačítko, abyste zabránili zatažení pásky v plné rychlosti.

- Don't allow the tape to be in contact with any solvent.
- The tape edge is sharp when hiding the tape, keep your fingers in safe distance.
- The tape is electrically conductive. Don't use it near electricity.
- Unlock the button with light strength to prevent the full time speed hiding of the tape.

- Erlauben Sie nicht dass der Band in dem Kontakt mit einem Lösungsmittel kommt.
- Rand des Bandes ist scharf, halten Sie Ihre Finger im Abstand bei der Manipulation.
- Der Band besteht aus einem Leiterwerkstoffmaterial. Benutzen Sie ihn nicht in der Nähe von elektrischen Geräten.
- Den Knopf sperren Sie mit sanften Druck ab um vermeiden dass der Band sich mit voller Geschwindigkeit hineinzieht.



Kód / Code / Bestellnummer

4CZ-VZS

Standard
line

ISO
9001



POUŽITÍ

Vytahováč šroubů je několikabřitý nástroj, jehož mírně kuželovitá funkční část se při použití nasadí do předem vyvrtaného otvoru vhodné velikosti v zalomené části šroubu a pozvolným otáčením tohoto nástroje se dosáhne uvolnění šroubu. Určeno pro všechny druhy elektrických nebo akumulátorových vrtáček a šroubováků.



USABILITY

A screw extractor is a tool consisting of several cutting edges whose slightly taper functional part is fixed into a pre-drilled hole of appropriate size in the screw's broken part. The screw is released by slow rotation of this tool. Used for all kinds of electric and accumulator drills and screwdrivers.



VERWENDUNG

Schraubenausdreher ist ein Multischneider Werkzeug, dessen Konische Kopf man direkt auf die Abgebrochene Schraube einsetzt und durch die allmähliche Drehung wird die Schraube locker. Geeignet für alle arten von elektrischen oder Akku Bohrmaschinen und Schraubenziehern.

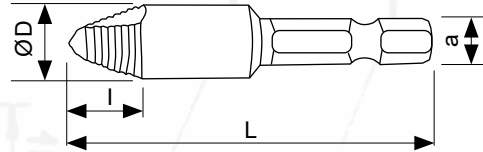

Vytahováč zalomených šroubů s vrtákem HSS
Screw extractor with drill HSS
Schraubenausdreher HSS

kód/Code Bestellnummer	číslo number	L (mm)	l (mm)	D (mm)	a (mm)	W (g)		DPC/RRP (Kč/czk)	DPC/RRP (EUR)	EAN13
4CZ-VZS-00	0	54	6,5	6	6,4	13	1	53,72	2,24	8592667431140
4CZ-VZS-01	1	54	6,5	7	6,4	14	1	53,72	2,24	8592667431157
4CZ-VZS-02	2	54	12	10	6,4	20	1	67,77	2,82	8592667431164
4CZ-VZS-03	3	54	10,5	11	6,4	23	1	76,86	3,20	8592667431171
4CZ-VZS-04	4	54	10,5	11,8	6,4	27	1	84,30	3,51	8592667431188

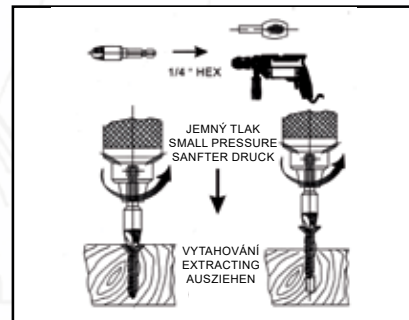

Číslo No. Number	Odstraňuje tyto typy šroubů Removes these types of screws Entfernt diese Schraubentypen	Otáčky vytahovače Extractor's revolutions Schraube- ausdreher Drehzahl
0.		150 ~ 250 ot./min-1 Používejte nízké otáčky Use low revolutions Niedrige Drehzahl nutzen
1.		
2.		
3.		
4.		

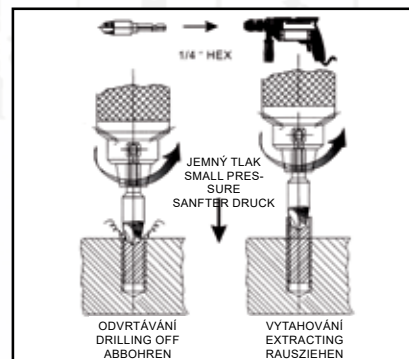

Číslo No. Number	Průměr vytáhaného šroubu Diameter of extracted screw Schraubendurchmesser	Otáčky vytahovače Extractor's revolutions Schraube- ausdreher Drehzahl
0.	1/4" - 6mm	700 ~ 800 ot. min-1
1.	5/16" - 8mm	600 ~ 700 ot. min-1
2.	3/8" - 10mm	500 ~ 600 ot. min-1
3.	1/2" - 12mm	400 ~ 500 ot. min-1
4.	9/16" - 14mm	300 ~ 400 ot. min-1



- ideální pro rychlé a jednoduché vytažení stržených, zničených nebo protočených šroubů
- vhodné pro všechny druhy elektrických vrtáček, nebo bateriových vrtáček
- vytahuje křížové, hvězdičkové, imbusové šrouby a jiné typy šroubů
- doplněno o tvrdou plastovou krabičku pro skladování

Bezpečnostní poučení

- vždy používat ochranné brýle
- poříčené šrouby nebo bity se mohou roztržít
- před dotekem hollýma rukama nechat vychladnout
- držet ruce a jiné části těla mimo dráhu pohybu rotujících bitů
- dodržte všechny bezpečnostní instrukce poskytované výrobcem elektrického nástroje

- ideal for fast and easy extracting of stripped, damaged or spinning screws
- suitable for all kinds of electric drills or battery-operated drills
- extracts Phillips, Torx, socket head and other screws
- supplied with hard plastic box for storage

Safety information

- always use protective glasses
- damaged screws or bits can shatter
- let the screw get cold before touch with your hands
- keep your hands and other parts of body out of the rotating bits way
- follow all safety instructions provided by a supplier of the electric tool

Sada vytahováčů poškozených šroubů HSS 5-dílná 6.0,1,2,3,4
5pcs set of damaged screws extractors HSS No.0,1,2,3,4
5-fache Schraubenausdreher Satz HSS Nummer 0,1,2,3,4

kód/Code Bestellnummer	W (g)		DPC/RRP (Kč/czk)	DPC/RRP (EUR)	EAN13
4CZ-VZS-SET	148	1	406,61	16,94	8592667034006

obsah / content / Inhalt	Číslo / Number / Nummer
Vytahováč zalomených šroubů s vrtákem HSS Screw extractor with drill HSS / Schraubenausdreher HSS	0; 1; 2; 3; 4

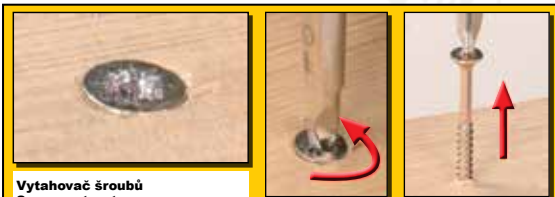

Vytahováč šroubů
Screw extractor
Schraubenausdreher

Průměr vytahováče šroubů
Diameter of screw extractor
Schraubenausdreherdurchmesser



číslo / no. 0.	číslo / no. 1.	číslo / no. 2.	číslo / no. 3.	číslo / no. 4.
< Ø 6mm	+/- Ø 6mm	+/- Ø 10mm	+/- Ø 12mm	+/- Ø 14mm

- Ideal für schnelle und einfache Aufziehen von Kaputen, abgebrochenen oder durchgetreten Schrauben
- Geeignet für alle arten von elektrischen oder Akku Bohrmaschinen und Schraubenziehern
- Entlässt Kreuz, Stern und Inbusschrauben und weitere Typen
- Inklusive Plastikbox für die Lagerung

Sicherheitshinweise

- benutzen Sie Schutzbrille bei der Arbeit
- beschädigte Schrauben können sich zerschmettern
- vor Berührung Abkühlen lassen
- halten Sie Hände und andere Körperteile außerhalb rotierender Biten
- halten Sie alle Sicherheitsinstruktionen Herstellers ein

Poznámka:

Pokud vytahuje těžko odstranitelné šrouby, může být nutné vynaložit více síly nebo umístit pozici vytahováče do malého úhlu 5-10° k šroubu.

Note:

If we extract hardly removable screws, it is necessary to put more strength or place the extractor's position to the small angle of 5-10 degrees toward the screw.

Bemerkung:

Beim Komplizierten Beschädigungen ist es notwendig mehr Kraft aufwenden oder den Schraubenausdreher im Winkel von 5-10° positionieren.

Patent č.200720107489.8

POZOR





Kód / Code / Bestellnummer

4CZ-TM

Industry
line

CrV



POUŽITÍ

Mechanický trháč matic pro trhání neuvolnitelných nebo přetočených matic (do třídy jakosti 6) bez poškození dřívků šroubů. Snadné vytvoření sekáče (s kaleným břitem), bez uvíznutí. Vyrobeno z jakostní Chrom-Vanadiové oceli.



USABILITY

Mechanical nut splitter from splitting seized or overtightened nuts (up to strength class 6) without damaging the bolt thread. The splitter chisel (with hardened blade) slides easily, without sticking. Made of high quality chromium-vanadium steel.



VERWENDUNG

Mechanischer Mutternsprenger zum Zersprengen von festsitzenden oder überdrehten Muttern (bis Güteklasse 6) ohne Beschädigung der Schraubenbolzen. Leichtes Herausdrehen des Meißels (mit gehärteter Schneide), kein Hängenbleiben. Aus hochwertigem Chrom-Vanadium-Stahl gefertigt.

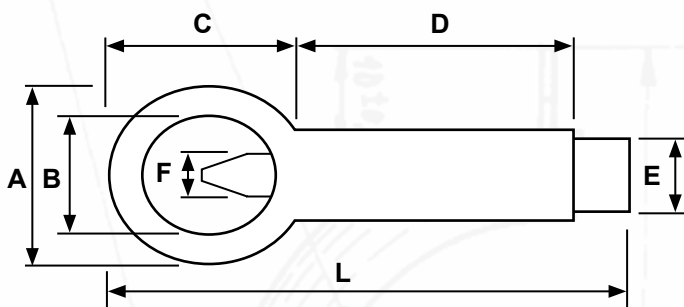

Trháč matic mechanický
Mechanical nut splitter
Mechanischer Mutternsprenger

kód/Code Bestellnummer	rozsah / range Breite (mm)	A (mm)	B (mm)	C (mm)	D (mm)	E (mm)	F (mm)	L (mm)	W (g)	 DPC/RRP (Kč/czk)	DPC/RRP (EUR)	EAN13	
4CZ-TM-M6-M10	1/2 - 5/8" M6 - M10	31	20	31	50	14	10	94	164	10	276,03	11,50	8592667146068
4CZ-TM-M10-M16	5/8 - 7/8" M10 - M16	45	30	45	65	19	14	123	411	10	338,84	14,12	8592667146051



Kód / Code / Bestellnummer

4CZ-H

Industry
line

ČSN
241323

ČSN
241320

DIN
6349



POUŽITÍ

Rychloupínací sklíčidlo je určeno pro rychlé ruční upnutí (dotažení) pracovního nástroje ke stroji. Je-li v celokovovém provedení, pak se vyznačuje menší házivostí a větší odolností proti opotřebení než sklíčidla v plastovém plášti. Ocelové čelisti mohou být na upínacích ploškách vybaveny tvrdokovovými destičkami, které zvyšují stisk sklíčidla a nepodléhají rychlému opotřebení.

Zubové sklíčidlo díky zubovému mechanismu pro dotažení čelistí nabízí větší upínací sílu než rychloupínací sklíčidlo. Sklíčidla s větším rozsahem mohou být vybavena pojistným zámek, který slouží jako jištění proti uvolnění nástroje během vrtání nebo šroubování. Vždy jsou celokovová a jsou určena pro ruční nebo stacionární vrtačky do mnoha průmyslových oborů.



USABILITY

Quick-clamping chucks are used for fast manual clamping (tightening) of a workpiece into a machine. If it is in all-metal execution, it has lower runout and greater wear-resistance than chucks in plastic coat. On steel jaws there can be carbide plates which increase chuck's press and the chucks are not worn out so fast.

Jaw chucks offer bigger clamping force than the quick-clamping chucks due to tooth mechanism for tightening jaws. Chucks with greater range can be equipped with safety lock which serves as a protection against tool's release during drilling or screwing. They are always all-metal and are used for manual or stationary drilling machines in many industrial areas.



VERWENDUNG

Das Schnellspannfutter ist für ein schnelles manuelles Einspannen (Nachziehen) des Werkzeugs in der Maschine vorgesehen. Bei Vollmetallausführung zeichnet es sich durch eine geringere Unwucht und höhere Verschleißfestigkeit als Spannfutter im Kunststoffmantel aus. Die Stahlbacken können auf den Spannflächen mit Hartmetallplättchen besetzt sein, welche den Druck des Spannfutters erhöhen und keinem schnellen Verschleiß unterliegen.

Ein Zahnkranz-Bohrfutter bietet dank dem Zahnmechanismus zum Festziehen der Backen eine höhere Spannkraft als ein Schnellspannfutter. Spannfutter mit größerer Spannweite können mit einem Sicherungsschloss ausgestattet werden, das als Sicherung gegen ein Lösen des Werkzeugs während des Bohrens oder Schraubens dient. Sie werden immer in Vollmetall ausgeführt und sind für Hand- oder Standbohrmaschinen in zahlreichen Industriebereichen vorgesehen.

U Upínací kužel/závit
clamping taper/thread
Spannkonus/Gewinde

H Házivost
Runout
Unrundheit

W Hmotnost
Weight
Gewicht

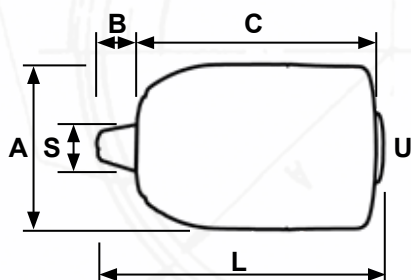

Skličidlo vrtačkové rychloupínací, plastové, se závitem
Drill chuck self-tightening, plastic, with thread
Bohrfutter mit Radialverriegelung Kunststoffausführung, mit Gewinde

kód/Code Bestellnummer	S (mm)	L (mm)	A (mm)	B (mm)	C (mm)	U	H (mm)	W (g)		DPC/RRP (Kč/czk)	DPC/RRP (EUR)	EAN13
4CZ-H10R-1/2	1-10	60,5	41,2	10	50,8	1/2" 20UNF	< 0,35	140	1	426,45	17,77	8592667124127
4CZ-H13R-1/2	1,5-13	72,8	43,2	10,8	62	1/2" 20UNF	< 0,35	250	1	617,36	25,72	8592667124219
4CZ-H13R-3/8	1,5-13	71,2	42,9	9,2	62	3/8" 24UNF	< 0,35	250	1	613,22	25,55	8592667124226

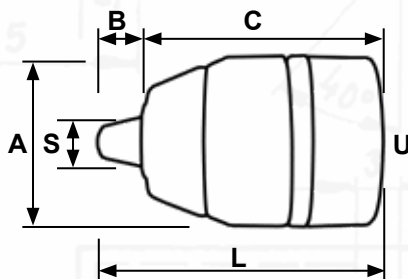

Skličidlo vrtačkové rychloupínací, kovové Lock HM, se závitem
Drill chuck self-tightening, metal Lock HM, with thread
Bohrfutter mit Radialverriegelung Metallausführung, mit Gewinde

kód/Code Bestellnummer	S (mm)	L (mm)	A (mm)	B (mm)	C (mm)	U	H (mm)	W (g)		DPC/RRP (Kč/czk)	DPC/RRP (EUR)	EAN13
4CZ-H10RK-1/2	0,8-10	63,1	41	8,5	54,6	1/2" 20UNF	< 0,35	200	1	411,57	17,15	8592667124134
4CZ-H10RK-3/8	0,8-10	64,1	41,4	9,5	54,6	3/8" 24UNF	< 0,35	200	1	523,97	21,83	8592667124141
4CZ-H13RK-1/2	1,5-13	71,8	42,7	12,2	59,6	1/2" 20UNF	< 0,35	250	1	904,13	37,67	8592667124233
4CZ-H13RK-3/8	1,5-13	67,1	42,7	7,5	59,6	3/8" 24UNF	< 0,35	250	1	897,52	37,40	8592667124240

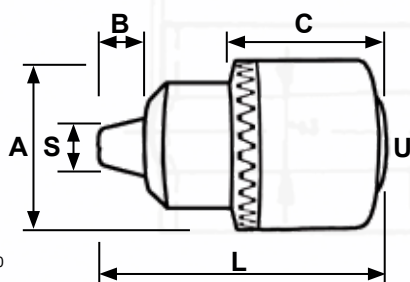

ČSN 241320

Skličidlo vrtačkové zubové s klíčkou, s kuželem/se závitem
Gear chuck with key, with taper/thread
Zahnkranz-Bohrfutter mit Schlüssel, mit Konus/gewinde

kód/Code Bestellnummer	S (mm)	L (mm)	A (mm)	B (mm)	C (mm)	U	H (mm)	W (g)		DPC/RRP (Kč/czk)	DPC/RRP (EUR)	EAN13
4CZ-H06K-3/8	0,6-6	49,2	29,9	9,4	26,6	3/8" 24UNF	< 0,35	100	1	320,66	13,36	8592667124028
4CZ-H06K-B10	0,6-6	49,7	30	9,6	25,2	B10	< 0,35	100	1	244,63	10,19	8592667124035
4CZ-H10K-1/2	1-10	59,7	33,4	10,1	31,9	1/2" 20UNF	< 0,35	150	1	258,68	10,78	8592667124080
4CZ-H10K-3/8	1-10	60,1	33,2	10,5	32	3/8" 24UNF	< 0,35	150	1	285,12	11,88	8592667124097
4CZ-H10K-B12	1-10	59,1	33,2	10,2	31,7	B12	< 0,35	610	1	305,79	12,74	8592667124103
4CZ-H10K-M14	1-10	60	33,2	11	32	M14	< 0,35	180	1	337,19	14,05	859266714342
4CZ-H13K-1/2	1,5-13	70,4	42,2	14	34,5	1/2" 20UNF	< 0,35	250	1	270,25	11,26	8592667124172
4CZ-H13K-3/8	1,5-13	69,3	42	12,8	36,7	3/8" 24UNF	< 0,35	280	1	300,83	12,53	8592667124189
4CZ-H13K-B12	1,5-13	70	42	12,5	36,2	B12	< 0,35	280	1	351,24	14,63	8592667124196
4CZ-H13K-B16	1,5-13	70	42	13	36,2	B16	< 0,35	270	1	342,98	14,29	8592667124202
4CZ-H16K-1/2	3-16	83,9	50,8	15,5	44,5	1/2" 20UNF	< 0,25	520	1	428,10	17,84	8592667124271
4CZ-H16K-5/8	3-16	83	50,5	15	44,5	5/8" 16UNF	< 0,25	500	1	527,27	21,97	8592667124288
4CZ-H16K-B16	3-16	80,4	50,9	12,4	44,4	B16	< 0,25	490	1	527,27	21,97	8592667124295
4CZ-H16K-B18	3-16	84,9	51	16,1	44,9	B18	< 0,25	490	1	527,27	21,97	8592667124301
4CZ-H20K-B22	5-20	105	65	21,2	56,2	B22	< 0,18	1134	1	825,62	34,40	8592667124349

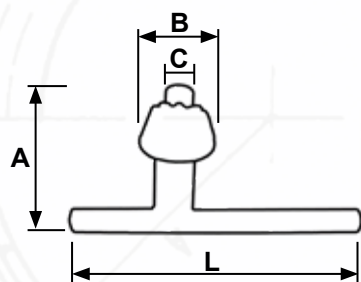

DIN 6349

Náhradní klíčka pro vrtačí skličidla s ozubením
Replacement key for gear rim chuck
Ersatz-Schlüssel für Zahnkranz-Bohrfutter

S - upínací rozměr skličidla
S - clamping dimension of the chuck
S - Spanmaß des Bohrfutters

kód/Code Bestellnummer	S (mm)	L (mm)	A (mm)	B (mm)	C (mm)	W (g)		DPC/RRP (Kč/czk)	DPC/RRP (EUR)	EAN13
4CZ-HKL10	6 ; 10	55,6	32,7	12,6	6	18	1	36,36	1,52	8592667124363
4CZ-HKL13	13	80,1	40,2	17,8	6	12	1	47,93	2,00	8592667124370
4CZ-HKL16	16	85,2	44,9	21,2	8	64	1	73,55	3,06	8592667124387
4CZ-HKL20	20	118	59	25,4	9	178	1	119,83	4,99	8592667687523

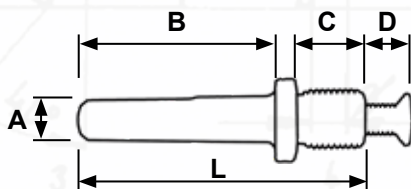

Redukce na skličidlo vrtačkové SDS+ na závit 1/2"-20UNF
Adapter for drill chuck with SDS-Plus shank to 1/2"-20UNF
Adapter für Bohrfutter mit SDS-Pluschaft auf 1/2"-20UNF

kód/Code Bestellnummer	L (mm)	A (mm)	B (mm)	C (mm)	D (mm)	W (g)		DPC/RRP (Kč/czk)	DPC/RRP (EUR)	EAN13
4CZ-HRSDSP	64,6	10	45	14,4	20	42	1	98,35	4,10	8592667124400



i Při použití přiklepu používejte pouze skličidla vhodná pro přiklepové vrtačí.
When using impact tools, use only chucks suitable for impact drilling.
Bei Verwendung des Schlags benutzen Sie nur Bohrfutter, die für Schlagbohren geeignet sind.

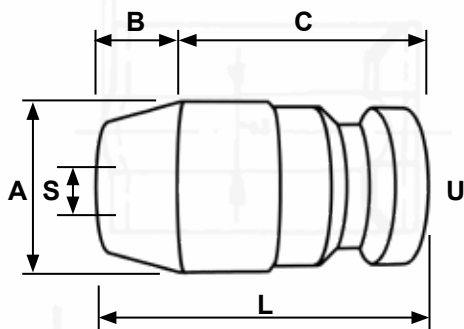

ČSN 241323

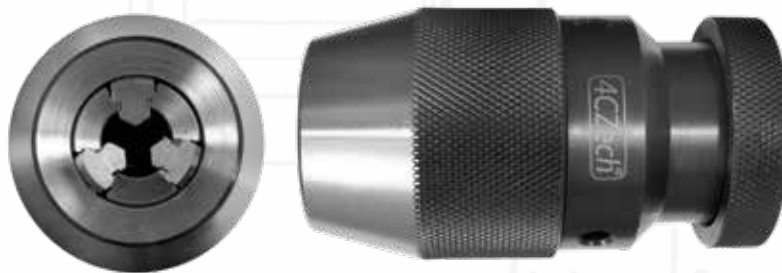

Skličidlo vrtačkové rychloupínací kovové strojní, s kuzelem/se závitem
High-performance drill chuck self-tightening, metal, with taper/thread
Selbstspannendes Hochleistungs-Bohrfutter Metall, mit konus/gewinde

kód/Code Bestellnummer	S (mm)	L (mm)	A (mm)	B (mm)	C (mm)	U	H (mm)	W (g)		DPC/RRP (Kč/czk)	DPC/RRP (EUR)	EAN13
4CZ-H06RS-B10	0,5-6	63,6	35,2	11,8	51,8	B10	< 0,12	320	1	1060,33	44,18	8592667124059
4CZ-H06RS-B12	0,5-6	65,1	35,2	12,1	53	B12	< 0,12	320	1	1083,47	45,14	8592667124066
4CZ-H08RS-B12	0-8	67,4	35,2	13,4	54	B12	< 0,12	340	1	1083,47	45,14	8592667124073
4CZ-H10RS-B12	1-10	83	42,7	15,2	67,8	B12	< 0,12	650	1	1138,84	47,45	8592667124158
4CZ-H10RS-B16	1-10	83	43	15,2	67,8	B16	< 0,12	650	1	1138,84	47,45	8592667124165
4CZ-H13RS-1/2	1,5-13	92,7	48,3	28,5	68,7	1/2" 20UNF	< 0,35	1000	1	1214,88	50,62	8592667124257
4CZ-H13RS-B16	1,5-13	92,7	48,3	22,7	70	B16	< 0,12	1000	1	1214,88	50,62	8592667124264
4CZ-H16RS-B16	3-16	105	52,8	19	86	B16	< 0,12	1420	1	1342,15	55,92	8592667124318
4CZ-H16RS-B18	3-16	105	52,6	19	86	B18	< 0,12	1400	1	1342,98	55,96	8592667124325
4CZ-H20RS-B22	5-20	118	58,1	22	86	B22	< 0,12	1900	1	1534,71	63,95	8592667124356

kužel
taper
Konus

závit
thread
Gewinde





Kód / Code / Bestellnummer
SM-D29, 4CZ-HT-MK

Industry
line

ISO
239

DIN
238

ČSN
241329



POUŽITÍ

Trn pro upnutí vrtačkových sklíčidel s vnitřním kuželem B10 až B24 a se závitem 1/2"-20UNF až 5/8"-16UNF, do vřeten strojů s upínacím morse kuželem Mk1 až Mk 5. Pro upnutí do vřetene stroje lze kombinovat s redukčními pouzdry ČSN 241240 a ČSN 241245.



USABILITY

Morse taper drill chuck arbor B10 to B24 and with thread 1/2"-20UNF to 5/8"-16UNF for machine spindles with Morse taper Mk1 to Mk 5. For clamping in the machine spindle it can be combined with reduction sleeves ČSN 241240 and ČSN 241245.



VERWENDUNG

Spanndorn zum Spannen von Bohrfuttern mit Innenkegel B10 bis B24 und Gewinde 1/2"-20UNF bis 5/8"-16UNF, in den Maschinenspindeln mit Morsekegel Mk1 bis Mk 5. Zum Spannen in der Maschinenspindel kombinierbar mit Reduzierhülsen ČSN 241240 und ČSN 241245.

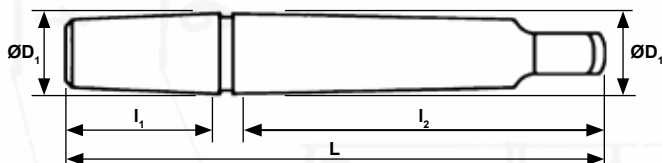

ISO 239
DIN 238
ČSN 241329

Trn pro vrtačková sklíčidla
Taper Mandrel for drill chucks
Kegeldorne für Bohrfutter

kód/Code Bestellnummer	Stopka	Morse	ØD1 (mm)	ØD2 (mm)	I1 (mm)	I2 (mm)	L (mm)	W (g)		DPC/RRP (Kč/czck)	DPC/RRP (EUR)	EAN13
SM-D291000F000S	B 10	0	10,09	9,1	18	59	79	33	1	285,12	11,88	8592667433823
SM-D291001F000S	B 10	1	10,09	12,07	14,5	62	86	60	1	269,42	11,23	8592667392465
SM-D291002F000S	B 10	2	10,09	17,78	14,5	75	102	150	1	199,17	8,30	8592667392472
SM-D291201F000S	B 12	1	12,07	12,07	18,5	62	90	62	1	271,07	11,29	8592667392489
SM-D291202F000S	B 12	2	12,07	17,78	18,5	75	105	128	1	196,69	8,20	8592667392496
SM-D291203F000S	B 12	3	12,07	23,83	18,5	94	124	286	1	256,20	10,67	8592667392502
SM-D291601F000S	B 16	1	15,73	12,07	24	62	97	87	1	282,64	11,78	8592667392519
SM-D291602F000S	B 16	2	15,73	17,78	24	75	112	161	1	202,48	8,44	8592667392526
SM-D291603F000S	B 16	3	15,73	23,83	24	94	133	320	1	261,16	10,88	8592667392533
SM-D291604F000S	B 16	4	15,73	31,27	24	117,5	159	625	1	437,19	18,22	8592667438071
SM-D291801F000S	B 18	1	17,78	12,07	32	62	106	115	1	299,17	12,47	8592667392540
SM-D291802F000S	B 18	2	17,78	17,78	32	75	120	188	1	205,79	8,57	8592667392557
SM-D291803F000S	B 18	3	17,78	23,83	32	94	140	341	1	263,64	10,98	8592667392564
SM-D291804F000S	B 18	4	17,78	31,27	32	117,5	159	625	1	455,37	18,97	8592667441033
SM-D292202F000S	B 22	2	21,79	17,78	40,5	75	128	234	1	242,15	10,09	8592667392571
SM-D292203F000S	B 22	3	21,79	23,83	40,5	94	147	343	1	281,82	11,74	8592667392588
SM-D292204F000S	B 22	4	21,79	31,27	40,5	117,5	175	702	1	472,73	19,70	8592667392595
SM-D292403F000S	B 24	3	23,83	23,83	50,5	94	157	513	1	219,01	9,13	8592667392601
SM-D292404F000S	B 24	4	23,83	31,27	50,5	117,5	186	790	1	310,74	12,95	8592667392618
SM-D292405F000S	B 24	5	23,83	44,40	50,5	149,5	221	1680	1	517,36	21,56	8592667433830

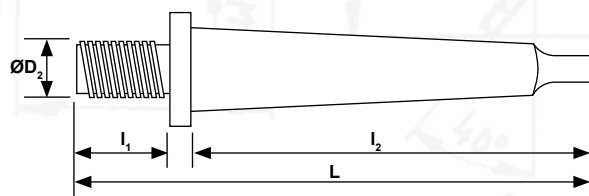

ISO 239
ČSN 241329

Trn pro vrtačková sklíčidla
Taper Mandrel for drill chucks
Kegeldorne für Bohrfutter

kód/Code Bestellnummer	Stopka	Morse	ØD2 (mm)	I1 (mm)	I2 (mm)	L (mm)	W (g)		DPC/RRP (Kč/czck)	DPC/RRP (EUR)	EAN13
4CZ-HT-MK1-1/2	1/2"-20UNF	1	12,07	16	62	88	79	1	325,62	13,57	8592667180963
4CZ-HT-MK2-1/2	1/2"-20UNF	2	17,78	16	76	100	146	1	273,55	11,40	8592667180970
4CZ-HT-MK2-3/8	3/8"-24UNF	2	17,78	13,5	76	97	145	1	273,55	11,40	8592667180987
4CZ-HT-MK3-1/2	1/2"-20UNF	3	23,83	16	97	119	300	1	337,19	14,05	8592667180994
4CZ-HT-MK4-5/8	5/8"-16UNF	4	31,27	18,5	124	145	620	1	484,30	20,18	8592667181007



Kód / Code / Bestellnummer

SM-D40, SM-D45

Industry
line

DIN
2185

DIN
2187

ČSN
241240

ČSN
241245



POUŽITÍ

Redukční pouzdra s morse kuželem pro upínání nástrojů s morse kuželovou stopkou do vřetene stroje.



USE

Morse taper sleeves for clamping tools with a Morse taper shank to the machine spindle.



VERWENDUNG

Reduktionshülse mit Morsekegel zum Spannen von Werkzeugen mit Morsekegelschaft an der Maschinenspindel.

Redukční pouzdro ČSN 241240, DIN2185
Morse taper sleeve CSN 241240, DIN2185
Reduktionshülse ČSN 241240, DIN2185

kód/Code Bestellnummer	MK vnější MK outside MK Außen	MK vnitřní MK inner MK Innen	Ød1 (mm)	Ød2 (mm)	L (mm)	W (g)		DPC/RRP (Kč/czk)	DPC/RRP (EUR)	EAN13
SM-D400100F000S	1	0	12,065	9,045	85	40	1	262,81	10,95	8592667392625
SM-D400201F000S	2	1	17,780	12,056	92	92	1	220,66	9,19	8592667392632
SM-D400301F000S	3	1	23,825	12,056	99	209	1	262,81	10,95	8592667392649
SM-D400302F000S	3	2	23,825	17,780	112	182	1	291,74	12,16	8592667392656
SM-D400401F000S	4	1	31,276	12,056	124	516	1	372,73	15,53	8592667392663
SM-D400402F000S	4	2	31,276	17,780	124	440	1	374,38	15,60	8592667392670
SM-D400403F000S	4	3	31,276	23,825	140	385	1	372,73	15,53	8592667392687
SM-D400501F000S	5	1	44,399	12,056	156	1412	1	588,43	24,52	8592667392694
SM-D400502F000S	5	2	44,399	17,780	156	1331	1	588,43	24,52	8592667392700
SM-D400503F000S	5	3	44,399	23,825	156	1166	1	588,43	24,52	8592667392717
SM-D400504F000S	5	4	44,399	31,276	171	1007	1	599,17	24,97	8592667392724
SM-D400602F000S	6	2	63,348	17,780	218	3973	1	1478,51	61,60	8592667433847
SM-D400603F000S	6	3	63,348	23,825	218	3807	1	1478,51	61,60	8592667392731
SM-D400604F000S	6	4	63,348	31,276	218	3452	1	1511,57	62,98	8592667392748
SM-D400605F000S	6	5	63,348	44,399	218	2513	1	1478,51	61,60	8592667392755

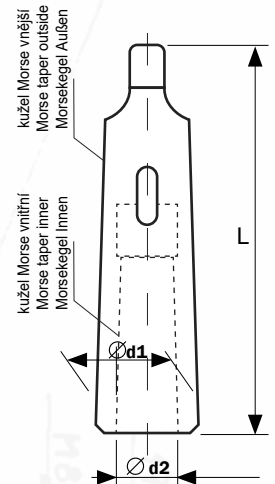

Redukční pouzdro prodloužené ČSN 241245, DIN2187
Morse taper sleeve extended CSN 241245, DIN2187
Reduktionshülse verlängert ČSN 241245, DIN2187

kód/Code Bestellnummer	MK vnější MK outside MK Außen	MK vnitřní MK inner MK Innen	Ød1 (mm)	Ød2 (mm)	d (mm)	L (mm)	l (mm)	W (g)		DPC/RRP (Kč/czk)	DPC/RRP (EUR)	EAN13
SM-D450101F000S	1	1	12,065	12,065	20	145	80	182	1	415,70	17,32	8592667488281
SM-D450201F000S	2	1	17,780	12,065	20	160	80	260	1	461,16	19,21	859266751846
SM-D450202F000S	2	2	17,780	17,780	30	180	100	498	1	531,40	22,14	8592667143258
SM-D450301F000S	3	1	23,825	12,065	20	175	76	395	1	611,57	25,48	8592667503380
SM-D450302F000S	3	2	23,825	17,780	30	194	95	641	1	611,57	25,48	8592667503397
SM-D450303F000S	3	3	23,825	23,825	36	240	141	876	1	706,61	29,44	8592667499942
SM-D450401F000S	4	1	31,276	12,065	20	205	81	712	1	877,69	36,57	8592667503403
SM-D450402F000S	4	2	31,276	17,780	30	215	91	940	1	789,26	32,89	8592667503410
SM-D450403F000S	4	3	31,276	23,825	36	260	136	1185	1	789,26	32,89	8592667499959
SM-D450404F000S	4	4	31,276	31,276	48	280	156	1880	1	1093,39	45,56	8592667484436
SM-D450501F000S	5	1	44,399	12,065	20	235	80	1606	1	1352,07	56,34	8592667615809
SM-D450502F000S	5	2	44,399	17,780	30	250	95	1831	1	1333,06	55,54	8592667143265
SM-D450503F000S	5	3	44,399	23,825	36	268	112	2095	1	1533,06	63,88	8592667143272
SM-D450504F000S	5	4	44,399	31,276	48	300	145	2850	1	1762,81	73,45	8592667143289
SM-D450505F000S	5	5	44,399	44,399	63	335	172	4142	1	2099,17	87,47	8592667520318
SM-D450604F000S	6	4	63,348	31,276	48	355	137	5475	1	3008,26	125,34	8592667143296
SM-D450605F000S	6	5	63,348	44,399	63	390	172	6713	1	3073,55	128,06	8592667481466

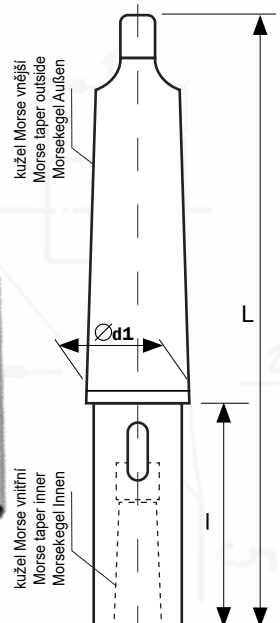

Redukční pouzdro prodloužené ČSN 241245, DIN2187 obrácené
Morse taper sleeve extended CSN 241245, DIN2187 reversed
Reduktionshülse verlängert ČSN 241245, DIN2187 verkehrt

kód/Code Bestellnummer	MK vnější MK outside MK Außen	MK vnitřní MK inner MK Innen	Ød1 (mm)	Ød2 (mm)	d (mm)	L (mm)	l (mm)	W (g)		DPC/RRP (Kč/czk)	DPC/RRP (EUR)	EAN13
SM-D450102F000S	1	2	12,065	17,780	30	160	80	417	1	461,16	19,21	8592667573567
SM-D450203F000S	2	3	17,780	23,825	36	200	120	728	1	575,21	23,97	8592667503014
SM-D450304F000S	3	4	23,825	31,276	48	240	141	1574	1	837,19	34,88	8592667503021
SM-D450405F000S	4	5	31,276	44,399	63	300	176	3168	1	2154,55	89,77	8592667481459



Kód / Code / Bestellnummer

241279

Industry
line

ČSN
241279



POUŽITÍ

Vyrážecí klíny pro nástroje s unašecím morse kuželem. Klín zasuněte do šterbiny vřetene a úderem kladiva uvolněte nástroj.



USE

Key drivers for tools with Morse taper. Insert the driver into the spindle slot and release the tool with a hammer.



VERWENDUNG

Austreiber für Werkzeuge mit Morsekegel. Den Austreiber in den Spindelschlitz einführen und das Werkzeug mit einem Hammer lösen.

Klín vyrážecí ČSN 241279
Key driver CSN 241279
Austreiber ČSN 241279

kód / Code Bestellnummer	velikost Size Größe	pro kužel Morse For Morse taper Für Morsekegel	pro ISO For ISO Für ISO	W (g)		DPC/RRP (Kč/czk)	DPC/RRP (EUR)	EAN13
241279-0	0	0		18	1	100,00	4,17	8592667306691
241279-1	1	1 ; 2		62	1	121,00	5,04	8592667306707
241279-3	3	3 ; 4		152	1	180,00	7,50	8592667306714
241279-5	5	5 ; 6	80,0	660	1	370,00	15,42	8592667306721
241279-7	7		100 - 160	2726	1	498,00	20,75	8592667306738

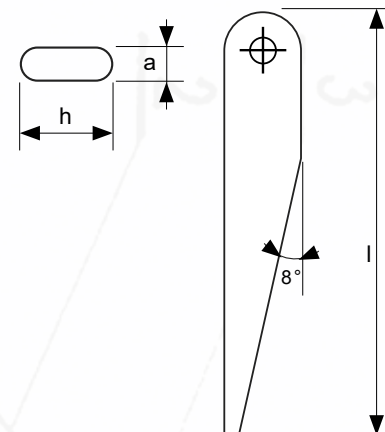



Kód / Code / Bestellnummer

BW-T

Industry
line



POUŽITÍ

Lišta z hliníkového profilu do T drážky. Použití: Žádné další náročné čištění drážek ve stole stroje, pokud byla volná část drážky předem zakryta lištou. Krycí lišty lze po ukončení prací snadno odstranit. Lišty lze pomocí jemného pilového listu snadno upravit na požadovanou délku. Dodáváno v délkách 300, 400, 450, 500 a 1000 mm.



USABILITY

Aluminium profile strip. Application: Laborious cleaning of table slots is no longer necessary if empty slots are covered up with cover strips beforehand. Cover strips can easily be removed after machining. Cutting to the required length is possible using a fine saw blade. Supplied in lengths of 300, 400, 450, 500 and 1000 mm.



VERWENDUNG

Aluminiumprofilleiste. Verwendung: Kein aufwändiges nachträgliches Reinigen der Maschinentisch-Nut mehr notwendig, wenn die freie Nut zuvor mit der Abdeckleiste abgedeckt wurde. Die Abdeckleisten lassen sich nach der Bearbeitung mühelos entfernen. Das Schneiden auf die gewünschte Länge ist mit einem feinem Sägeblatt problemlos möglich. Geliefert in Längen von 300, 400, 450, 500 und 1000 mm.

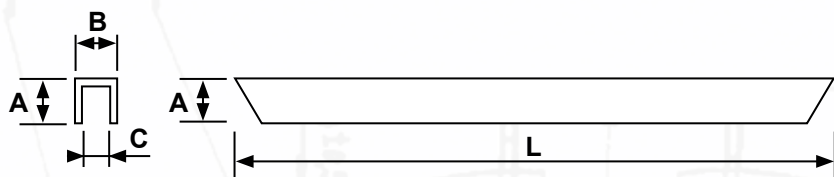

Hliníková lišta do T drážky
 Aluminium cover strip for T-slot
 Aluminium Abdeckleiste für T-nut

kód/Code Bestellnummer	A (mm)	B (mm)	C (mm)	L (mm)	W (g)		DPC/RRP (Kč/czk)	DPC/RRP (EUR)	EAN13
BW-T10-300	8	10	5	300	126	6	895,04	37,29	8592667632578
BW-T12-400	8	12	6	400	198	6	895,04	37,29	8592667632585
BW-T14-400	10	14	6	400	324	6	895,04	37,29	8592667632592
BW-T16-400	12	16	9	400	402	6	1072,73	44,70	8592667632608
BW-T18-450	12	18	11	450	456	6	1072,73	44,70	8592667632622
BW-T18-1000	12	18	11	1000	825	5	2681,82	111,74	8592667632615
BW-T20-500	13	20	13	500	840	10	2681,82	111,74	8592667632646
BW-T20-1000	13	20	12	1000	855	5	2681,82	111,74	8592667632639
BW-T22-1000	13	22	15	1000	895	5	2681,82	111,74	8592667632653
BW-T24-1000	14	24	17	1000	1060	5	2681,82	111,74	8592667632660
BW-T28-1000	14	28	21	1000	1210	5	3128,93	130,37	8592667632677
BW-T36-1000	14	36	28	1000	1235	5	3575,21	148,97	8592667632684

(Cena je za celé balení)
 (The price is for the whole package)
 (Der Preis gilt für das Gesamtpaket)

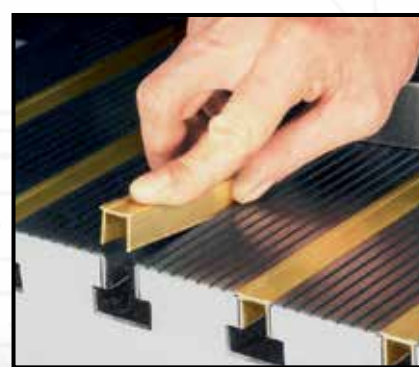
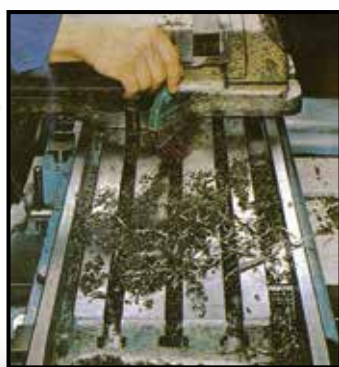



FIRMA NÁSTROJE CZ, S.R.O. JE VÝROBNĚ OBCHODNÍ FIRMA ZABÝVAJÍCÍ SE I VÝROBOU VRTÁKŮ, ZÁVITNÍKŮ A BRUSIVA. O OBSÁHLÝ KATALOG VYRÁBĚNÉHO SORTIMENTU SI ZAVOLEJTE NA +420 777 581 299 (OBJEDNAVKY@NASTROJECZ.CZ).

COMPANY NÁSTROJE CZ, S.R.O. OPERATES AS A PRODUCTION AND BUSINESS COMPANY WITH OWN PRODUCTION OF TWIST DRILLS, TAPS AND ABRASIVE. IF YOU WOULD LIKE TO HAVE OUR EXTENSIVE CATALOGUE WITH OUR GOODS, CALL THE PHONE NUMBER +420 775 862 527 (EXPORT@NASTROJECZ.CZ).

DIE FIRMA NÁSTROJE CZ, S.R.O. IST EIN HERSTELLUNGS- UND HANDELSUNTERNEHMEN, DAS SICH AUCH MIT DER PRODUKTION VON BOHRERN, GEWINDEBOHRERN UND SCHLEIFMITTELN BESCHÄFTIGT. DEN UMFANGREICHEN SORTIMENTS KATALOG KÖNNEN SIE UNTER +420 775 862 527 ANFORDERN (EXPORT@NASTROJECZ.CZ).



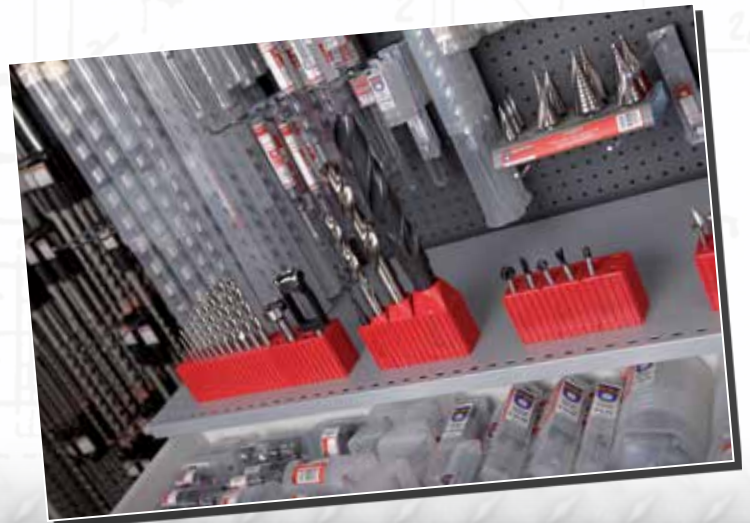



OBJEDNÁVKA / ORDER / BESTELLUNG:

Telefonicky: pondělí – pátek od 8.00 do 17.00 hod.
By telephone: Monday - Friday from 8 until 17 o'clock.
Telefonisch: Montag - Freitag von 8.00 bis 17.00 Uhr.
+420 491 615 785, +420 777 581 299
+420 775 862 527, +420 725 578 814

Fax: (nepřetržitě / continuously / durchgehend):
+420 491 615 789

E-mail (nepřetržitě / continuously / durchgehend):
objednavky@nastrojecz.cz
orders@nastrojecz.cz
export@nastrojecz.cz

Eshop: eshop.nastrojecz.cz
Internet (nepřetržitě / continuously / durchgehend):
www.nastrojecz.cz
www.4czech.eu

- Zboží po území České republiky a Slovenska je zasláno prostřednictvím zásilkové služby PPL. Zboží dodáváme do 1-3 dnů, pokud je skladem. Nedodané zboží evidujeme, až do úplného vykrytí.
- K objednávkám je účtován expediční poplatek ve výši 90 Kč (3,80 EUR) bez DPH.
- Objednávky nad 5000 Kč (210 EUR) jsou dodávány bez poplatku. Po dohodě je možné vyzvednout zboží osobně ve Ždánicích v expedici. Dodávky zboží jsou hrazeny na dobírku, v hotovosti při převzetí, nebo platbou předem.
- Splatnost je nutné dohodnout s obchodními zástupci. V případě neuhrazených faktur po splatnosti, jsou další zásilky zaslány hotově nebo nebudou odeslány, až do doplacení dlužných částek.
- Rozdíly v dodávkách je nutné nahlásit písemně nejdéle do 24 hodin od převzetí zásilky na e-mail: expedice@nastrojecz.cz nebo na fax: +420 515 553 609. Poškozenou zásilku odmítněte, nebo sepište protokol o závadě s dopravcem a písemně nás informujte. Pouze za těchto podmínek je možné sjednat nápravu.
- Reklamací zboží lze uplatnit pouze v záruční době. Reklamační proces se řídí platnými zákony ČR a SK. Reklamované zboží musí být doprovázeno reklamačním listem, který musí obsahovat název reklamovaného zboží, nejlépe kód výrobce, datum zaslání reklamacie, popis závady, množství reklamovaného zboží, kompletní údaje o kupujícím a kontaktní jméno pro vyřízení reklamacie.
- Zahraniční dodací a platební podmínky se řeší individuálně na základě kupní smlouvy.
- The goods is delivered via the delivery company PPL in the Czech Republic and Slovakia. The goods is delivered within 1-3 days if it is on stock. We register the undelivered goods till the complete order fulfillment.
- We charge a delivery fee of 90 CZK (3,80 EUR) excluding VAT.
- The orders with the amount more than 5000 CZK (210 EUR) are delivered free of charge. The goods can be picked up in person in our expedition in Ždánice upon an agreement. The shipment can be paid by cash on delivery, in cash in case of personal pick-up or by bank transfer.
- The maturity date should be arranged with a salesman. In case of unpaid overdue invoices, the goods will be sent by cash on delivery or they will be sent after the payment of the sum owed.
- In case of delivery errors, it is necessary to announce them in written form by e-mail: expedice@nastrojecz.cz or by fax +420 515 553 609 not longer than 24 hours from shipment receipt. Refuse the damaged shipment, or write a report about the defect with a forwarder and let us know in written form. It is possible to rectify the problem only under these conditions.
- A complaint of the goods can be lodged only in a guarantee period. The complaint process is followed by valid laws in the Czech Republic and Slovakia. The complaint goods must be accompanied with a complaint list which must contain this information: description of the complaint goods, preferable the code of a supplier, date of complaint, defect description, quantity of the complaint goods, complete data about a purchaser and a contact name for handling the complaint.
- Foreign delivery and payment conditions are dealt individually on the basis of a purchase contract.
- Innerhalb der Tschechischen Republik und der Slowakei wird Ware mit dem Paketdienst PPL versendet. Die Ware liefern wir innerhalb von 1 bis 3 Tagen, wenn sie auf Lager ist. Nicht gelieferte Ware wird bis zur vollständigen Auslieferung erfasst.
- Zu den Bestellungen wird eine Versandgebühr in der Höhe von 90 CZK (3,80 EUR) ohne MwSt. berechnet.
- Die Bestellungen mit einem Bestellwert von mehr als 5000 CZK (210 EUR) werden frei Haus geliefert. Nach Absprache ist es möglich, die Ware persönlich in der Auslieferung in Ždánice abzuholen. Die Warenlieferungen werden per Nachnahme, in bar bei der Übernahme oder per Vorkasse bezahlt.
- Die Fälligkeitsfristen müssen mit Ihren Außendienst-Ansprechpartnern vereinbart werden. Bei nicht bezahlten fälligen Rechnungen müssen weitere Sendungen in bar bezahlt werden oder werden gar nicht versendet - bis zur Begleichung der Schuldbeträge.
- Die Unterschiede in den Lieferungen muss man spätestens bis 24 Stunden von der Sendungsübernahme per Email expedice@nastrojecz.cz oder per Fax +420 515 553 609 schriftlich melden. Eventuell beschädigte Sendungen lehnen Sie entweder ab, oder verfassen Sie mit dem Spediteur ein Protokoll über festgestellte Mängel und informieren Sie uns schriftlich. Nur unter diesen Bedingungen ist es möglich, Abhilfe zu schaffen.
- Eventuelle Reklamationsansprüche zur Ware kann man nur in der Garantiefrist geltend machen. Das Reklamationsverfahren richtet sich nach den geltenden Gesetzen in der Tschechischen Republik und der Slowakei. Zu reklamierter Ware muss ein Reklamationschein beigelegt sein. Dieser muss Folgendes enthalten: Bezeichnung der reklamierten Ware, am besten den Herstellungscode, Datum der Reklamationsendung, Beschreibung der Fehler, reklamierte Menge, vollständige Käuferangaben und den Kontaktnamen für Reklamationserledigung.
- Die ausländischen Liefer- und Zahlungsbedingungen werden individuell auf Grund eines Kaufvertrags geregelt.

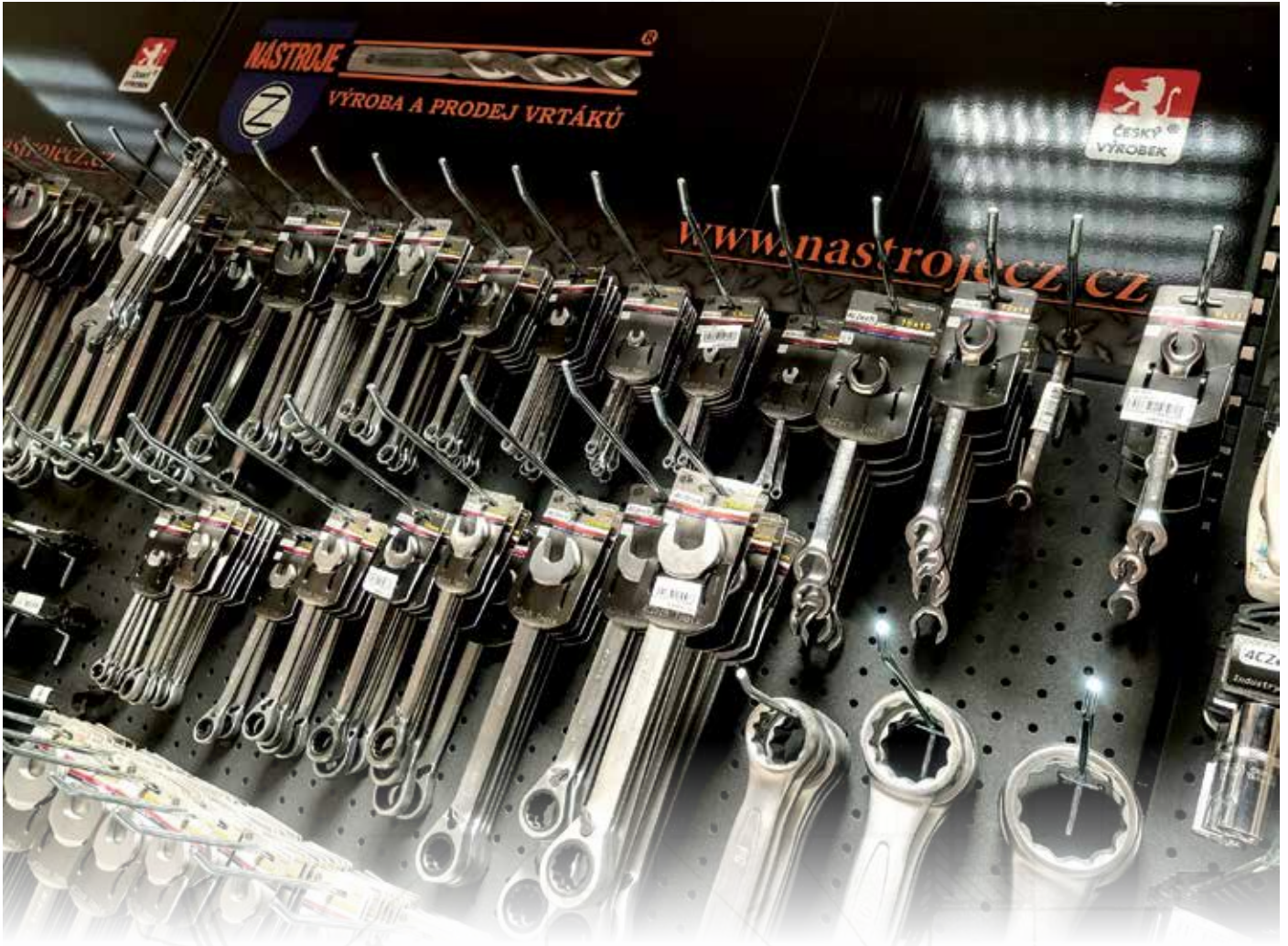



NÁSTROJE CZ, s.r.o.

Riegrova 399, 697 01 Kyjov, Czech Republic

IČO / Identification Number / Handelsregister-Nummer: 27674207

DIČ - VAT / Tax Registration Number - VAT / Umsatzsteuernummer - VAT: CZ27674207



nastrojecz



NÁSTROJE CZ, s.r.o.

Bankovní spojení / Bank connection / Bankverbindung:

ČSOB BusinessBanking 24

Číslo účtu / Account number / Kontonummer:

243442372 / 0300 USD

NÁSTROJE CZ, S.R.O.

CZ74 0300 0000 0002 4344 2372

SWIFT (BIC) CEKOCZPP

ČSOB BusinessBanking 24

Číslo účtu / Account number / Kontonummer:

212924416 / 0300 CZK

NÁSTROJE CZ, S.R.O.

CZ53 0300 0000 0002 1292 4416

SWIFT (BIC) CEKOCZPP

ČSOB Podnikatelské konto

Číslo účtu / Account number / Kontonummer:

4018065214 / 7500 EUR

NÁSTROJE CZ, S.R.O.

IBAN: SK31 7500 0000 0040 1806 5214

SWIFT (BIC) CEKOSKBX

Firma je zapsána v obchodním rejstříku vedeném Krajským soudem v Brně oddíl C, vložka 50899.

The company is registered in commercial register kept by the Brno Regional Court, section C, insert no. 50899.

Die Firma ist im durch das Kreisgericht in Brünn geführten Handelsregister, Teil C, Einlage 50899 eingetragen.



EXPEDICE / SHIPMENT / WARENLIEFERUNG

Expresní přeprava zboží tuzemsko a Slovensko 24h

- zahraničí do 2-5 dnů

Doprava firmou NÁSTROJE CZ, s.r.o. na základě dohody se zákazníkem.

Express shipping: - inland and Slovakia within 24 hours.

- abroad within 2-5 days

The transport arranged by the company NÁSTROJE CZ, s.r.o. is based on agreement with a customer.

Expresslieferung: - Inland und Slovakia bis 24 Stunden.

- Ausland bis 2-5 Tage

Eine Lieferung durch die Firma NÁSTROJE CZ, s.r.o. nach Abstimmung mit Kunden.



Vyhrazujeme právo chyb a změn uvedených cen. / Prices are subject to change. Misprints excepted. / Wir behalten uns das Recht auf Fehler und Änderungen der angeführten Preise vor.

Uvedené ceny jsou DPC (doporučené prodejní ceny) v Kč a EUR bez DPH. Ceny v EUR pouze informativní, mohou se měnit dle aktuálního kurzu.

All prices mentioned are DPC (RRP - recommended retail price) in CZK and EUR without VAT. The Euro prices have only informative character, they can change according to current exchange rate.

Alle Preise sind EV-Preise (empfohlene Verkaufspreise) in CZK und EUR ohne MwSt. Preise in EUR sind nur informativ und hängen vom aktuellen Währungskurs ab.





**NAJDETE NÁS NA FACEBOOKU
YOU CAN FIND US ON FACEBOOK
SIE FINDEN UNS AUF FACEBOOK**

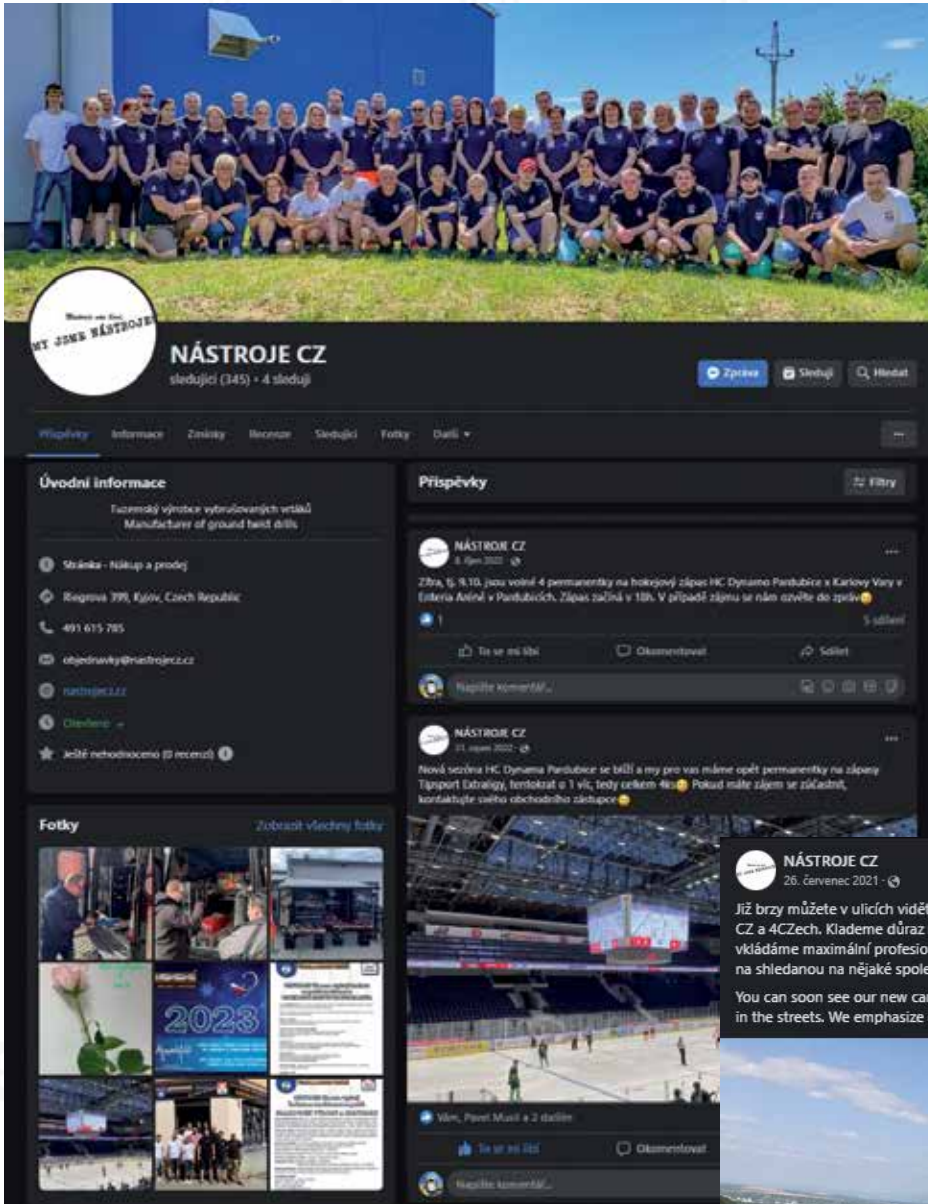

www.facebook.com/nastrojecz/

**ZÁKULISÍ ZE ŽIVOTA
FIRMY, NOVINKY, ...**

**NEWS, OUR COMPANY
BEHIND THE SCENES, ...**

**AKTUELL IN DER FIRMA,
NEUIGKEITEN, ...**

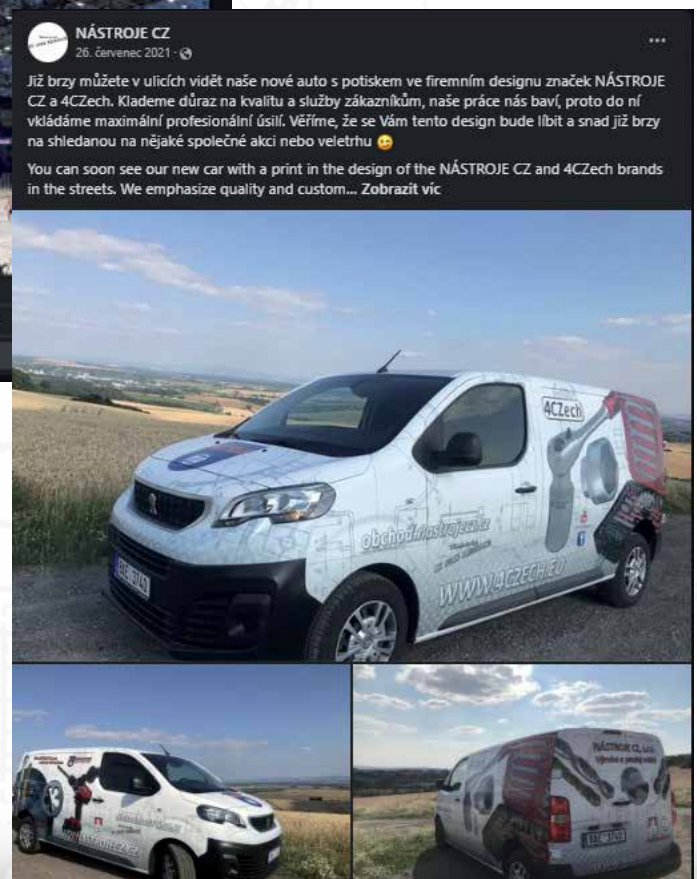



CENY
V KATALOGU
V CZK A EUR
BEZ DPH



NÁSTROJE CZ, s.r.o.
2024 / 2025